

VIGAS RECTAS CONTINUAS,  
ECUACIONES  
ANGULARES, ECUACIÓN DE TRES  
MOMENTOS Y  
APLICACIONES

# Convenciones e Hipótesis

Estructuras compuestas por **vigas rectas**, para simplificar la representación gráfica que tienen el eje de la viga horizontal

- a) Vigas rectas
- b) Materiales elásticos y lineales
- c) Secciones simétricas respecto del eje  $y$ .
- d) Cargas distribuidas  $q$  o concentradas  $P$  según el eje  $y$ .

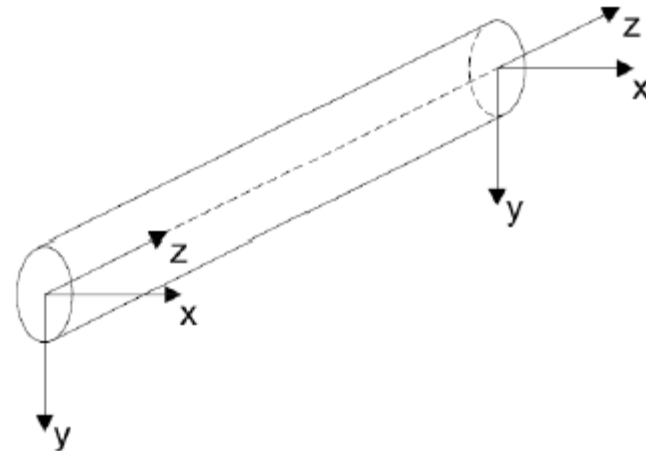

# Vigas rectas hiperestáticas

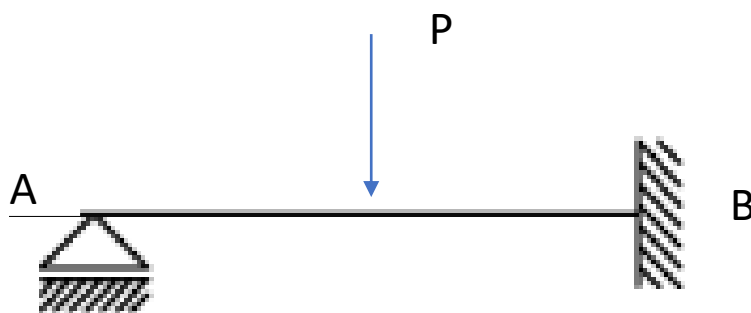

$$\begin{aligned} \text{Sum}(F_v) &= 0 \\ \text{Sum}(M) &= 0 \end{aligned}$$

ángulo de giro en B=0

# Giro en B=0

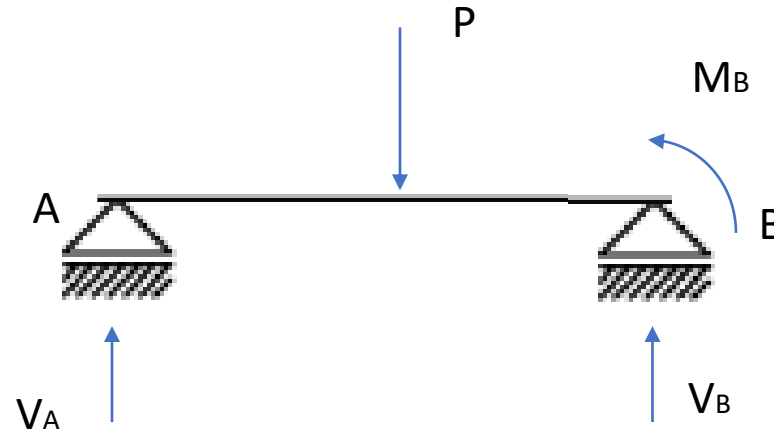

$$\theta_A = \frac{M_0 L}{3EI} \quad \theta_B = \frac{M_0 L}{6EI}$$

$$\theta_{B1} = \frac{M_B L}{3EI}$$

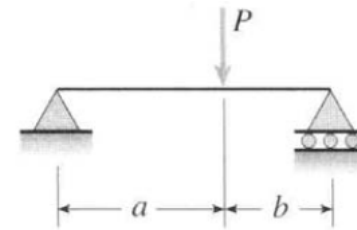

$$\theta_A = \frac{Pab(L+b)}{6LEI}$$

$$\theta_{B2} = \frac{P(L/2)(L/2)(3/2L)}{6L \cdot EI}$$

$$\theta_{B2} = \frac{P(L^2)}{16EI}$$

# Imponemos giro=0 en B

$$\theta_{B1} = M_{BL}/(3EI)$$

$$\theta_{B2} = P(L^3)/(16.L.EI)$$

$$M_{BL}/(3EI) + P(L^2)/(16EI) = 0$$

$$M_B = -3PL/16$$

# Imponemos giro=0 en B

$$\theta_{B1} = M_B L / (3EI)$$

$$\theta_{B2} = P(L^3) / (16.L.EI)$$

$$M_B L / (3EI) + P(L^2) / (16EI) = 0$$

$$M_B = -3PL/16$$

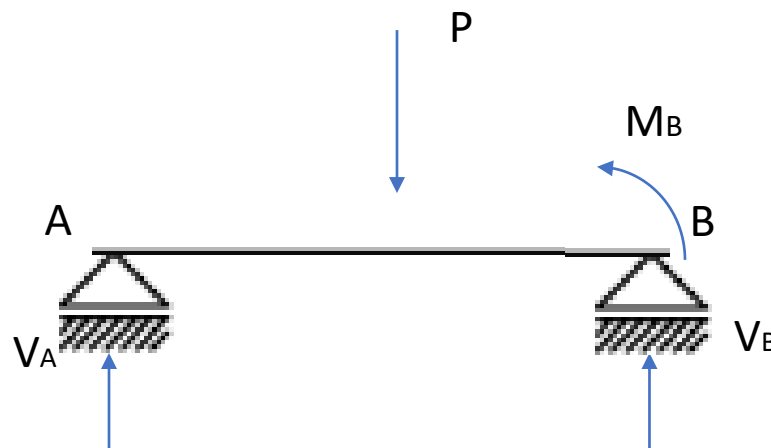

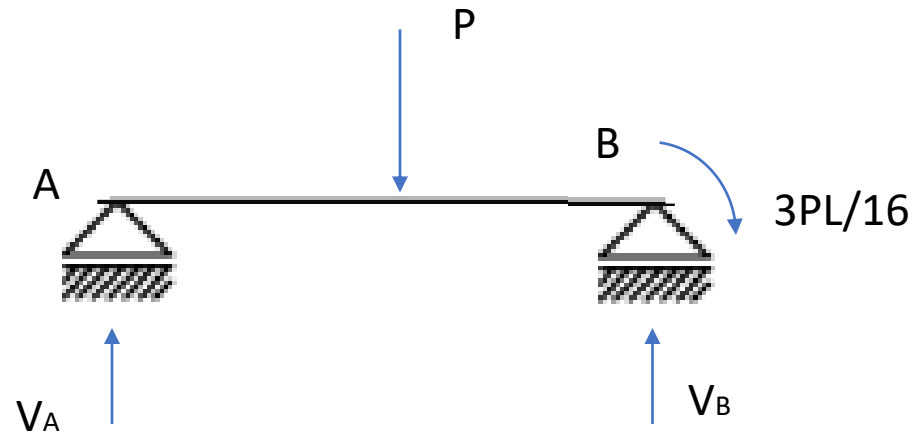

$$V_A + V_B = P$$

$$V_B = P/2 + 3P/16 = 11P/16$$

$$P \cdot L/2 - L \cdot V_B + 3PL/16 = 0$$

$$V_A = P - 11P/16 = 5P/16$$

Trazar Diagramas de V y M

# Giros en apoyos intermedios

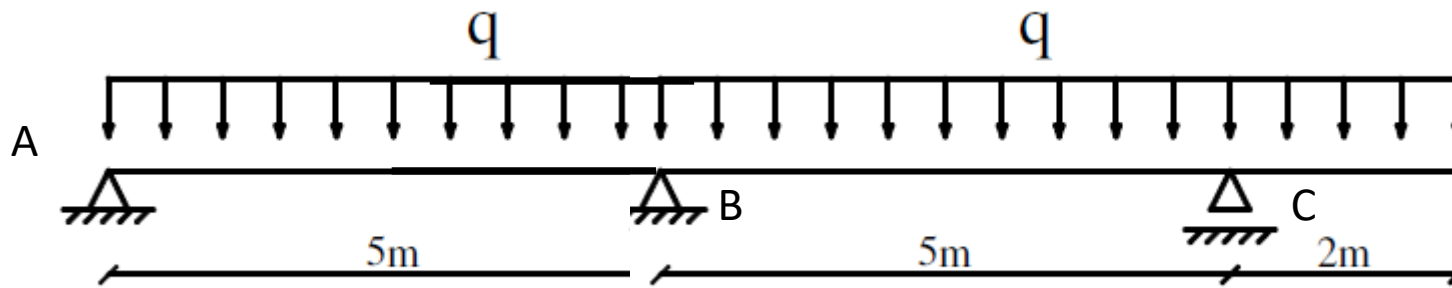



# Continuidad en el giro

$$\theta_n^n + \theta_n^{n+1} = 0$$

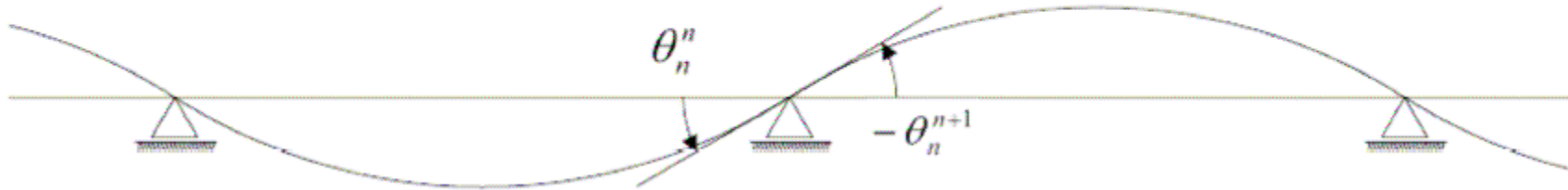

$$\theta_B \text{ izquierda} + \theta_B \text{ derecha} = 0$$

# Giros en apoyos intermedios

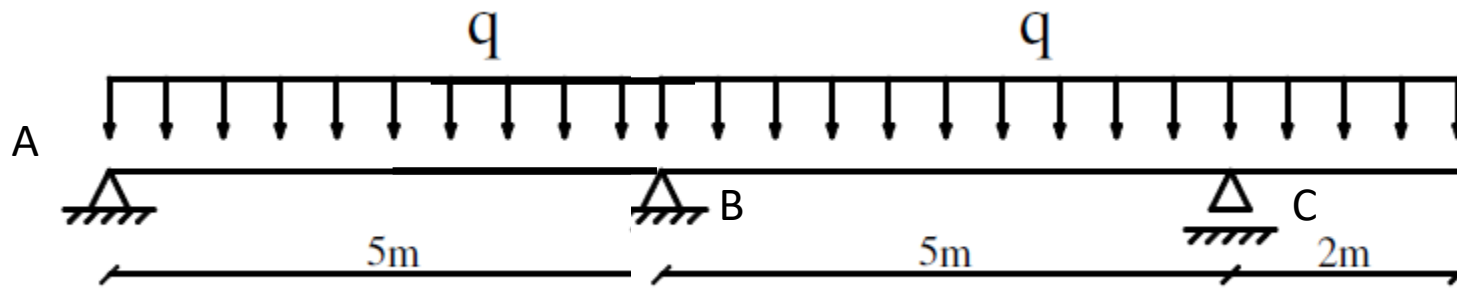

Apoyo B

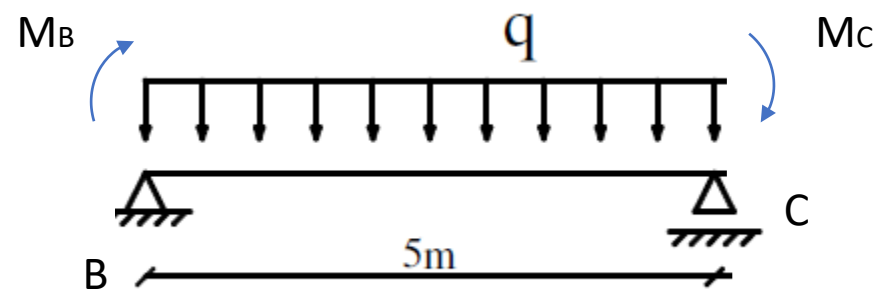
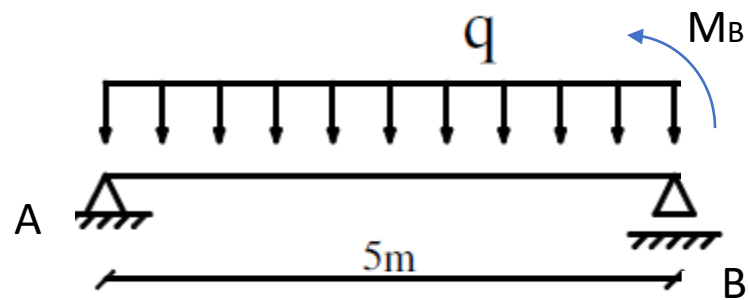

# Equilibrio de un tramo

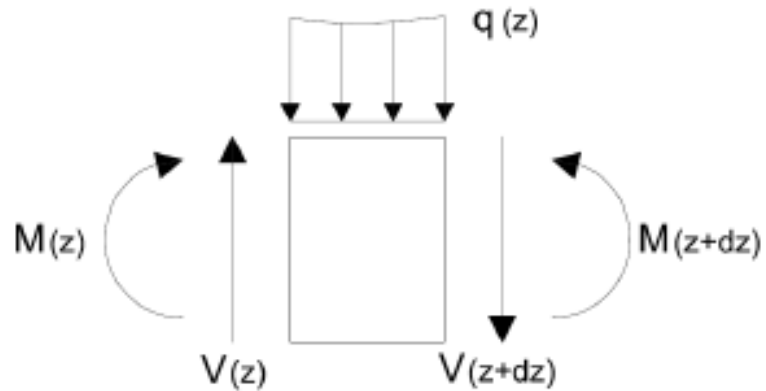

Suma de Fuerzas verticales = 0

$$\frac{dV}{dz} + q(z) = 0$$

Suma de Momentos en  $z+dz = 0$

$$\frac{dM}{dz} = V(z)$$

$$\frac{d^2 M}{dz^2} = \frac{dV}{dz} = -q$$

# Relación Momento-Curvatura

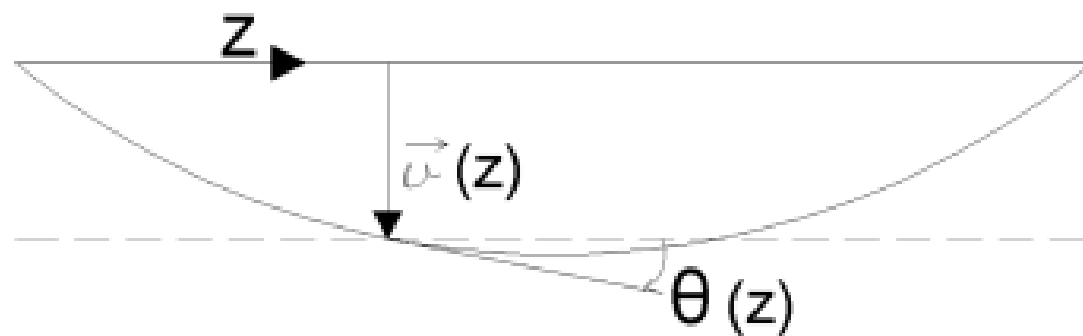

$$\frac{d^2 v}{dz^2} = \frac{d\theta}{dz} = -\frac{M}{EI_x}$$

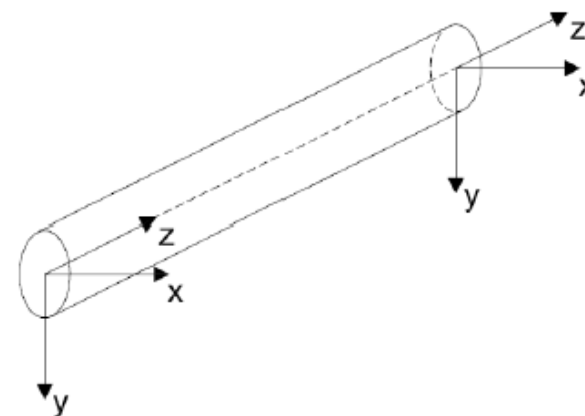

# Analogía de Mohr

$$v \leftrightarrow M$$

$$\theta \leftrightarrow V$$

$$\frac{M}{EI_x} \leftrightarrow q$$

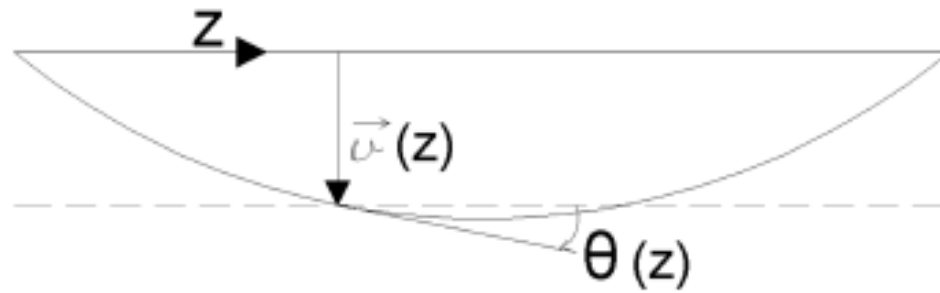

$$v(0) = v(L) = 0$$

$$M(0) = M(L) = 0$$

# Angulos de giro en los apoyos



$$\theta_A = \theta(0)$$

$$\theta_B = -\theta(L)$$

$$v_A = v(0)$$

$$v_B = v(L)$$

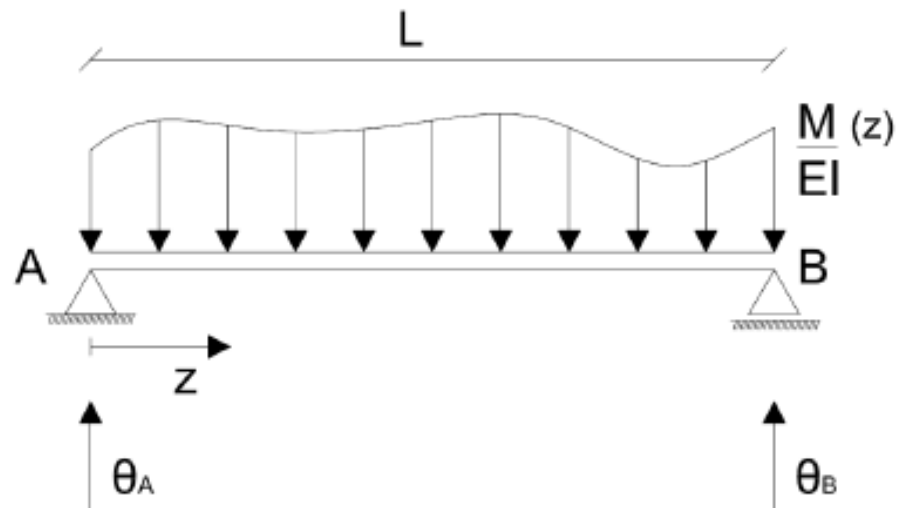

# Analogía de Mohr

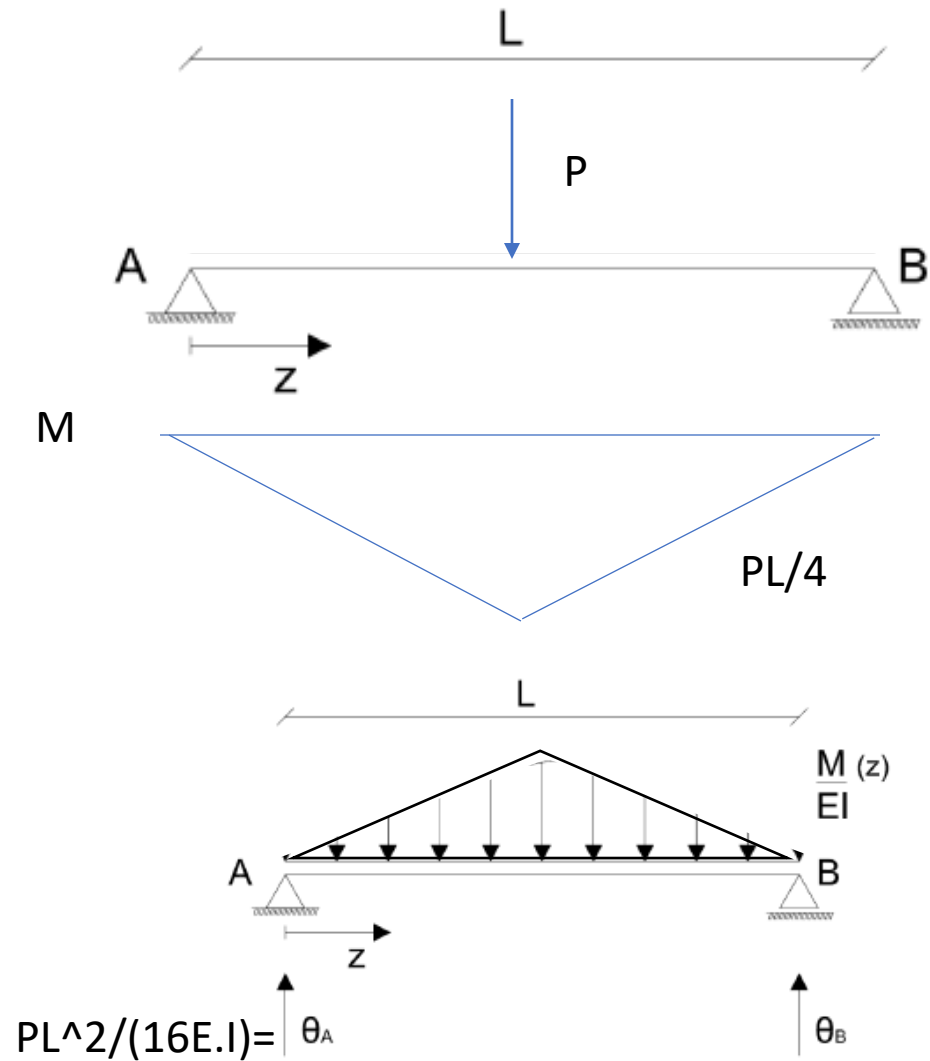

# Reacción en los apoyos

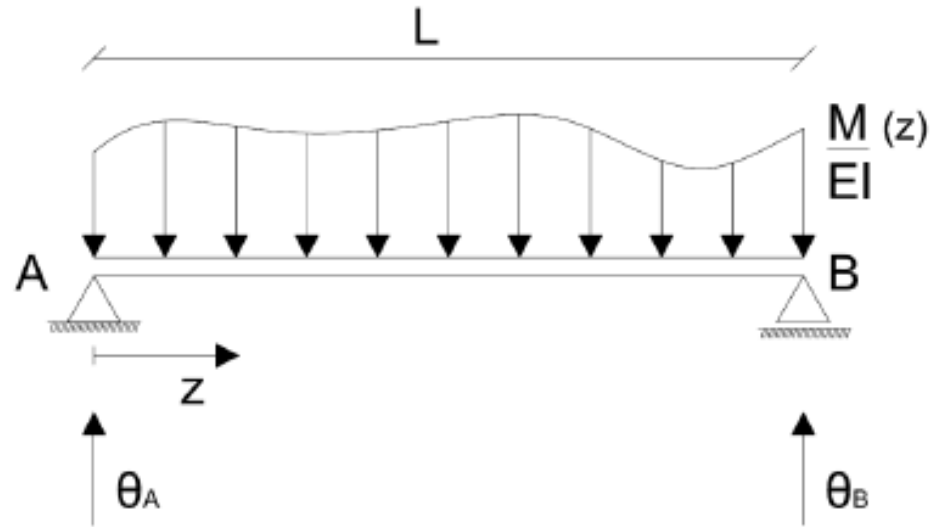

Suma de Momentos en A = 0

$$\theta_B = \frac{1}{L} \int_0^L \frac{M}{EI_x} z dz$$

Suma de Momentos en B = 0

$$\theta_A = \frac{1}{L} \int_0^L \frac{M}{EI_x} (L - z) dz$$



# Considerando una viga S.A.

Para las cargas aplicadas en el vano

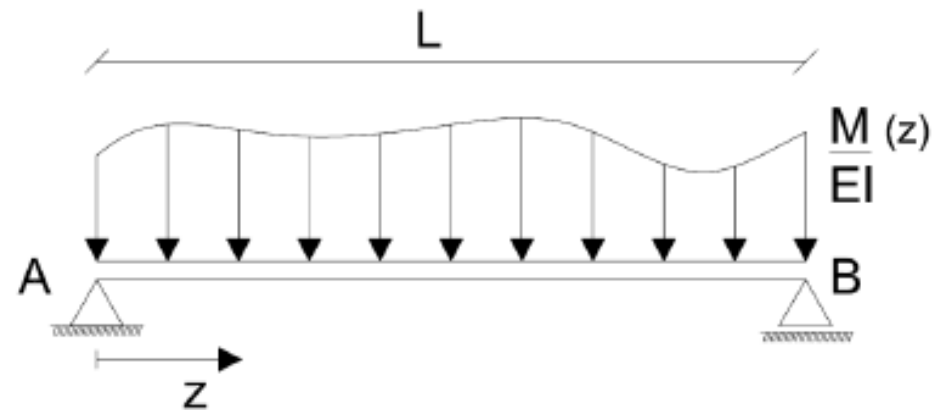

$$\alpha_{0A} = \frac{1}{L} \int_0^L \frac{M}{EI_x} (L - z) dz$$

$$\alpha_{0B} = \frac{1}{L} \int_0^L \frac{M}{EI_x} z dz$$

# Considerando una viga S.A.

- Por ejemplo con carga distribuida  $q$

TABLE G-2 DEFLECTIONS AND SLOPES OF SIMPLE BEAMS

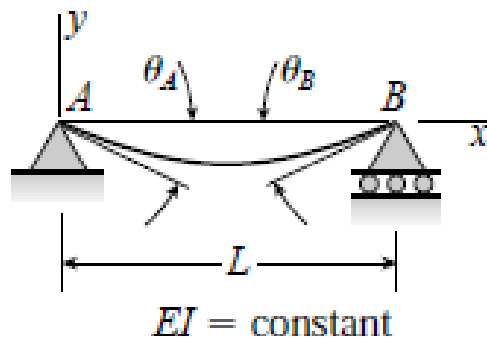

$v$  = deflection in the  $y$  direction

$v' = dv/dx$  = slope of the deflection curve

$\delta_C = -v(L/2)$  = deflection at midpoint  $C$  of the beam

$x_1$  = distance from support  $A$  to point of maximum deflection

$\delta_{\max} = -v_{\max}$  = maximum deflection

$\theta_A = -v'(0)$  = angle of rotation at left-hand end of the beam

$\theta_B = v'(L)$  = angle of rotation at right-hand end of the beam

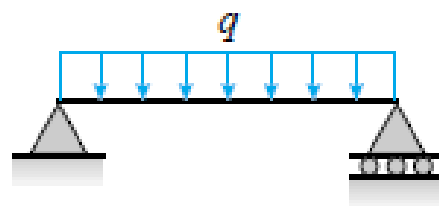

$$v = -\frac{qx}{24EI}(L^3 - 2Lx^2 + x^3)$$

$$v' = -\frac{q}{24EI}(L^3 - 6Lx^2 - 4x^3)$$

$$\delta_C = \delta_{\max} = \frac{5qL^4}{384EI} \quad \theta_A = \theta_B = \frac{qL^3}{24EI}$$

# Giros

Considerando un momento unitario aplicado en A:

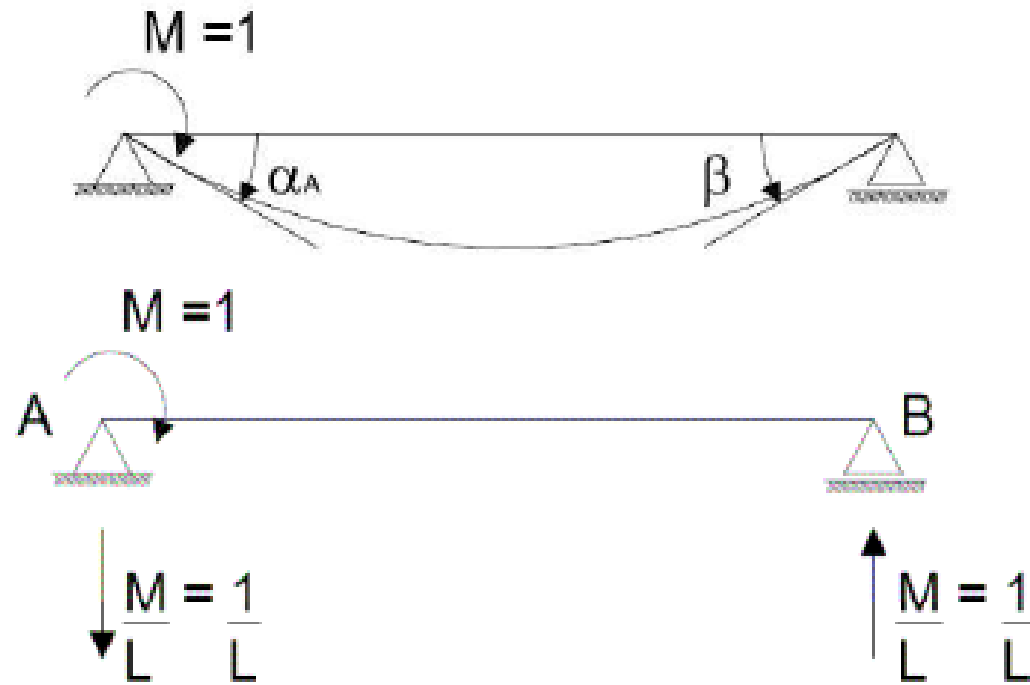

# Giros (cont.)

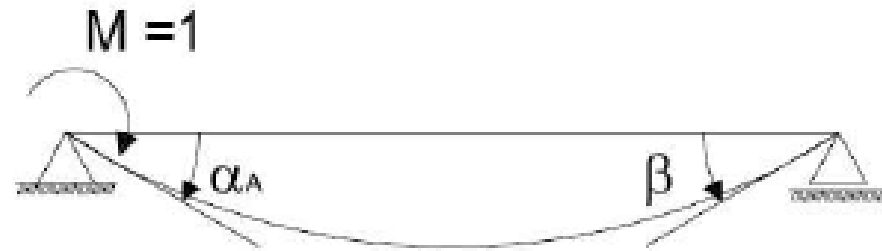

$$M(z) = 1 - \frac{z}{L} = \frac{L - z}{L}$$

$$\alpha_A = \frac{1}{L} \int_0^L \frac{\left(1 - \frac{z}{L}\right)(L - z)}{EI_x} dz$$

$$\beta = \frac{1}{L} \int_0^L \frac{\left(1 - \frac{z}{L}\right)}{EI_x} z dz$$

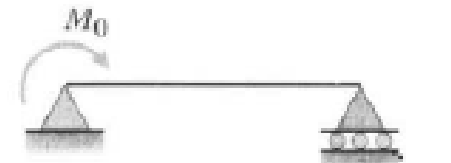

$$\theta_A = \frac{M_0 L}{3EI} \quad \theta_B = \frac{M_0 L}{6EI}$$

# Giros (cont.)

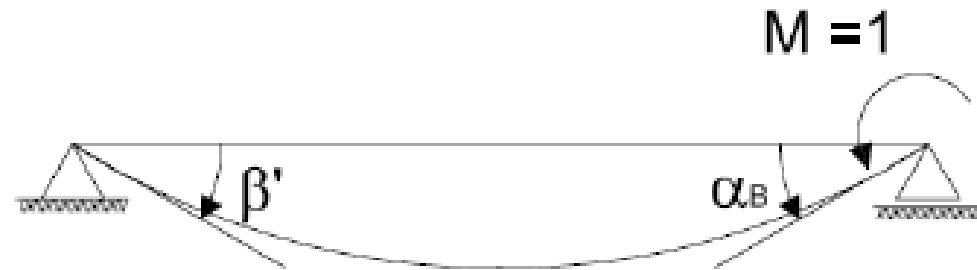

# Giros (cont \)

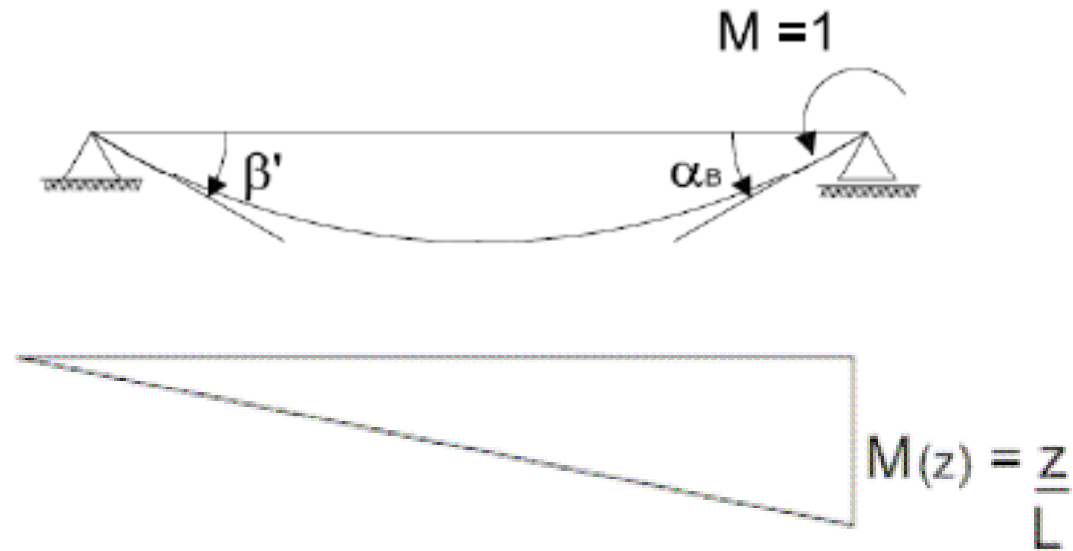

$$\alpha_B = \frac{1}{L} \int_0^L \frac{z}{L} \times \frac{z}{EI_x} dz$$
$$\beta' = \frac{1}{L} \int_0^L \frac{\frac{z}{L} (L-z)}{EI_x} dz = \beta$$

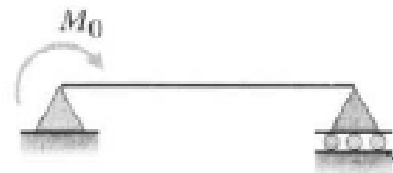

$$\theta_A = \frac{M_0 L}{3EI} \quad \theta_B = \frac{M_0 L}{6EI} \quad \text{Con } EI \text{ cte.}$$

# Descenso de apoyos

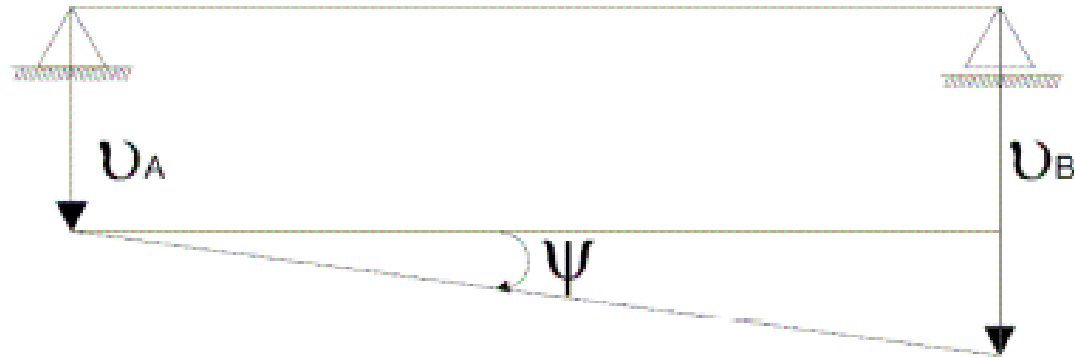

$$v_A = v(0)$$

$$v_B = v(L)$$

$$\psi \equiv \operatorname{tg} \psi = \frac{v_B - v_A}{L}$$

$$\theta_A = \psi$$

$$\theta_B = -\psi$$

Vigas Rectas continuas



# Caso General (El cualquiera)

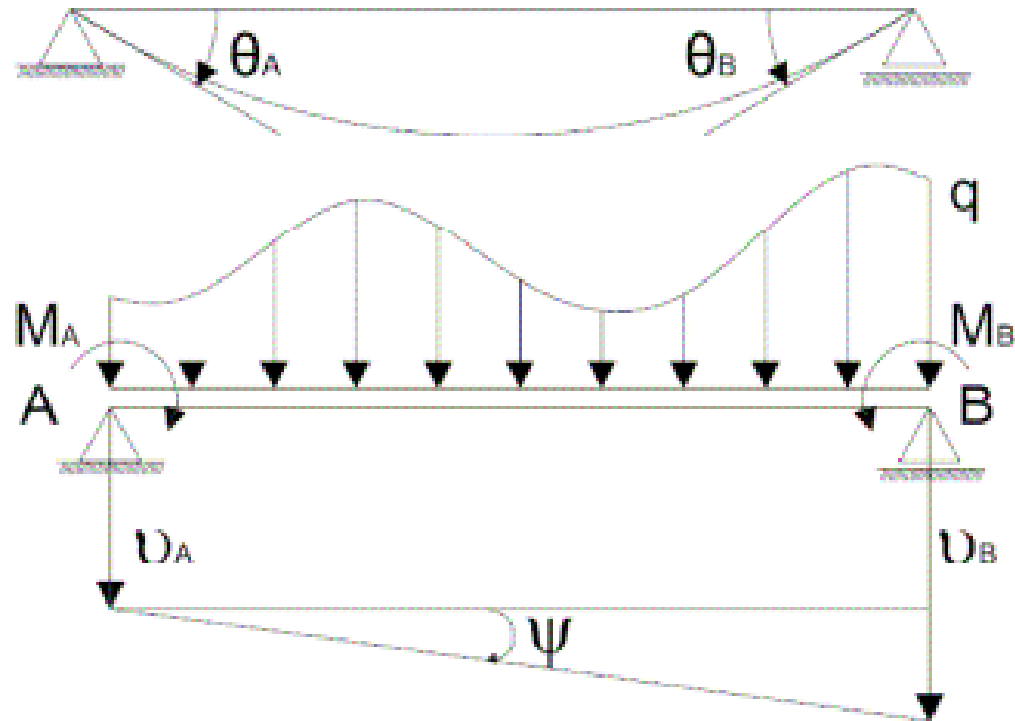

$$\theta_A = \alpha_{0A} + M_A \cdot \alpha_A + M_B \cdot \beta + \psi$$

$$\theta_B = \alpha_{0B} + M_A \cdot \beta + M_B \cdot \alpha_B - \psi$$

# Caso EI constante

$$\alpha_A = \frac{L}{EI_x} \int_0^1 (1 - 2 \cdot u + u^2) du = \frac{L}{EI_x} \left( u - u^2 + \frac{u^3}{3} \right) \Big|_0^1 \Rightarrow \alpha_A = \frac{L}{3EI_x}$$

$$\alpha_B = \frac{L}{EI_x} \int_0^1 u^2 du = \frac{L}{EI_x} \left( \frac{u^3}{3} \right) \Big|_0^1 \Rightarrow \alpha_B = \frac{L}{3EI_x}$$

$$\beta = \frac{L}{EI_x} \int_0^1 (1 - u) u du = \frac{L}{EI_x} \left( \frac{u^2}{2} - \frac{u^3}{3} \right) \Big|_0^1 = \frac{L}{EI_x} \left( \frac{1}{2} - \frac{1}{3} \right) \Rightarrow \beta = \frac{L}{6EI_x}$$

$$\alpha = \alpha_A = \alpha_B = \frac{L}{3EI_x}$$

$$\beta = \frac{L}{6EI_x} = \frac{1}{2} \alpha$$

$$\alpha_A = \frac{1}{L} \int_0^L \frac{\left(1 - \frac{z}{L}\right)(L - z)}{EI_x} dz$$

$$\beta = \frac{1}{L} \int_0^L \frac{\left(1 - \frac{z}{L}\right)}{EI_x} z dz$$

$$\alpha_B = \frac{1}{L} \int_0^L \frac{z}{L} \times \frac{z}{EI_x} dz$$

$$\beta = \frac{1}{L} \int_0^L \frac{\frac{z}{L}(L - z)}{EI_x} dz = \beta$$

# Viga continua de $N$ tramos

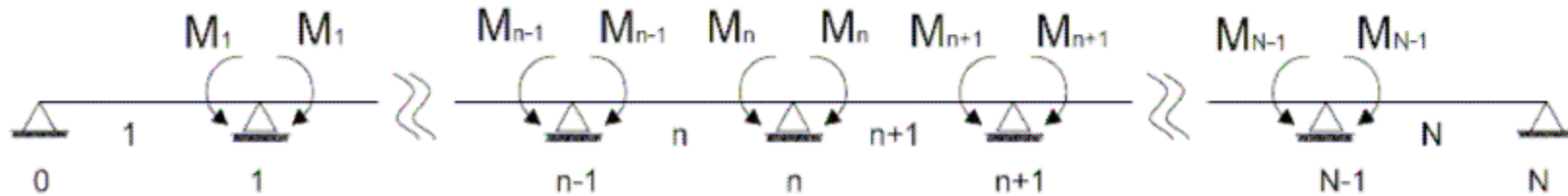

En un apoyo genérico  $n$

- confluyen los tramos  $n$  y  $n+1$
- hay transmisión de momento,
- no hay transmisión de cortante (ya que cada tramo descarga de forma independiente en el apoyo).

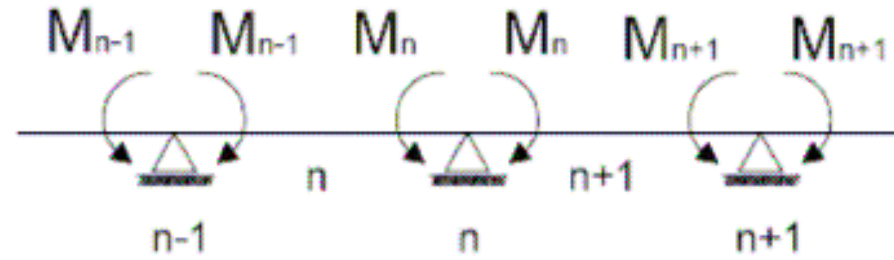

$\theta_{n-1}^n$  Barra n En el caso anterior era  $\theta_A$   
 Nudo n-1

$\theta_n^n$  Barra n En el caso anterior era  $\theta_B$   
 Nudo n

$M_n$  Depende solo del nudo n

$\psi^n$  Depende solo de la barra

# Ecuaciones angulares

$\theta_{n-1}^n$  Barra n  
Nudo n-1

Análoga situación se presenta para el coeficiente  $\beta$  donde para el tramo n es  $\beta^n$ . Los términos  $\alpha_{0A}$  y  $\alpha_{0B}$  de la barra n se denominan  $\alpha_{0_{n-1}}^n$  y  $\alpha_{0_n}^n$ . Los coeficientes  $\alpha_A$  y  $\alpha_B$  de la barra n se llaman  $\alpha_{n-1}^n$  y  $\alpha_n^n$ . En el caso que la sección de la viga sea constante estos coeficientes dependen solo del tramo y se denomina a ambos  $\alpha^n$ .

$$\theta_{n-1}^n = \alpha_{0_{n-1}}^n + M_{n-1} \alpha_{n-1}^n + M_n \beta^n + \psi^n$$

$$\theta_n^n = \alpha_{0_n}^n + M_{n-1} \beta^n + M_n \alpha_n^n - \psi^n$$

$$\theta_n^{n+1} = \alpha_{0_n}^{n+1} + M_n \alpha_n^{n+1} + M_{n+1} \beta^{n+1} + \psi^{n+1}$$

$$\theta_{n+1}^{n+1} = \alpha_{0_{n+1}}^{n+1} + M_n \beta^{n+1} + M_{n+1} \alpha_{n+1}^{n+1} - \psi^{n+1}$$

Donde sabemos que:

$$\psi^n = \frac{v_n - v_{n-1}}{L^n}$$

# Ecuación de tres momentos

$\theta_{n-1}^n$  Barra n  
 Nudo n-1

$$\theta_n^n = -\theta_n^{n+1}$$

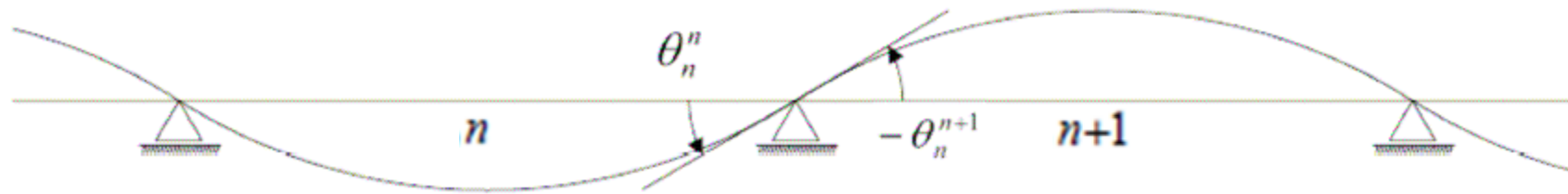

$$\theta_n^n + \theta_n^{n+1} = 0$$

$$\theta_n^n = \alpha_{0n}^n + M_{n-1}\beta^n + M_n\alpha_n^n - \psi^n$$

$$\theta_n^{n+1} = \alpha_{0n}^{n+1} + M_n\alpha_n^{n+1} + M_{n+1}\beta^{n+1} + \psi^{n+1}$$

$$M_{n-1}\beta^n + M_n(\alpha_n^n + \alpha_n^{n+1}) + M_{n+1}\beta^{n+1} + \alpha_{0n}^n + \alpha_{0n}^{n+1} - \psi^n + \psi^{n+1} = 0$$

# Ecuación de tres momentos

$\theta_{n-1}^n$  Barra n  
Nudo n-1

$$M_{n-1}\beta^n + M_n(\alpha_n^n + \alpha_n^{n+1}) + M_{n+1}\beta^{n+1} + \alpha_{0n}^n + \alpha_{0n}^{n+1} - \psi^n + \psi^{n+1} = 0$$

$$\alpha_{0n}^n \text{ y } \alpha_{0n}^{n+1}$$

Dependen de la geometría de la estructura y de las cargas aplicadas

$$\psi^n \text{ y } \psi^{n+1}$$

Dependen de los descensos de los apoyos y de la geometría de la estructura

$$\alpha_n^n, \alpha_n^{n+1}, \beta^n \text{ y } \beta^{n+1}$$

Dependen de la geometría y de los Momentos:

$$M_{n-1}, M_n \text{ y } M_{n+1}$$

# Viga Continua

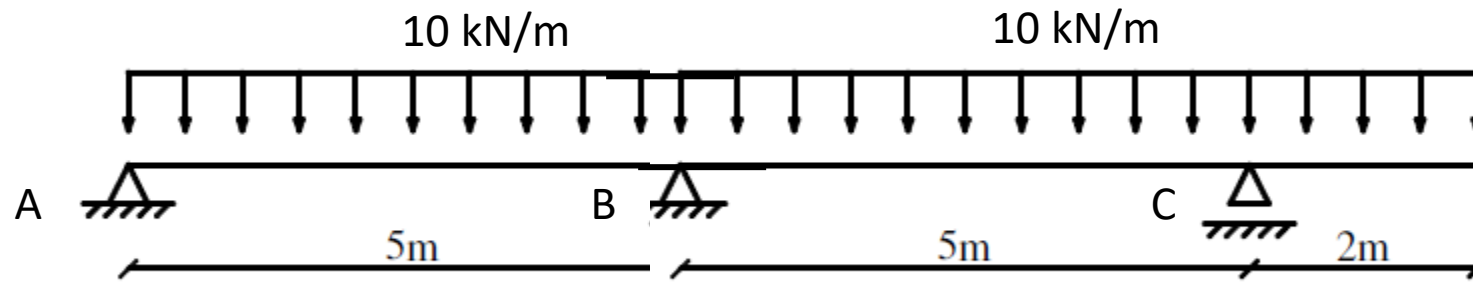

$$M_{n-1}\beta^n + M_n(\alpha_n^n + \alpha_n^{n+1}) + M_{n+1}\beta^{n+1} + \alpha_{0n}^n + \alpha_{0n}^{n+1} - \psi^n + \psi^{n+1} = 0$$



# Viga Continua

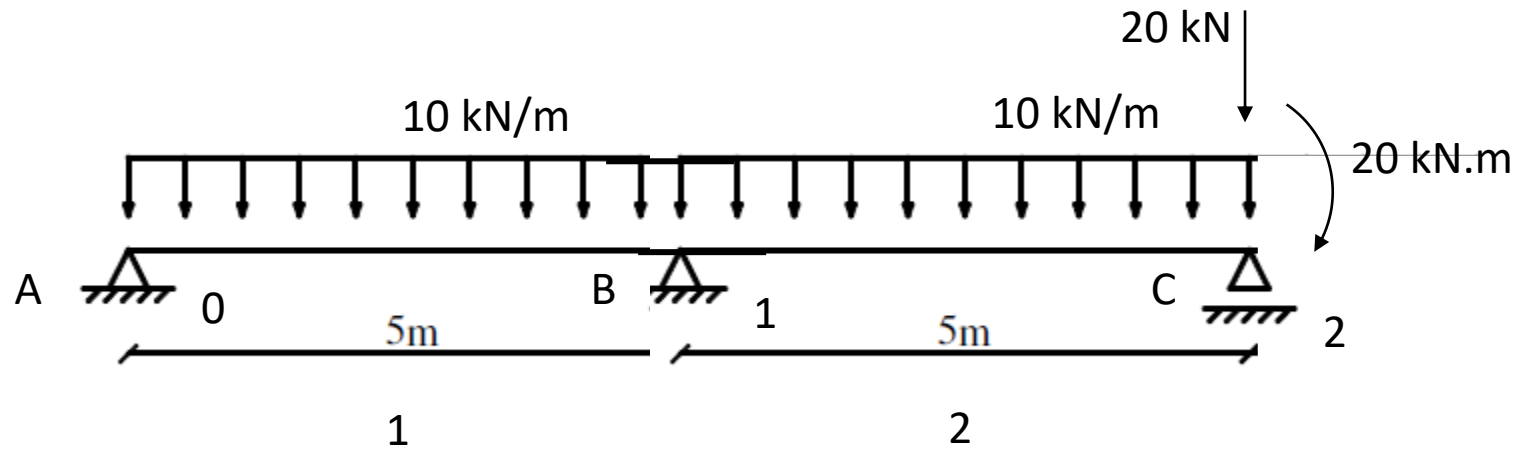

$$M_{n-1}\beta^n + M_n(\alpha_n^n + \alpha_n^{n+1}) + M_{n+1}\beta^{n+1} + \alpha_{0n}^n + \alpha_{0n}^{n+1} - \psi^n + \psi^{n+1} = 0$$

?
?
?
?

# Viga Continua

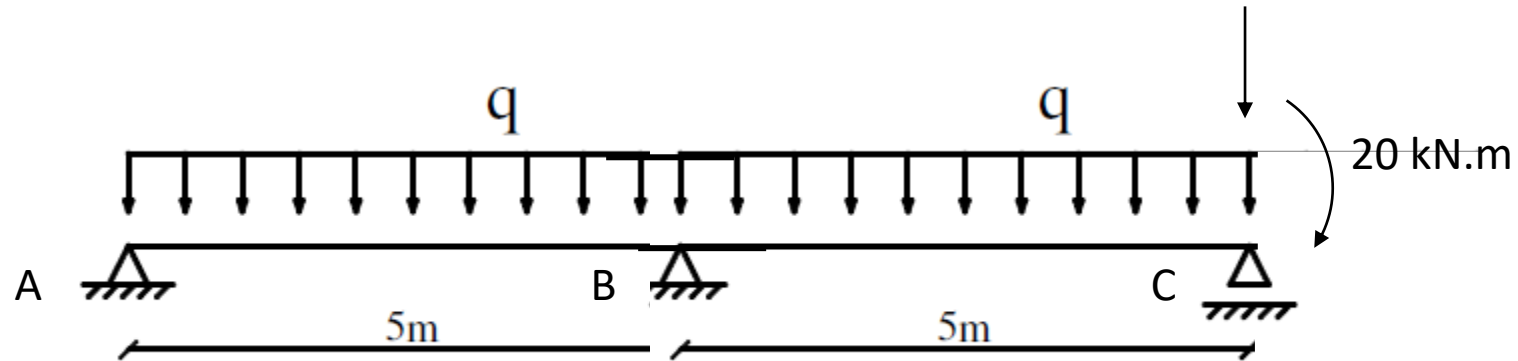

$$M_{n-1}\beta^n + M_n(\alpha_n^n + \alpha_n^{n+1}) + M_{n+1}\beta^{n+1} + \alpha_{0_n}^n + \alpha_{0_n}^{n+1} - \psi^n + \psi^{n+1} = 0$$

$$0. \beta^n + M_B (\alpha_n^n + \alpha_n^{n+1}) + -20. \beta^{n+1} + \alpha_{0_n}^n + \alpha_{0_n}^{n+1} - 0 + 0 = 0$$

$L_{AB}/3EI$

$L_{BC}/3EI$

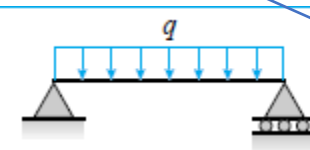

$$v = -\frac{qx}{24EI}(L^3 - 2Lx^2 + x^3)$$

$$v' = -\frac{q}{24EI}(L^3 - 6Lx^2 - 4x^3)$$

$$\delta_C = \delta_{\max} = \frac{5qL^4}{384EI} \quad \theta_A = \theta_B = \frac{qL^3}{24EI}$$

# Ejemplo Cont.

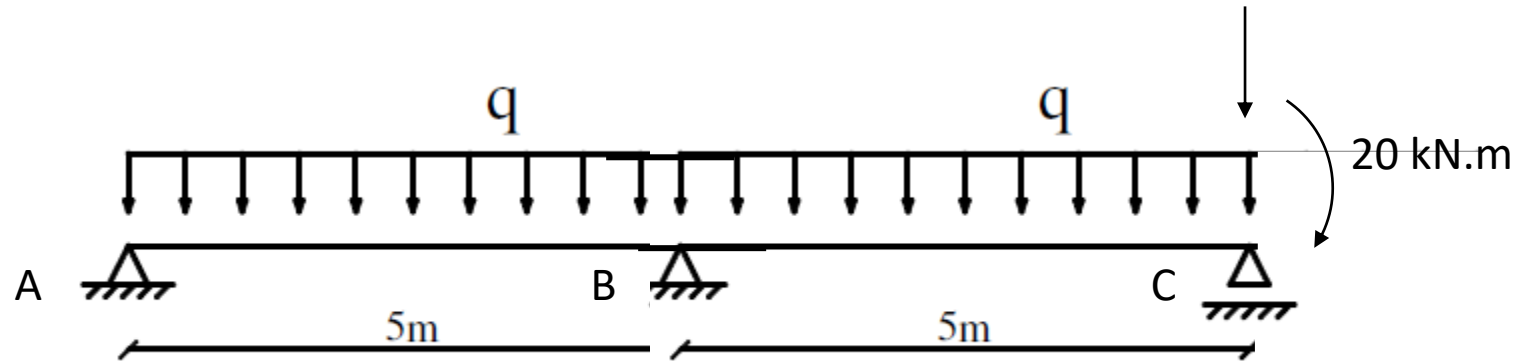

$$0. \beta^n + M_B (\alpha_n^n + \alpha_n^{n+1}) + \dots - 20. \beta^{n+1} + \alpha_{0n}^n + \alpha_{0n}^{n+1} - 0 + 0 = 0$$

$$M_B \cdot (L_{AB}/3EI + L_{BC}/3EI) - 20 \cdot L_{BC}/6EI + L_{AB}^3 \cdot q/24EI + L_{BC}^3 \cdot q/24EI = 0$$

$$M_B = -420/16 = -26.3 \text{ kN.m}$$

# Ejemplo Cont.

$$M_B = -420/16 = -26.3 \text{ kN.m}$$

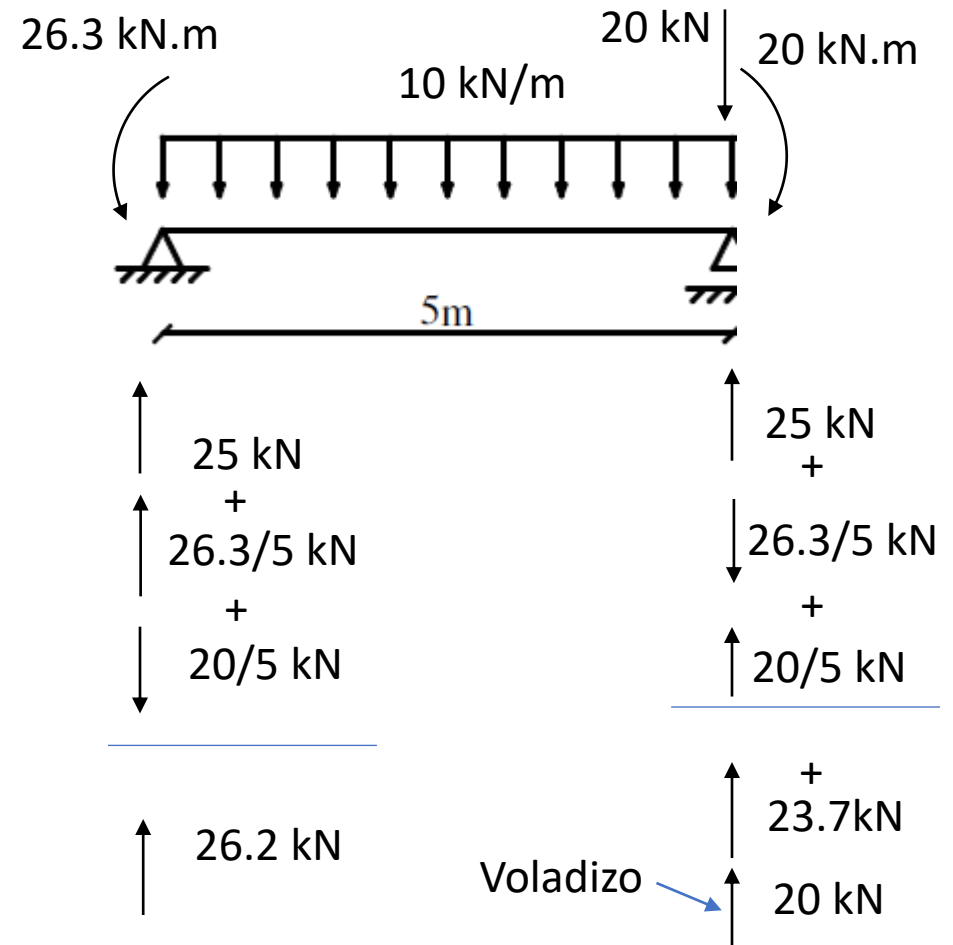
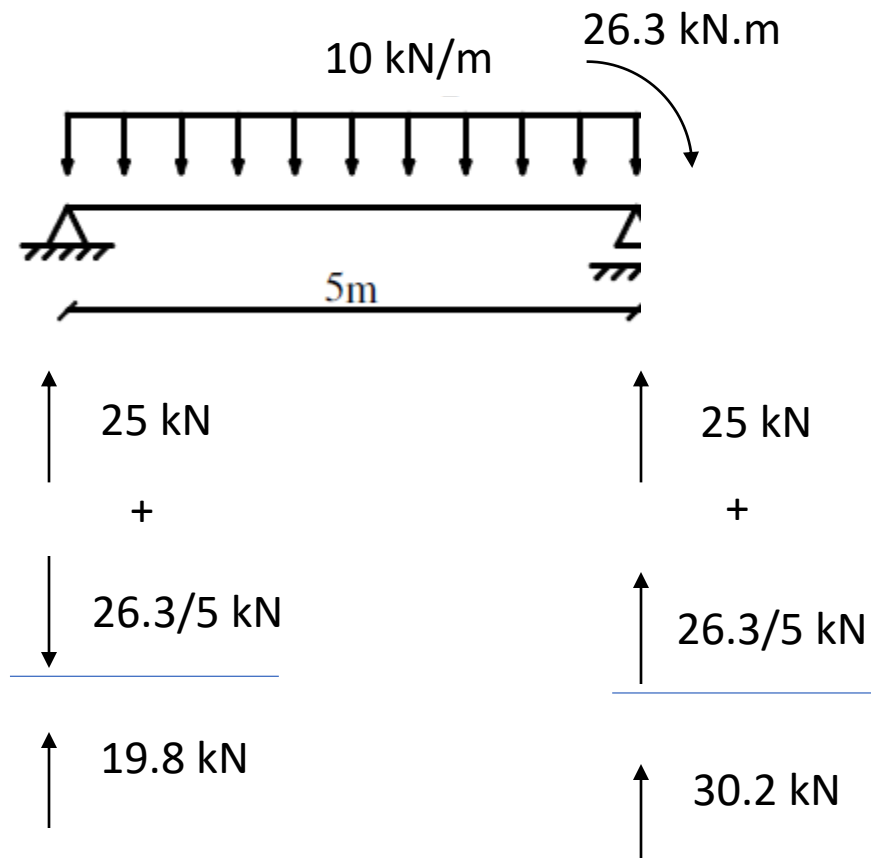

# Diagramas

V(kN)

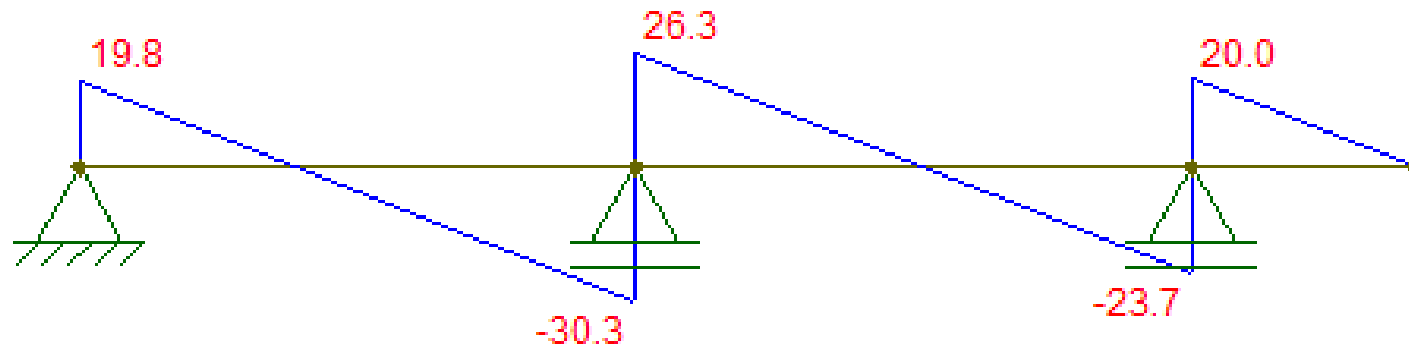

M(kN.m)

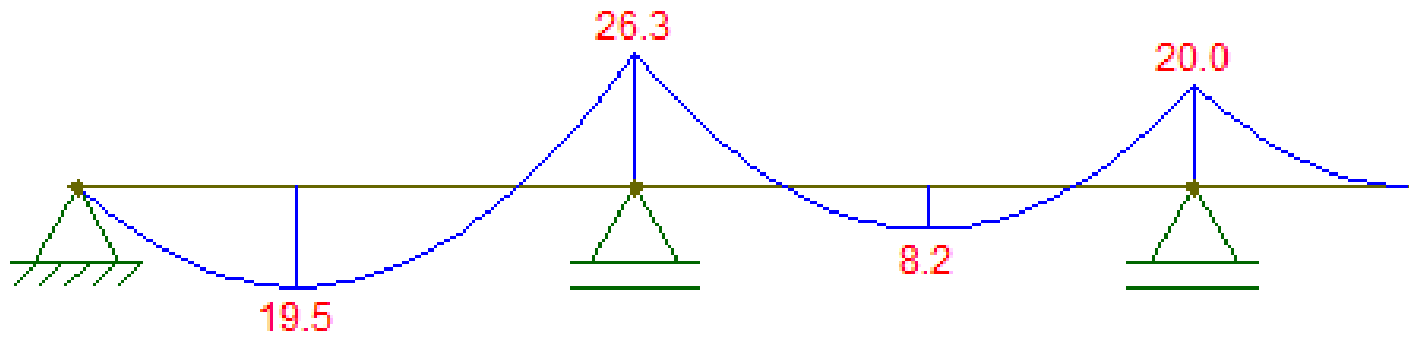

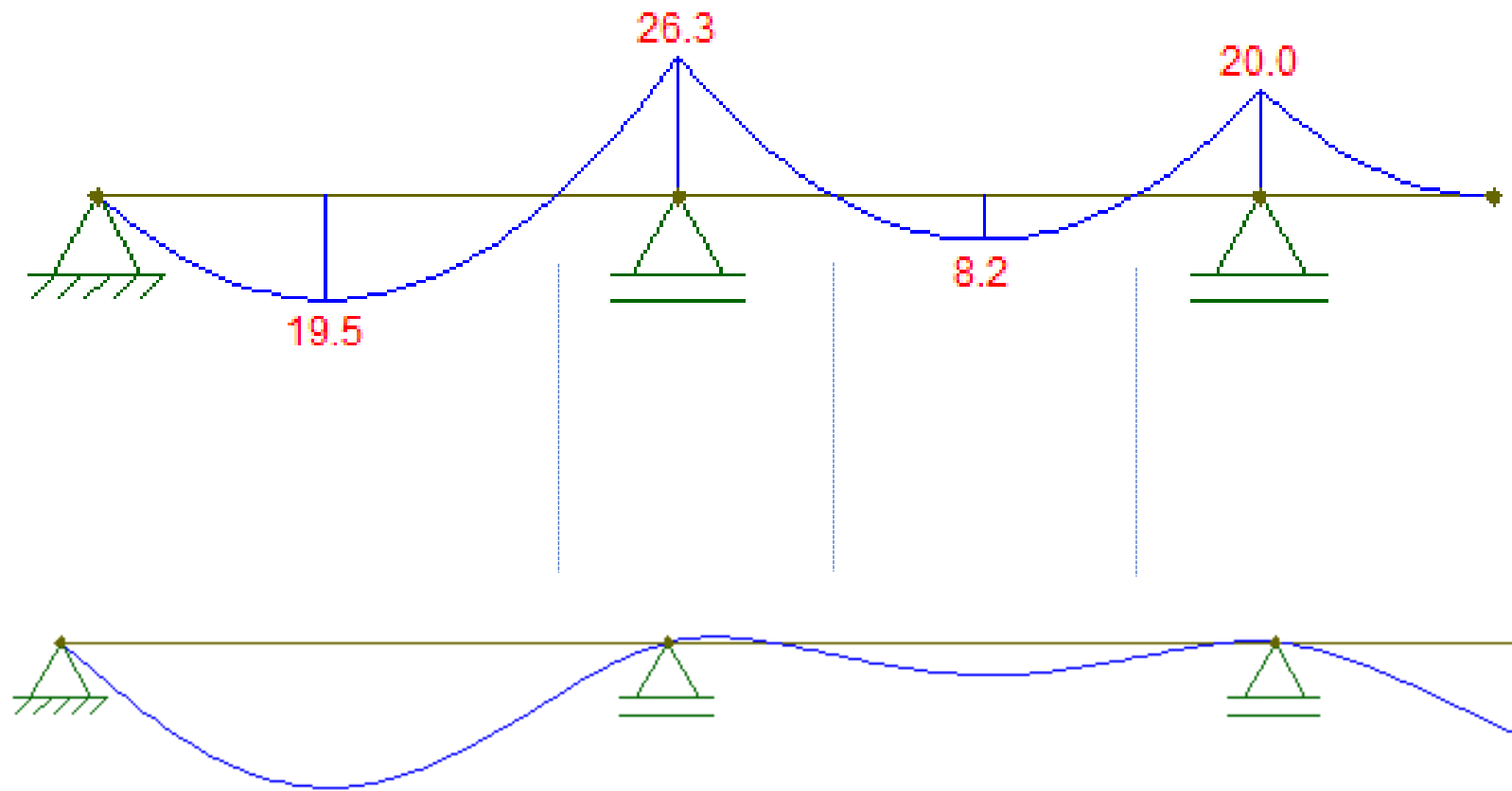

# Ecuación de 3 y 5 Momentos

## Ejemplos

# Reacciones

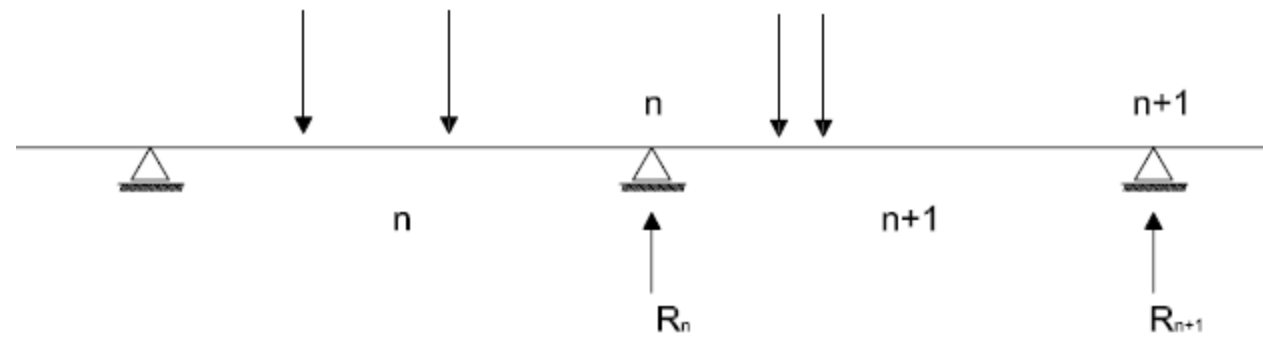

$$R_n = R_n^n + R_n^{n+1}$$

$$R_n^n = R_{0n}^n + \frac{M_{n-1}}{L^n} - \frac{M_n}{L^n}$$

$$R_n^{n+1} = R_{0n}^{n+1} - \frac{M_n}{L^{n+1}} + \frac{M_{n+1}}{L^{n+1}}$$



# Reacciones

$$R_n = R_{0n}^n + R_{0n}^{n+1} + \frac{M_{n-1}}{L^n} - \frac{M_n}{L^n} - \frac{M_n}{L^{n+1}} + \frac{M_{n+1}}{L^{n+1}}$$

$$R_{0n} + \frac{1}{L^n} (M_{n-1} - M_n) + \frac{1}{L^{n+1}} (M_{n+1} - M_n)$$

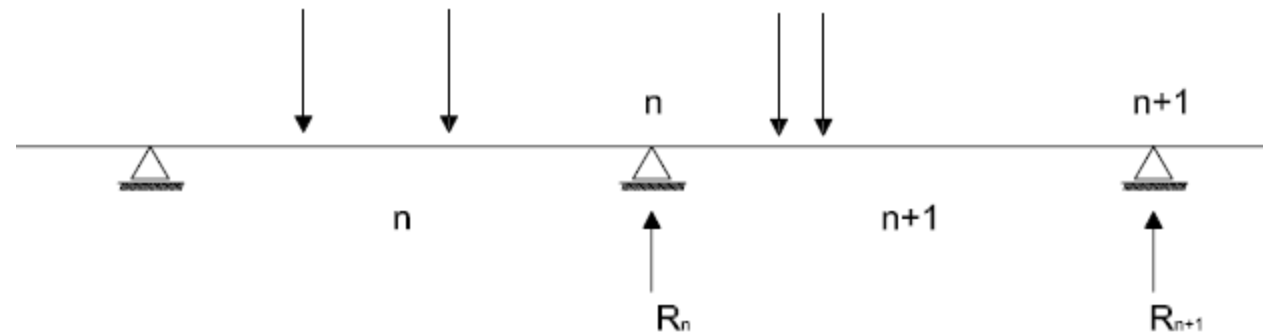

N+1 apoyos, N tramos

$$M_{n-1}\beta^n + M_n(\alpha_n^n + \alpha_n^{n+1}) + M_{n+1}\beta^{n+1} + \alpha_{0n}^n + \alpha_{0n}^{n+1} - \psi^n + \psi^{n+1} = 0$$

Tenemos n-1 momentos M como incognita.

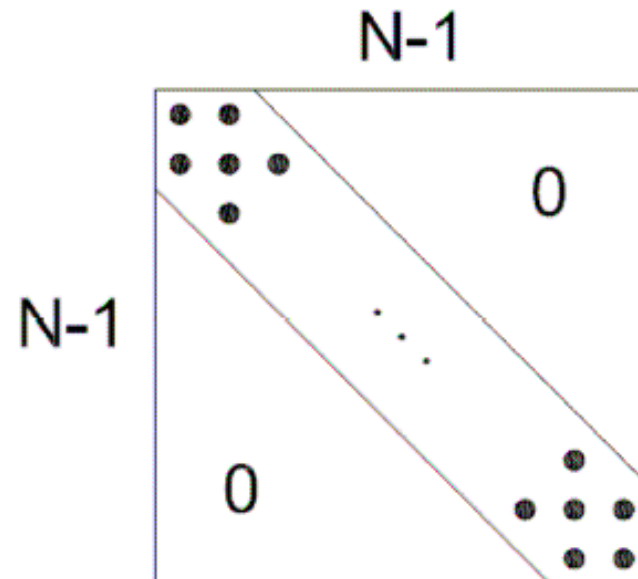

# Viga continua con empotramientos

 $\theta_0^1$ 

Barra 1

Nudo 0

Empotramiento en el primer apoyo:

$$\theta_0^1 = 0 = \alpha_{00}^1 + M_0 \alpha_0^1 + M_1 \beta^1 + \psi^1$$

Tenemos una incognita más que sería  $M_0$  y  $n$  ecuaciones

$$M_{n-1} \beta^n + M_n (\alpha_n^n + \alpha_n^{n+1}) + M_{n+1} \beta^{n+1} + \alpha_{0n}^n + \alpha_{0n}^{n+1} - \psi^n + \psi^{n+1} = 0$$

Si  $n=0$ , entonces no tienen sentido los subindices (apoyos) negativos, ni los tramos igual a cero (superindices).

# Viga continua con empotramientos

Empotramiento en el apoyo n:

$$\theta_N^N = 0 = \alpha_{0N}^N + M_{N-1}\beta^N + M_N\alpha_N^N - \psi^N$$

Tenemos una incognita más que sería  $M_n$  y n ecuaciones

$$M_{n-1}\beta^n + M_n(\alpha_n^n + \alpha_n^{n+1}) + M_{n+1}\beta^{n+1} + \alpha_{0n}^n + \alpha_{0n}^{n+1} - \psi^n + \psi^{n+1} = 0$$

# Vigas con EI cte

$$\beta^n = \frac{L^n}{6EI_x}$$

$$\alpha^n = \alpha_n^n = \alpha_{n-1}^n = \frac{L^n}{3EI_x}$$

Sustituyendo en la Ec. de 3 Momentos y multiplicando por 6 EI:

$$M_{n-1}L^n + 2M_n(L^n + L^{n+1}) + M_{n+1}L^{n+1} + 6EI_x(\alpha_{0n}^n + \alpha_{0n}^{n+1}) + 6EI_x(\psi^{n+1} - \psi^n) = 0$$

$$\alpha_{0n}^n = \frac{1}{L^n} \int_0^{L^n} \frac{M}{EI_x} z dz$$

$$6EI_x \alpha_{0n}^n = \frac{6}{L^n} \int_0^{L^n} Mz dz$$

$$\alpha_{0n}^{n+1} = \frac{1}{L^{n+1}} \int_0^{L^{n+1}} \frac{M}{EI_x} (L^{n+1} - z) dz$$

$$6EI_x \alpha_{0n}^{n+1} = \frac{6}{L^{n+1}} \int_0^{L^{n+1}} M(L^{n+1} - z) dz$$

# Términos de Carga

$$M_{n-1}L^n + 2M_n(L^n + L^{n+1}) + M_{n+1}L^{n+1} + 6EI_x(\alpha_{0n}^n + \alpha_{0n}^{n+1}) + 6EI_x(\psi^{n+1} - \psi^n) = 0$$

$$6EI_x\alpha_{0n}^n = \frac{6}{L^n} \int_0^{L^n} Mz dz \quad \mathcal{R}^n = \frac{6}{(L^n)^2} \int_0^{L^n} Mz dz \quad \mathcal{L}^n = \frac{6}{(L^n)^2} \int_0^{L^n} M(L^n - z) dz$$

$$6EI_x\alpha_{0n}^{n+1} = \frac{6}{L^{n+1}} \int_0^{L^{n+1}} M(L^{n+1} - z) dz \quad \mathcal{L}^{n+1} = \frac{6}{(L^{n+1})^2} \int_0^{L^{n+1}} M(L^{n+1} - z) dz$$

$$M_{n-1}L^n + 2M_n(L^n + L^{n+1}) + M_{n+1}L^{n+1} + \mathcal{R}^n L^n + \mathcal{L}^{n+1} L^{n+1} + 6EI_x(\psi^{n+1} - \psi^n) = 0$$

# Términos de Carga



Instituto de Estructuras y Transporte  
Prof. Julio Ricaldoni

## TÉRMINOS DE CARGA

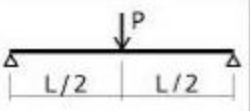
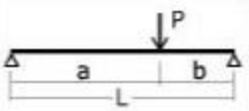
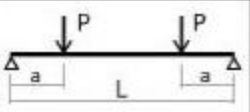
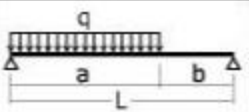
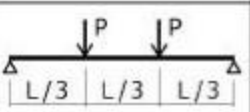
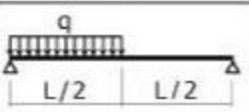
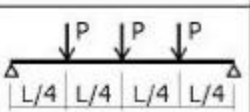
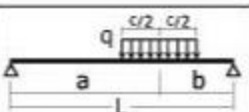
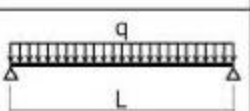
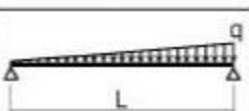
CARGAS SIMÉTRICAS		CARGAS NO SIMÉTRICAS		
ESTADO DE CARGA	$\mathcal{L} = \mathcal{R}$	ESTADO DE CARGA	$\mathcal{L}$	$\mathcal{R}$
	$\frac{3}{8} PL$		$\frac{Qab}{L^2} (L+b)$	$\frac{Qab}{L^2} (L+a)$
	$3Pa(1-\frac{a}{L})$		$\frac{qa^2}{4} (2-\frac{a}{L})^2$	$\frac{qa^2}{4} (2-\frac{a^2}{L^2})$
	$\frac{2}{3} PL$		$\frac{9}{64} qL^2$	$\frac{7}{64} qL^2$
	$\frac{15}{16} PL$		$\frac{qabc}{L^2} (L+b-\frac{c^2}{4a})$	$\frac{qabc}{L^2} (L+a-\frac{c^2}{4b})$
	$\frac{1}{4} qL^2$		$\frac{7}{60} qL^2$	$\frac{2}{15} qL^2$

# Viga sobre apoyos elásticos

$$R_n = k_n \cdot v_n$$

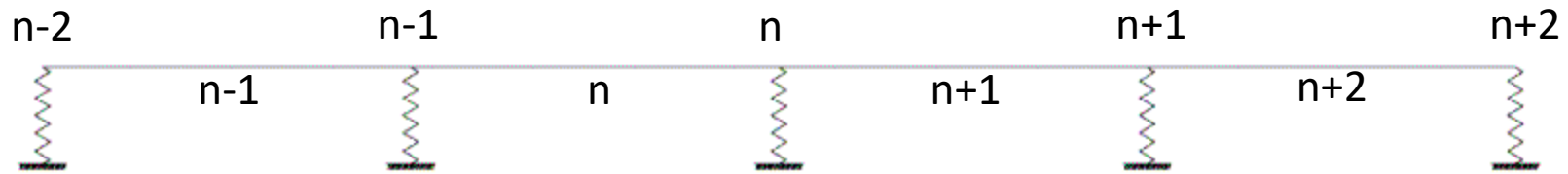



# Descenso de apoyos

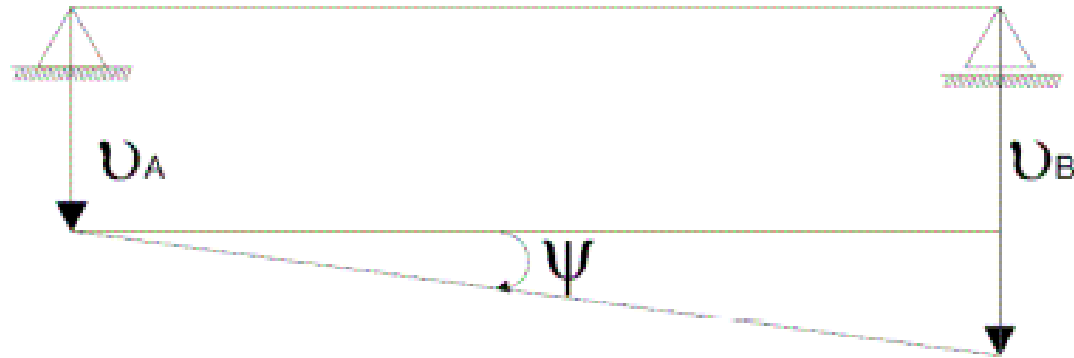

$$v_A = v(0)$$

$$v_B = v(L)$$

$$\psi \cong \operatorname{tg} \psi = \frac{v_B - v_A}{L}$$

$$\theta_A = \psi$$

$$\theta_B = -\psi$$

# Apoyos elásticos

$$R_n = k_n \cdot v_n$$

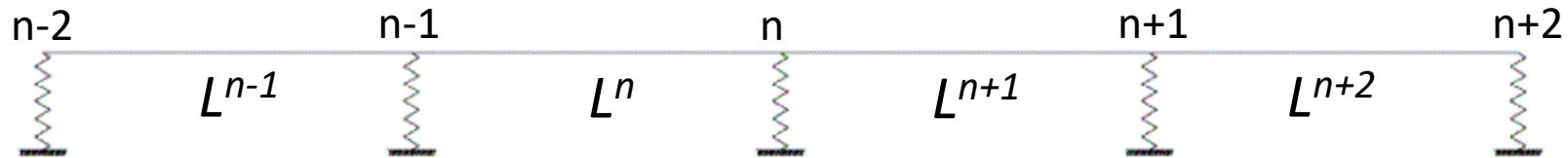

$$\psi^n = \frac{v_n - v_{n-1}}{L^n}$$

$$\psi^{n+1} = \frac{v_{n+1} - v_n}{L^{n+1}}$$

$$\psi^n = \frac{\frac{R_n}{k_n} - \frac{R_{n-1}}{k_{n-1}}}{L^n} =$$

# Viga sobre apoyos elásticos

$$\psi^n = f_1(M_{n-2}, M_{n-1}, M_n, M_{n+1}, R_{0n}, R_{0n-1})$$

$$\psi^{n+1} = f_2(M_{n-1}, M_n, M_{n+1}, M_{n+2}, R_{0n}, R_{0n+1})$$

siendo ambas ecuaciones lineales.

Sustituyendo en la ecuación de tres momentos,

$$M_{n-1}\beta^n + M_n(\alpha_n^n + \alpha_n^{n+1}) + M_{n+1}\beta^{n+1} + \alpha_{0n}^n + \alpha_{0n}^{n+1} - \psi^n + \psi^{n+1} = 0$$

# Ecuación de 5 Momentos

Sustituyendo en la Ec. de 3 M

$$A \cdot M_{n-2} + B \cdot M_{n-1} + C \cdot M_n + D \cdot M_{n+1} + E \cdot M_{n+2} + F \cdot R_{0,n-1} + G \cdot R_{0,n} + H \cdot R_{0,n+1} + \alpha_{0n}^n + \alpha_{0n}^{n+1} = 0$$

$$A = \frac{1}{k_{n-1} L^{n-1} L^n}$$

$$B = \beta^n - \frac{1}{k_n (L^n)^2} - \frac{1}{k_{n-1} L^{n-1} L^n} - \frac{1}{k_{n-1} (L^n)^2} - \frac{1}{k_n L^n L^{n+1}}$$

$$C = \alpha_n^n + \alpha_n^{n+1} + \frac{1}{k_n (L^n)^2} + \frac{2}{k_n L^n L^{n+1}} + \frac{1}{k_{n-1} (L^n)^2} + \frac{1}{k_{n+1} (L^{n+1})^2} + \frac{1}{k_n (L^{n+1})^2}$$

$$D = \beta^{n+1} - \frac{1}{k_n L^n L^{n+1}} - \frac{1}{k_{n+1} (L^{n+1})^2} - \frac{1}{k_{n+1} L^{n+1} L^{n+2}} - \frac{1}{k_n (L^{n+1})^2}$$

$$E = \frac{1}{k_{n+1} L^{n+1} L^{n+2}}$$

$$F = \frac{1}{k_{n-1} L^n}$$

$$G = -\frac{1}{k_n L^n} - \frac{1}{k_n L^{n+1}}$$

$$H = \frac{1}{k_{n+1} L^{n+1}}$$

# Apoyo

Si un apoyo es fijo (no es elástico)  $k_n = \infty$

$$R_{n-1} = R_0 = R_{00} + \frac{M_1}{L^1} \quad n=1$$

$$R_n = R_1 = R_{0,1} - \frac{M_1}{L^1} - \frac{M_1}{L^2} + \frac{M_2}{L^2}$$

no existe el tramo 0, ni el momento  $M_0$ , ni tampoco el apoyo -1

# Ejemplo

PNI20 material es acero ( $E=2.1 \times 10^{11} \text{ N/m}^2$ )

- Hallar reacciones y trazar diagramas de sollicitaciones

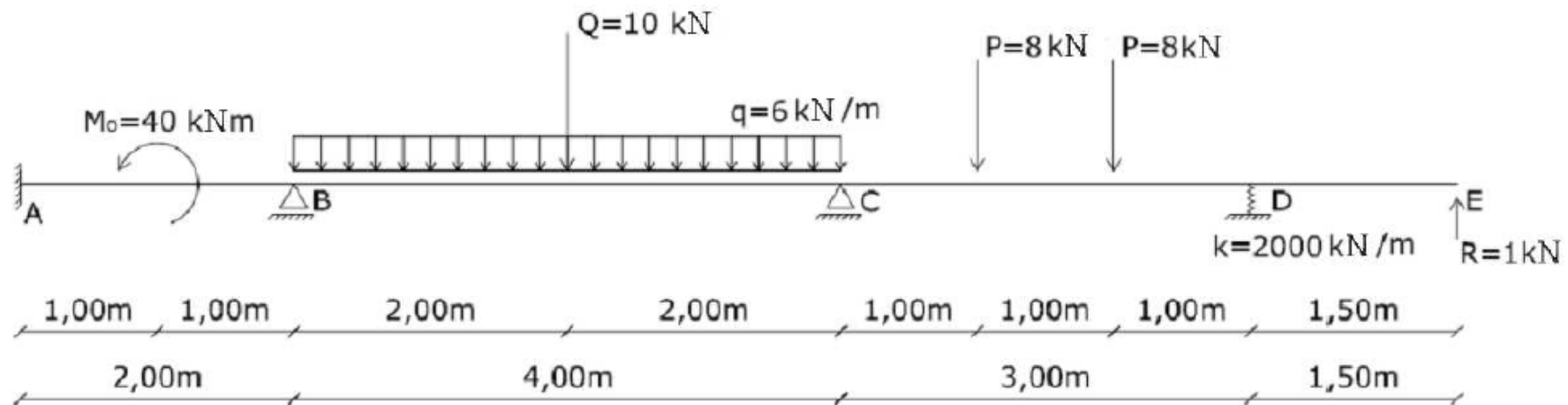

emplo

PNI20 material es acero ( $E=2.1 \times 10^{11} \text{ N/m}^2$ )

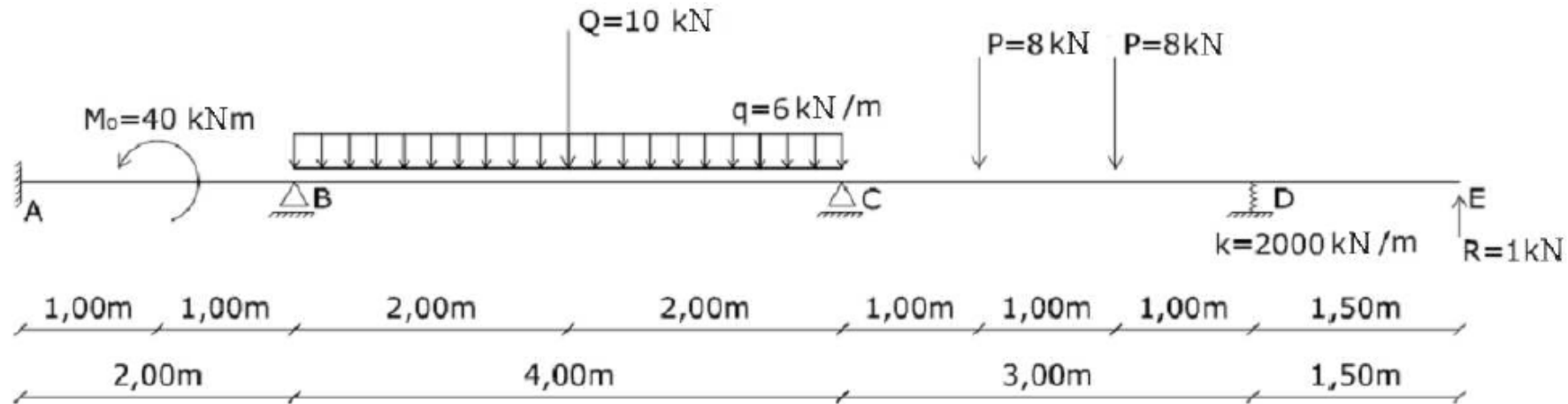

$$\theta_A = 0$$

Utilizando la ecuación:

$$\alpha_{0A}^1 + \alpha_A^1 \cdot M_A + \beta^1 \cdot M_B + \psi = 0$$

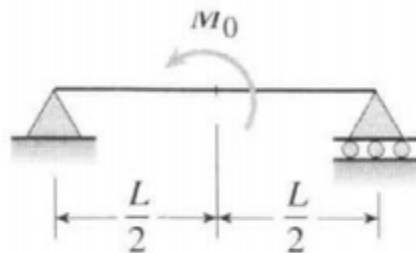
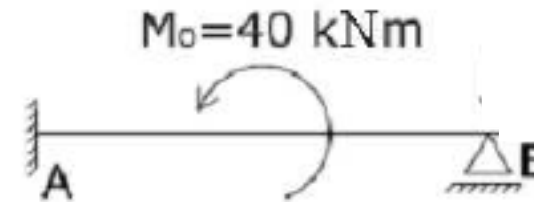

$$v = -\frac{M_0 x}{24EI} (L^2 - 4x^2)$$

$$\delta_C = 0 \quad \theta_A = \frac{M_0 L}{24EI}$$

$$\alpha_{0A}^1 = \frac{M_0 L}{24 \cdot EI} = \frac{40000 \times 2}{24 \cdot EI}$$

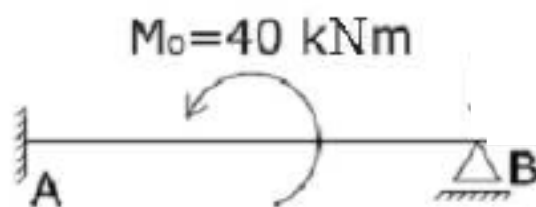
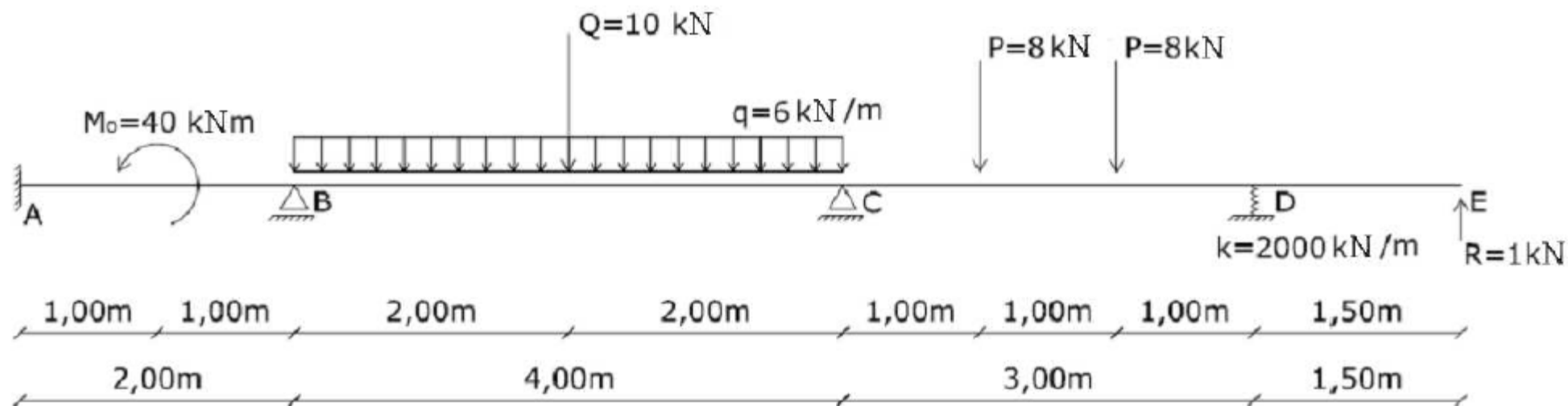

$$\theta_A = 0$$

Utilizando la ecuación:

$$\alpha_{0A}^1 + \alpha_A^1 \cdot M_A + \beta^1 \cdot M_B + \psi = 0$$

$$\alpha_A^1 = \frac{L}{3 \cdot EI} = \frac{2}{3 \cdot EI}$$

$$\beta^1 = \frac{L}{6 \cdot EI} = \frac{2}{6 \cdot EI}$$



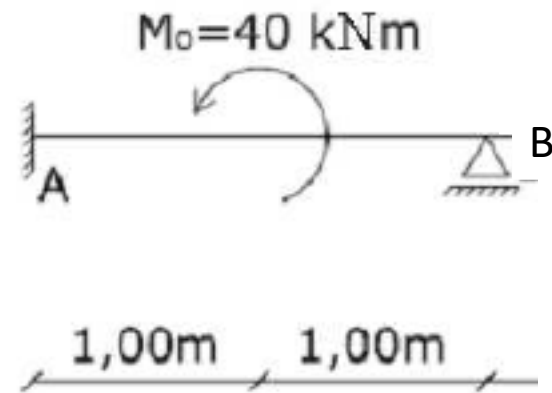

$$\theta_A = 0$$

Utilizando la ecuación:

$$\alpha_{0A}^1 + \alpha_A^1 \cdot M_A + \beta^1 \cdot M_B + \psi = 0$$

$$\alpha_{0A}^1 = \frac{M_0 L}{24 \cdot EI} = \frac{40000 \times 2}{24 \cdot EI}$$

$$\alpha_A^1 = \frac{L}{3 \cdot EI} = \frac{2}{3 \cdot EI}$$

$$\beta^1 = \frac{L}{6 \cdot EI} = \frac{2}{6 \cdot EI}$$

$$\frac{40000 \times 2}{24 \cdot EI} + \frac{2}{3 \cdot EI} \cdot M_A + \frac{2}{6 \cdot EI} \cdot M_B = 0$$

$$2 \cdot M_A + M_B = -10000 \text{ Nm}$$

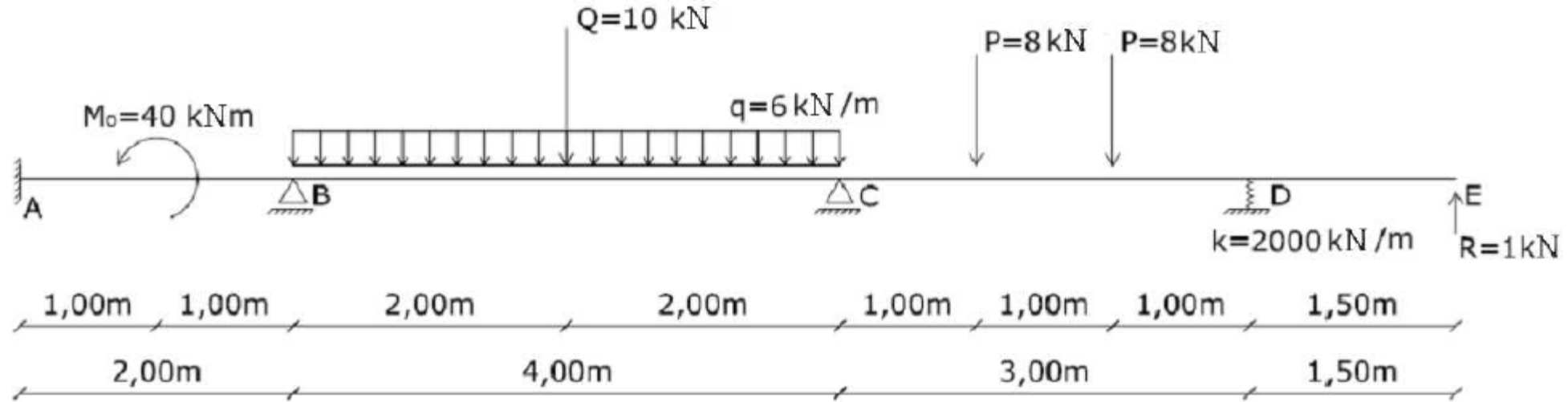

Aplicamos 3 Momentos en el apoyo B

$$M_{n-1}\beta^n + M_n(\alpha_n^n + \alpha_n^{n+1}) + M_{n+1}\beta^{n+1} + \alpha_{0n}^n + \alpha_{0n}^{n+1} - \psi^n + \psi^{n+1} = 0$$

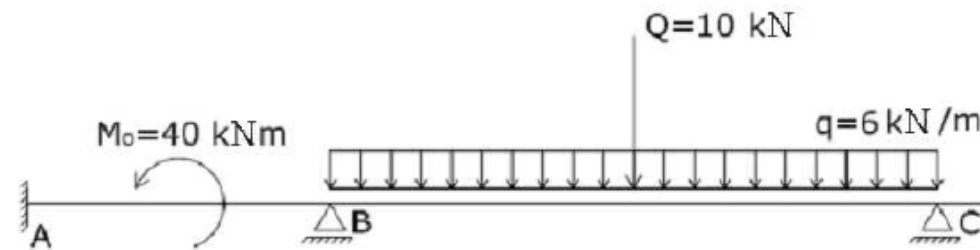

$$M_A\beta^1 + M_B(\alpha_B^1 + \alpha_B^2) + M_C\beta^2 + \alpha_{0B}^1 + \alpha_{0B}^2 - \psi^1 + \psi^2 = 0$$

$$M_A \beta^1 + M_B (\alpha_B^1 + \alpha_B^2) + M_C \beta^2 + \alpha_{0B}^1 + \alpha_{0B}^2 - \psi^1 + \psi^2 = 0$$

$$\alpha_{0B}^1 = -\alpha_{0A}^1 = -\frac{M_0 \cdot L^1}{24 \cdot EI} = -\frac{40000 \times 2}{24 \cdot EI}$$

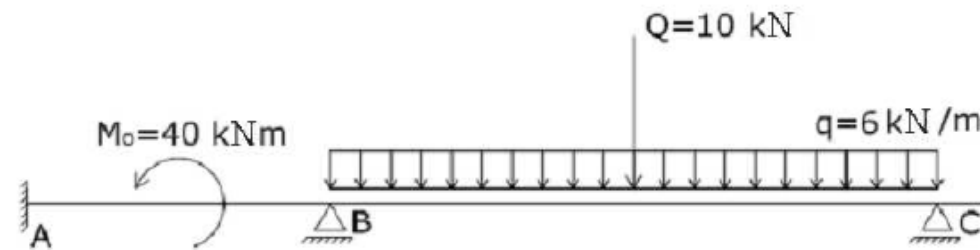

C

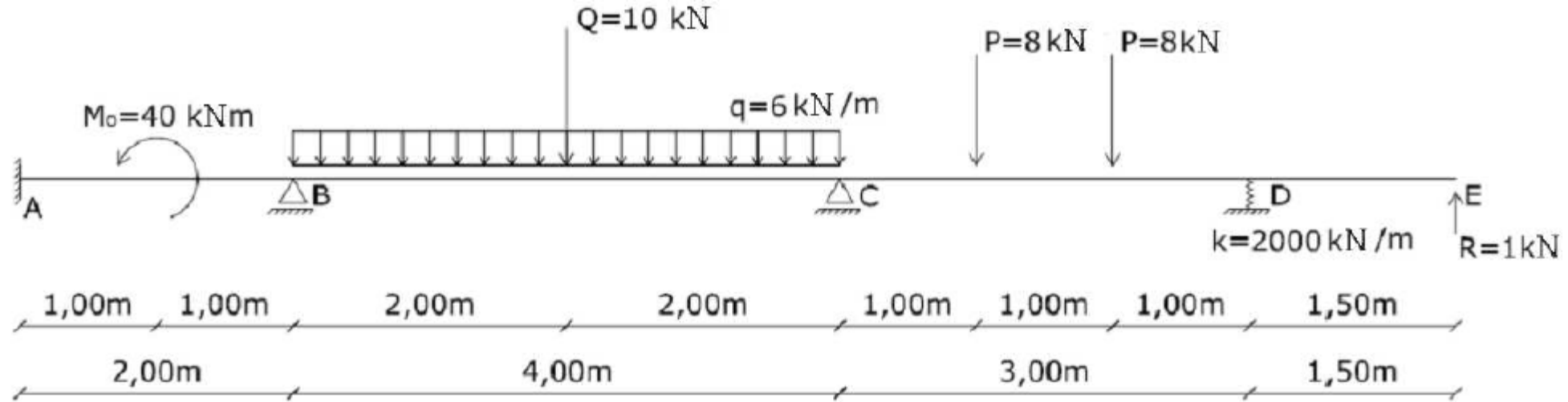

$$M_A \beta^1 + M_B (\alpha_B^1 + \alpha_B^2) + M_C \beta^2 + \alpha_{0B}^1 + \alpha_{0B}^2 - \psi^1 + \psi^2 = 0$$

$$\alpha_{0B}^2 = \frac{q \cdot (L^2)^3}{24 \cdot EI} + \frac{Q \cdot (L^2)^2}{16 \cdot EI} = \frac{6000 \times 4^3}{24 \cdot EI} + \frac{10000 \times 4^2}{16 \cdot EI} = \alpha_{0C}^2$$

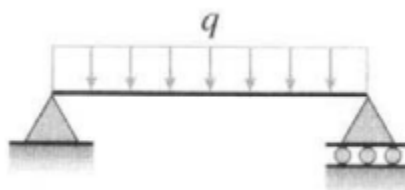

$$\theta_A = \theta_B = \frac{qL^3}{24EI}$$

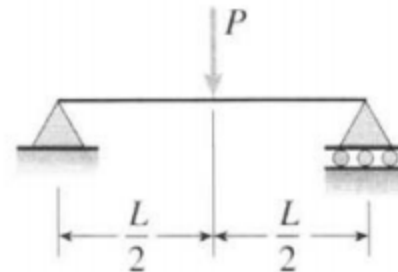

$$\theta_A = \theta_B = \frac{PL^2}{16EI}$$

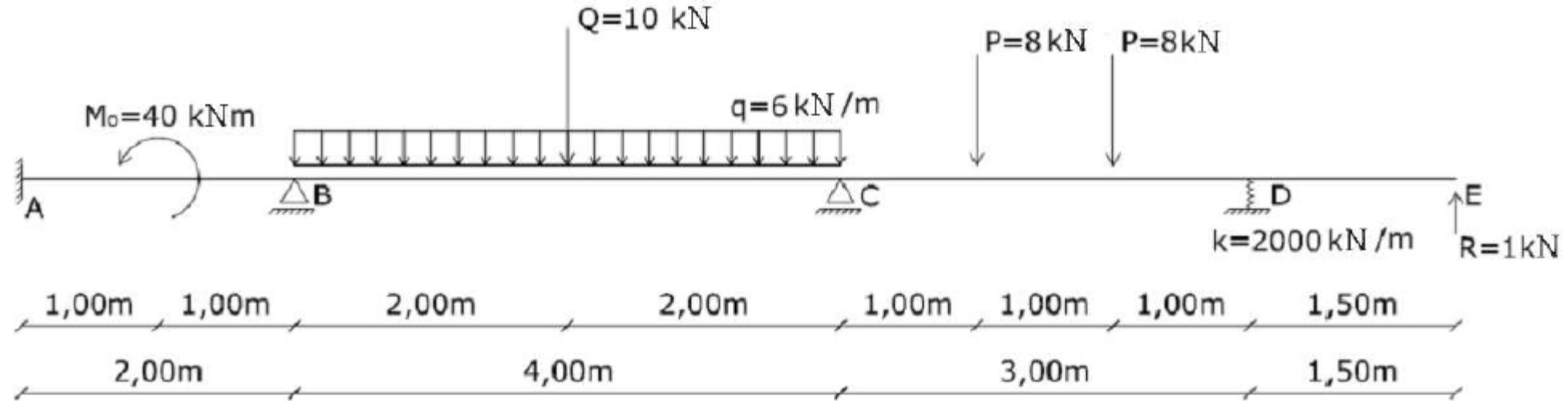

$$M_A \beta^1 + M_B (\alpha_B^1 + \alpha_B^2) + M_C \beta^2 + \alpha_{0B}^1 + \alpha_{0B}^2 - \psi^1 + \psi^2 = 0$$

$$\alpha_B^1 = \alpha_A^1 = \frac{L^1}{3 \cdot EI} = \frac{2}{3 \cdot EI} \quad \alpha_B^2 = \frac{L^2}{3 \cdot EI} = \frac{4}{3 \cdot EI}$$

$$\beta^2 = \frac{L^2}{6 \cdot EI} = \frac{4}{6 \cdot EI}$$

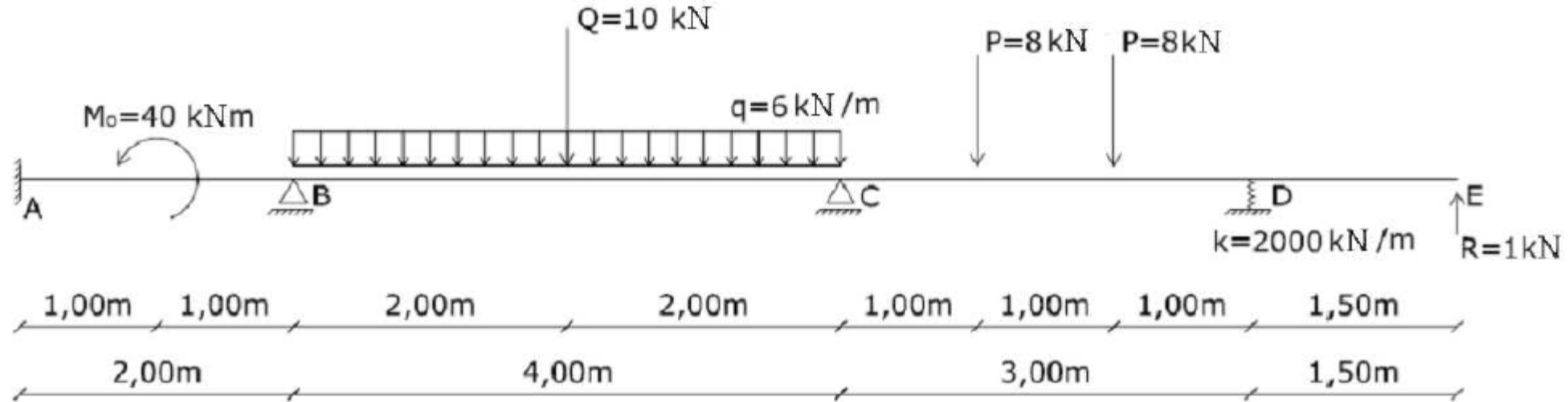

$$M_A \beta^1 + M_B (\alpha_B^1 + \alpha_B^2) + M_C \beta^2 + \alpha_{0B}^1 + \alpha_{0B}^2 - \psi^1 + \psi^2 = 0$$

$$M_A \frac{2}{6 \cdot EI} + M_B \left( \frac{2}{3 \cdot EI} + \frac{4}{3 \cdot EI} \right) + M_C \frac{4}{6 \cdot EI} - \frac{40000 \times 2}{24 \cdot EI} + \frac{6000 \times 4^3}{24 \cdot EI} + \frac{10000 \times 4^2}{16 \cdot EI} = 0$$

$$M_A + 6 \cdot M_B + 2 \cdot M_C = -68000 Nm$$

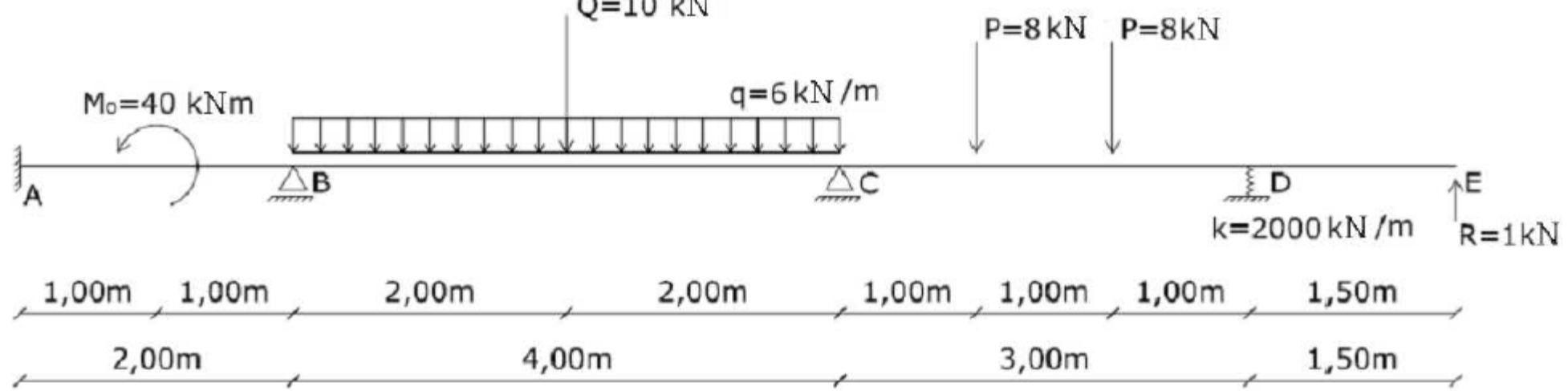

Aplicamos 3 Momentos en el apoyo C con términos de carga

$$M_{n-1}L^n + 2M_n(L^n + L^{n+1}) + M_{n+1}L^{n+1} + \mathcal{R}^n L^n + \mathcal{L}^{n+1} L^{n+1} + 6EI_x(\psi^{n+1} - \psi^n) = 0$$

$$M_B \cdot L^2 + 2 \cdot M_C(L^2 + L^3) + M_D \cdot L^3 + L^2 \cdot \mathcal{R}^2 + L^3 \cdot \mathcal{L}^3 + 6 \cdot EI(\psi^3 - \psi^2) = 0$$

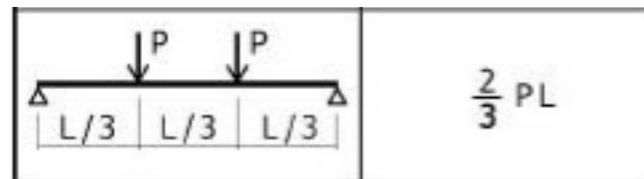
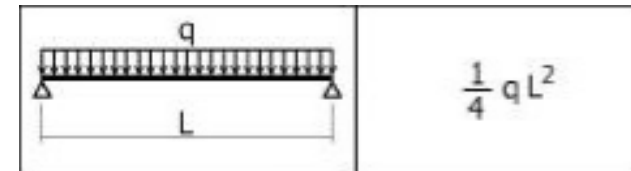
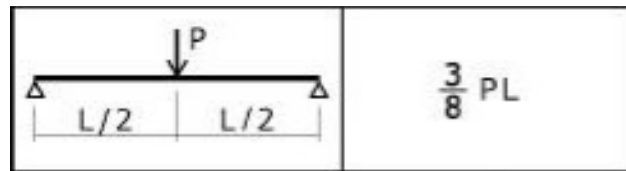

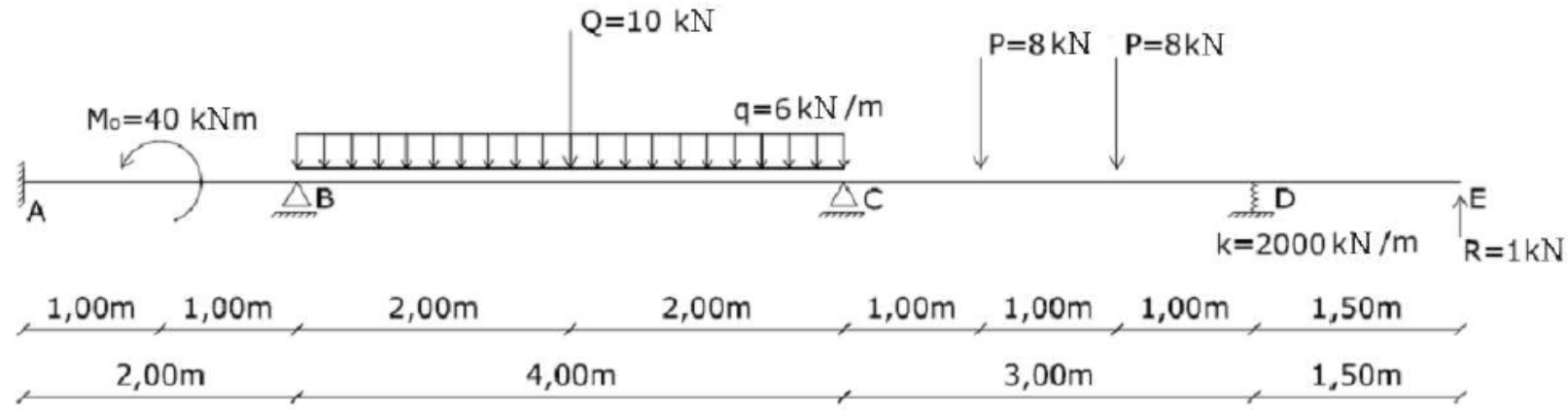

$$M_B \cdot L^2 + 2 \cdot M_C (L^2 + L^3) + M_D \cdot L^3 + L^2 \cdot \mathcal{R}^2 + L^3 \cdot \mathcal{L}^3 + 6 \cdot EI(\psi^3 - \psi^2) = 0$$

$$\mathcal{R}^2 = \frac{3}{8} Q \cdot L^2 + \frac{1}{4} q \cdot (L^2)^2 = \frac{3}{8} \cdot 10000 \times 4 + \frac{1}{4} 6000 \times 4^2 = 39000 \text{ Nm}$$

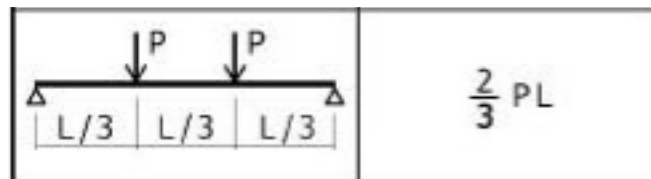
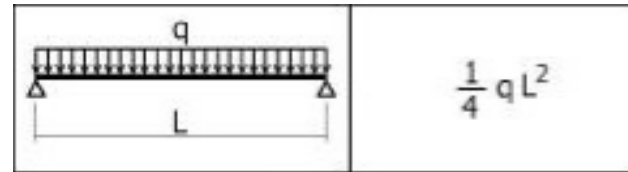
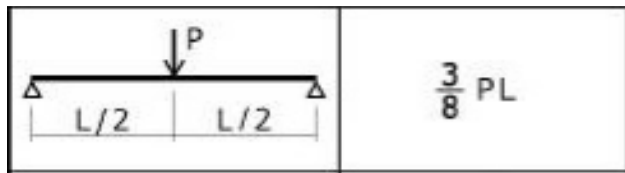

$$\mathcal{L}^3 = \frac{2}{3} \cdot P \cdot L^3 = \frac{2}{3} \cdot 8000 \times 3 = 16000 \text{ Nm}$$



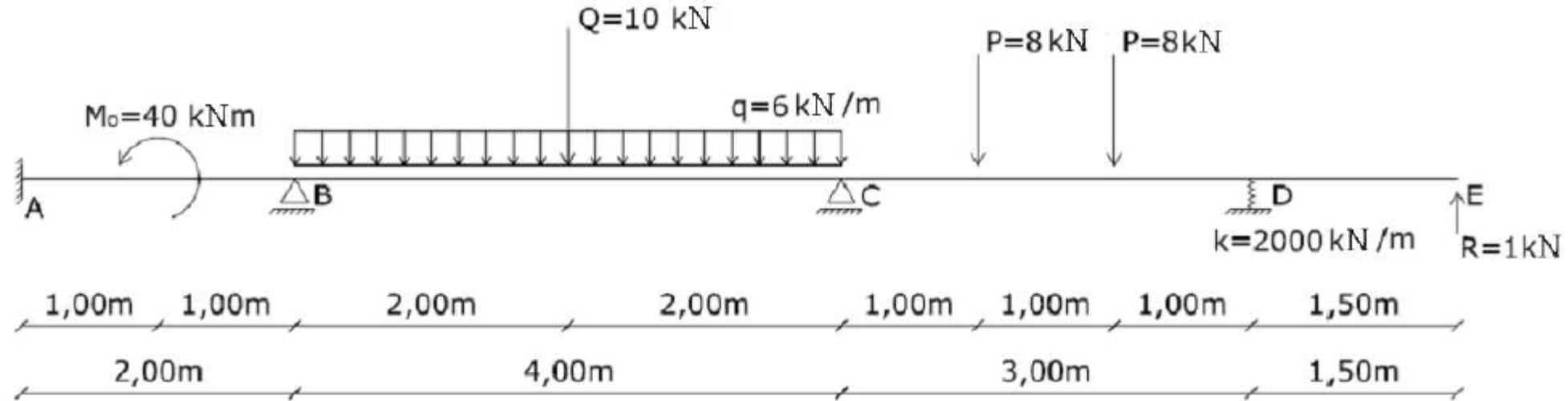

$$M_B \cdot L^2 + 2 \cdot M_C (L^2 + L^3) + M_D \cdot L^3 + L^2 \cdot \mathcal{R}^2 + L^3 \cdot \mathcal{L}^3 + 6 \cdot EI (\psi^3 - \psi^2) = 0$$

$\psi^2$  es igual a cero

$$\psi^3 = \frac{v_D - v_C}{L^3} = \frac{R_D / k - 0}{3} = \frac{R_D}{2 \times 10^6 \times 3}$$

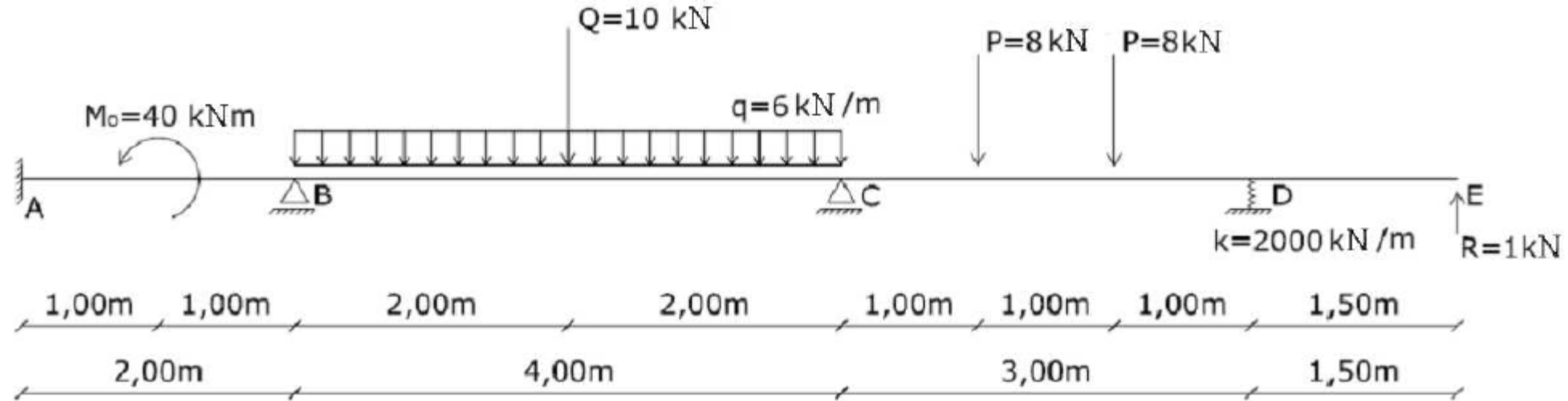

$$M_B \cdot L^2 + 2 \cdot M_C (L^2 + L^3) + M_D \cdot L^3 + L^2 \cdot \mathcal{R}^2 + L^3 \cdot \mathcal{L}^3 + 6 \cdot EI (\psi^3 - \psi^2) = 0$$

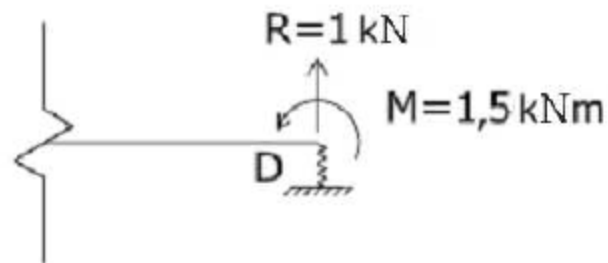

$$R_{0n} + \frac{1}{L^n} (M_{n-1} - M_n) + \frac{1}{L^{n+1}} (M_{n+1} - M_n)$$

$$R_D = P - R + \frac{1}{L^3} (M_C - M_D) = 8000 - 1000 + \frac{M_C}{3} - \frac{1500}{3}$$

$$M_B \cdot L^2 + 2 \cdot M_C (L^2 + L^3) + M_D \cdot L^3 + L^2 \cdot \mathcal{R}^2 + L^3 \cdot \mathcal{L}^3 + 6 \cdot EI(\psi^3 - \psi^2) = 0$$

$$4 \cdot M_B + 2 \cdot M_C (4+3) + 1500 \cdot 3 + 4 \cdot \left( \frac{3}{8} \cdot 10000 \times 4 + \frac{1}{4} \cdot 6000 \times 4^2 \right) + 3 \cdot \frac{2}{3} \cdot 8000 \times 3 + 6EI \left( \frac{R_D}{2 \times 10^6 \times 3} \right) = 0$$

$$R_D = P - R + \frac{1}{L^3} (M_C - M_D) = 8000 - 1000 + \frac{M_C}{3} - \frac{1500}{3}$$

$$4 \cdot M_B + 15,498 \cdot M_C = -23771 \text{ Nm}$$

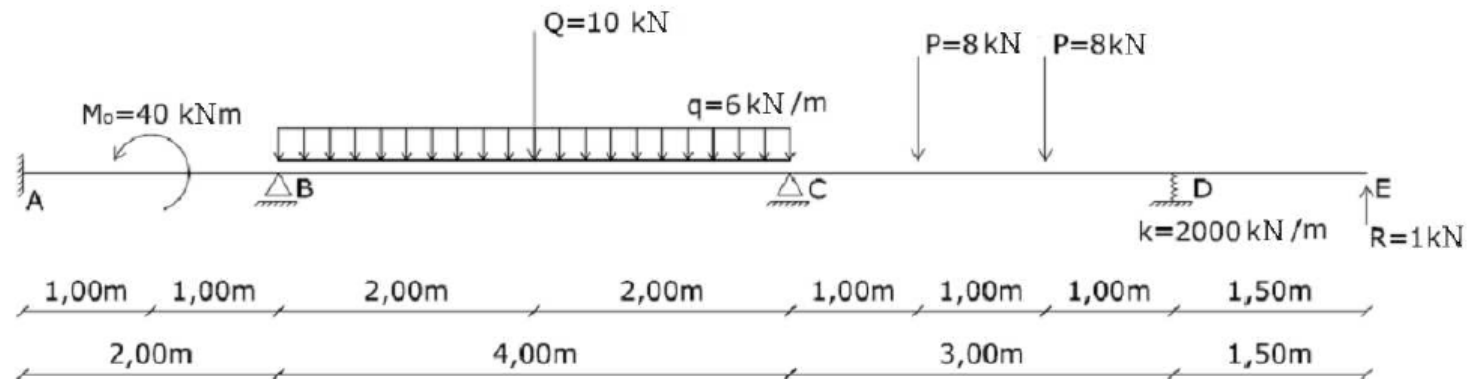

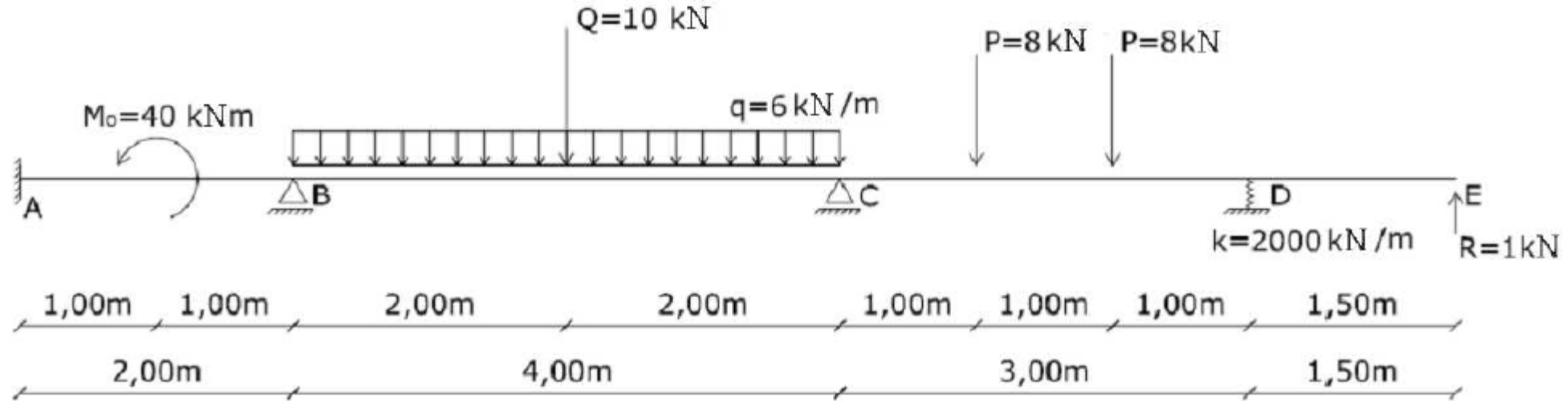

$$4 \cdot M_B + 15,498 \cdot M_C = -23771 \text{ Nm}$$

$$M_A + 6 \cdot M_B + 2 \cdot M_C = -68000 \text{ Nm}$$

$$2 \cdot M_A + M_B = -10000 \text{ Nm}$$

$$M_A = -1757,13 \text{ Nm}$$

$$M_B = -6485,74 \text{ Nm}$$

$$M_C = -13664,22 \text{ Nm}$$

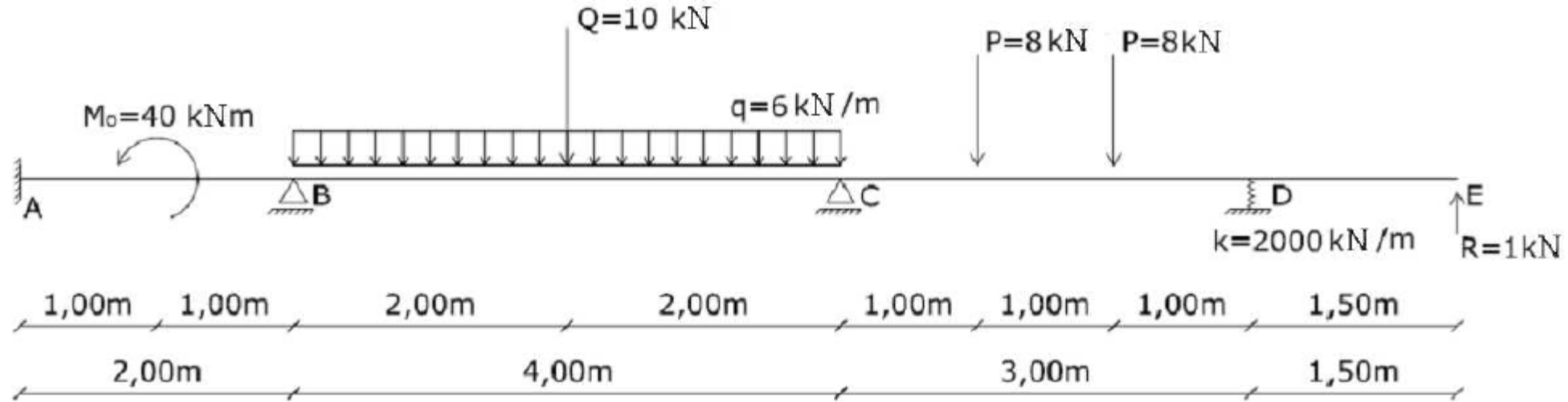

$$v_D = \frac{R_D}{k} = \left( 8000 - 1000 + \frac{-13664,22}{3} - \frac{1500}{3} \right) \frac{1}{2,0 \times 10^6} = 0,000973\text{m} = 0.973\text{mm}$$

$$R_n = R_1 = R_{0,1} - \frac{M_1}{L^1} - \frac{M_1}{L^2} + \frac{M_2}{L^2}$$

$$R_A = \frac{M_0}{L^1} + \frac{1}{L^1} (M_B - M_A) = 17635,70\text{N}$$

$$R_n = R_{0_n}^n + R_{0_n}^{n+1} + \frac{M_{n-1}}{L^n} - \frac{M_n}{L^n} - \frac{M_n}{L^{n+1}} + \frac{M_{n+1}}{L^{n+1}} =$$

$$R_B = -\frac{M_0}{L^1} + \quad Q/2 + q L^2/2 \quad + \frac{1}{L^1} (M_A - M_B) + \frac{1}{L^2} (M_C - M_B) = -2430,32\text{N}$$

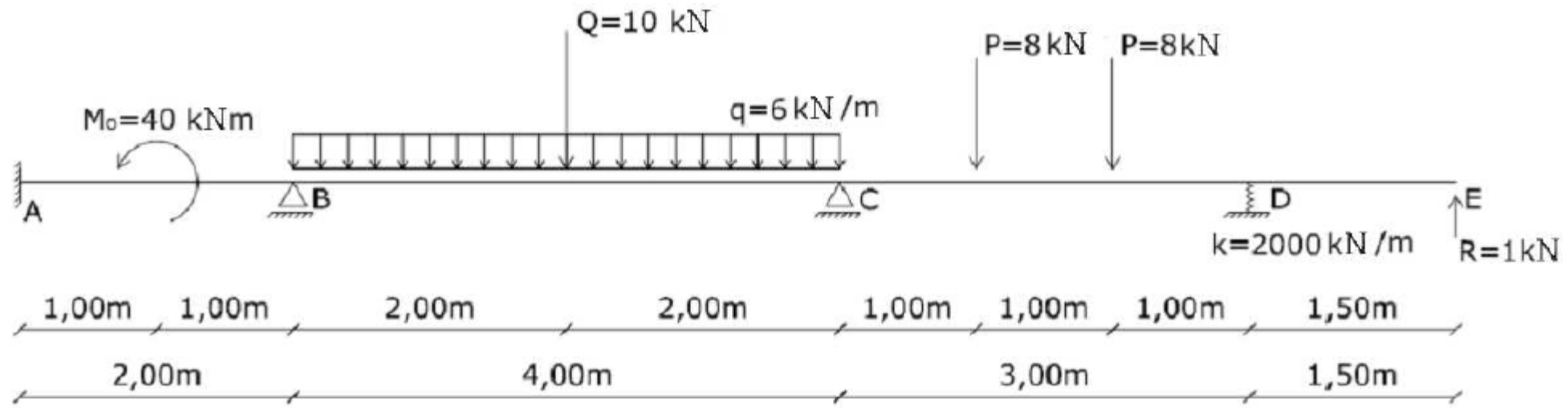

$$R_n = R_{0n}^n + R_{0n}^{n+1} + \frac{M_{n-1}}{L^n} - \frac{M_n}{L^n} - \frac{M_n}{L^{n+1}} + \frac{M_{n+1}}{L^{n+1}} =$$

$$R_C = Q/2 + q \cdot 4m/2 + P + \frac{1}{L^2} (M_B - M_C) + \frac{1}{L^3} (M_D - M_C) = 31849,36N$$

