

Pórticos

- Introducción
- Tensiones normales compuestas

Gere, 5ª Ed. (2002): 5.12

Ortiz Berrocal, 3ª Ed. (2007): 6.5

Beer, 3ª Ed. (2004): 4.12

Flexión compuesta

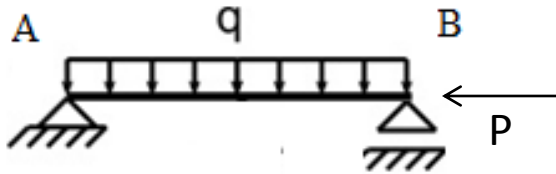

Tensión normal por directa :

$$\sigma_N = \frac{N}{A}$$

Fórmula de tensión por flexión :

$$\sigma_M = -\frac{M \cdot y}{I}$$

Tensiones normal en flexión compuesta:

$$\sigma = \frac{N}{A} - \frac{M \cdot y}{I}$$

Observación:

En flexión compuesta, el **eje neutro** ya **no pasa por el baricentro** de la sección.

Flexión Compuesta

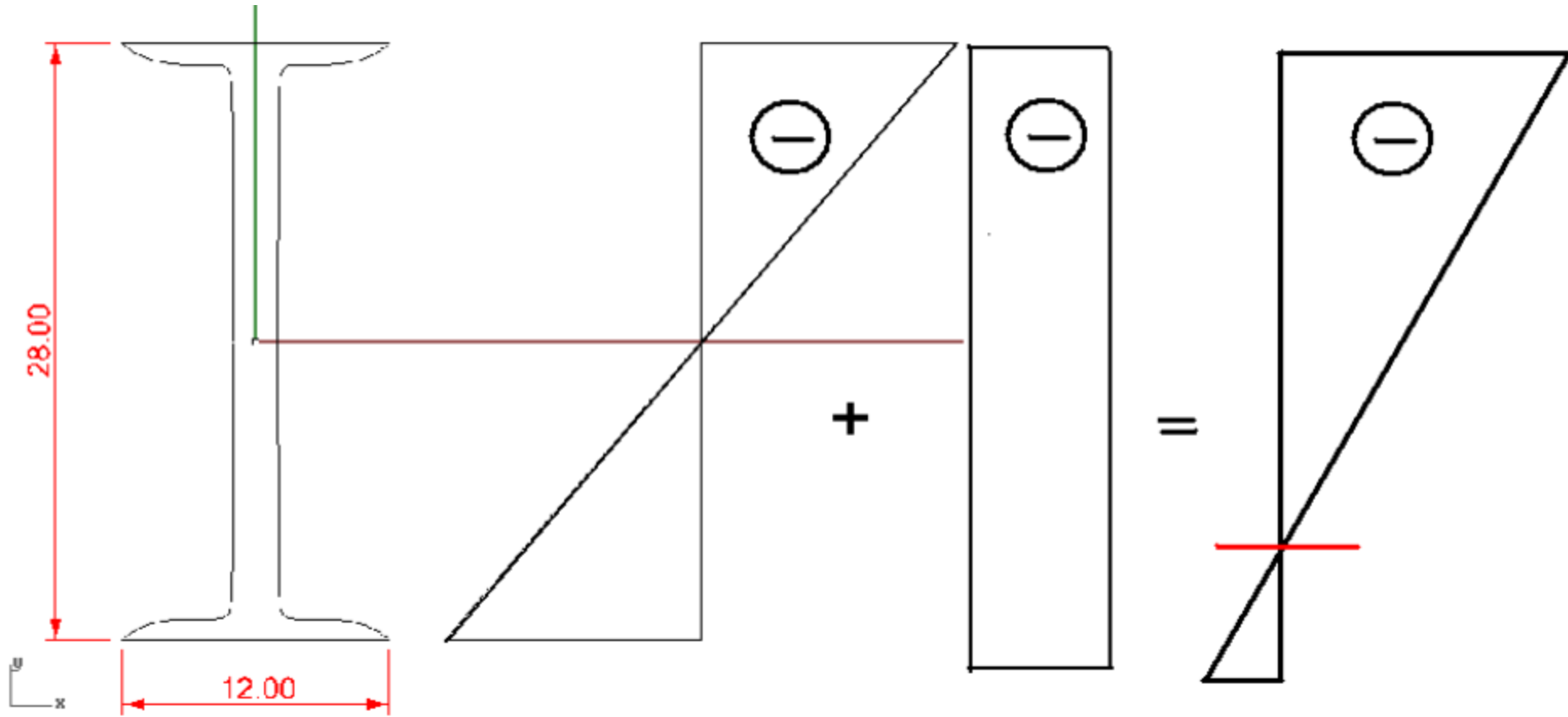

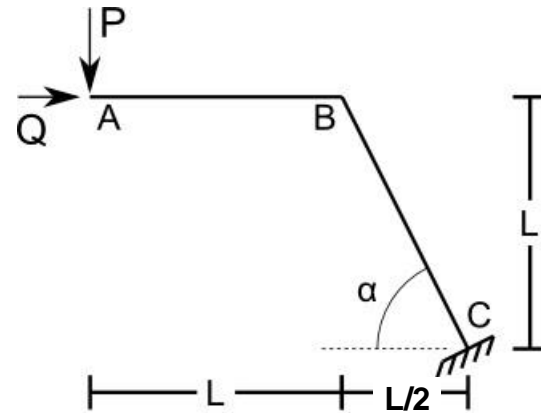
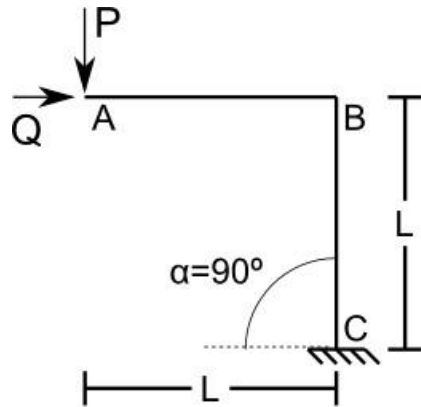

Caso particular de barras en ángulo ortogonal.

En B: $N^I = V^D$
 $V^I = N^D$
 $M^I = M^D$

Es decir, el cortante y la directa se invierten, y el momento se transmite.

Ejemplo

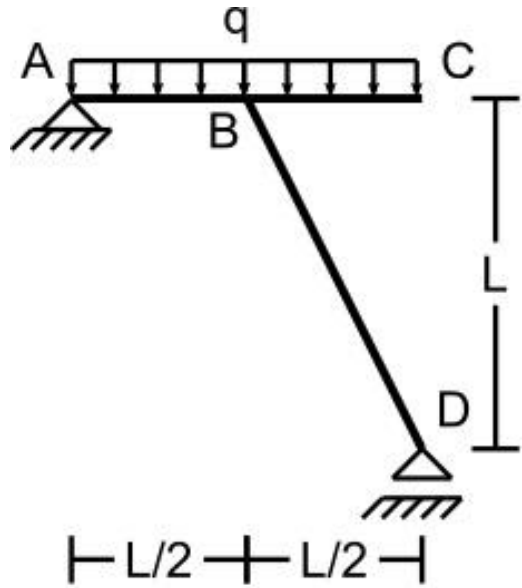

$$\text{Sum}(F_v)=0$$

$$R_A + R_D = qL$$

$$\text{Sum}(M_A)=0$$

$$q \cdot L \cdot L/2 - R_D \cdot L = 0$$

$$R_D = qL/2$$

$$R_A = qL/2$$

$$\cos(\alpha) = 1/\text{raíz}(5)$$

$$\text{sen}(\alpha) = 2/\text{raíz}(5)$$

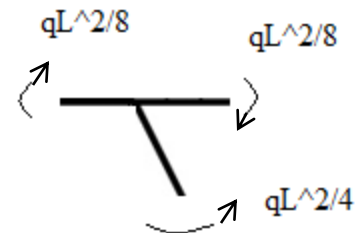
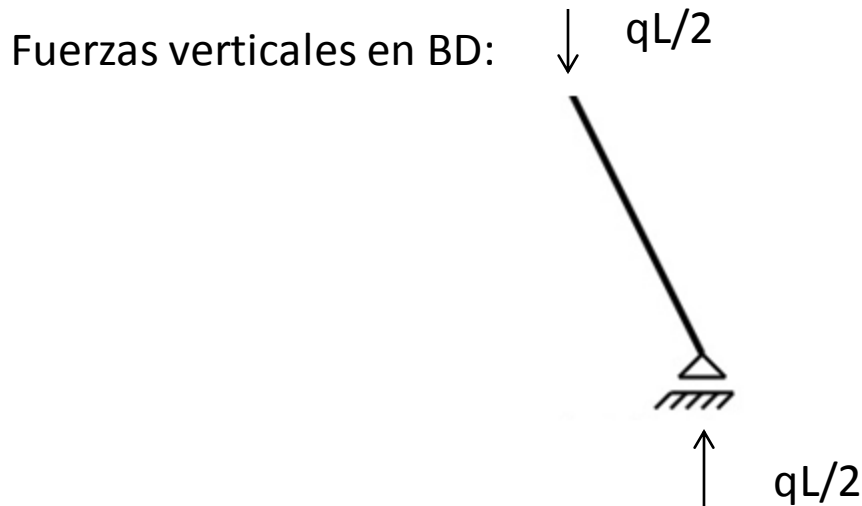

Diagramas

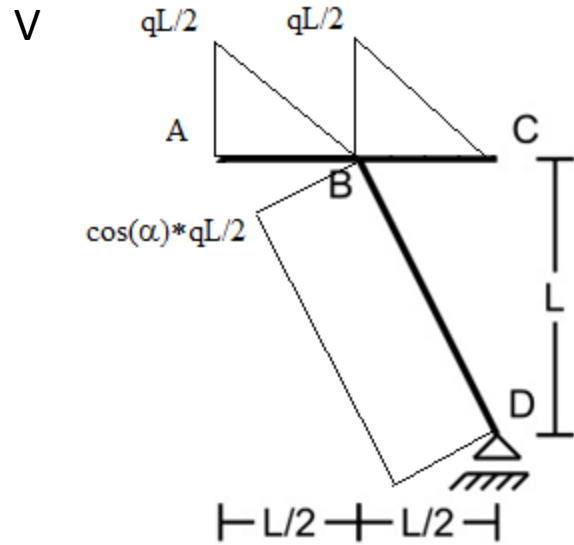

Momentos en el nudo=0

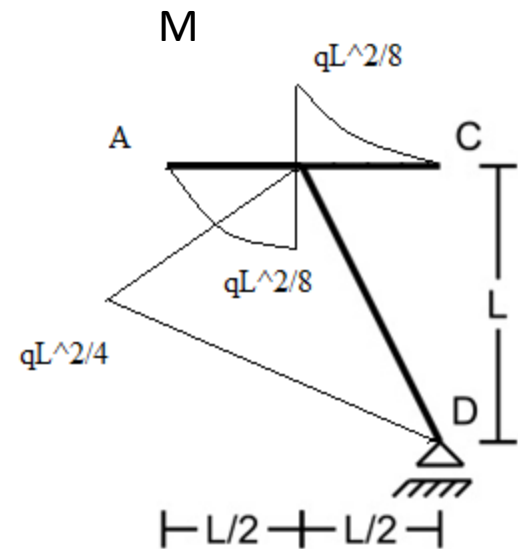
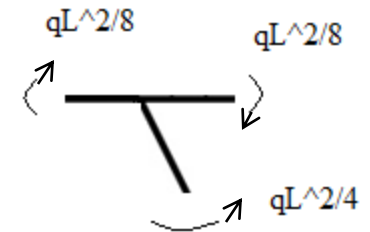

Ejemplo

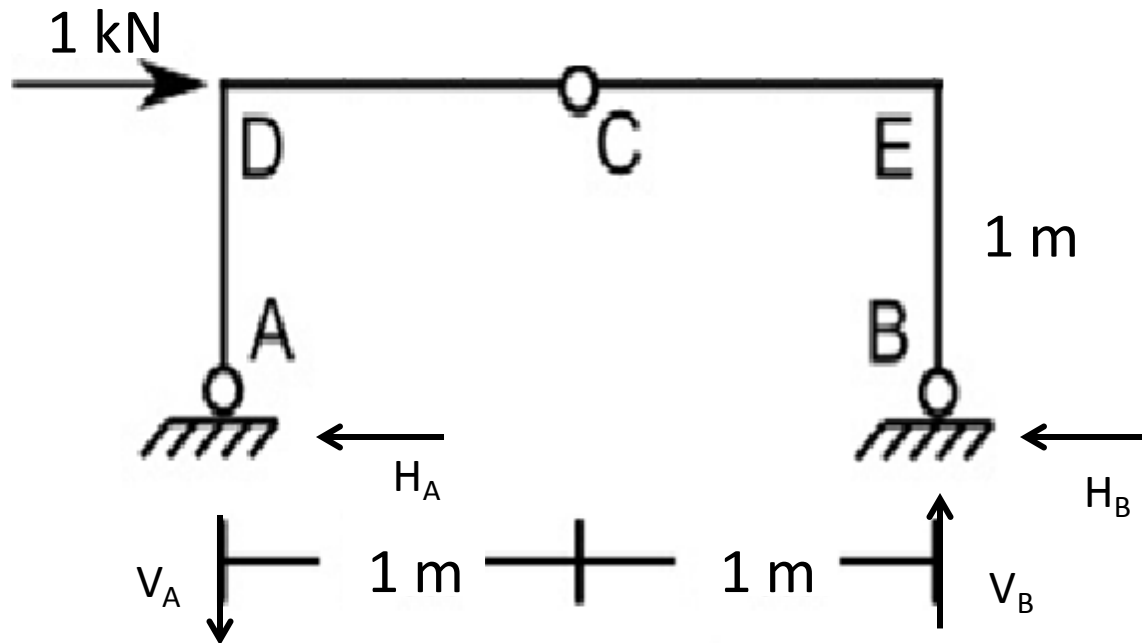

$$\begin{aligned} -V_A + V_B &= 0 \\ H_A + H_B &= 1 \text{ kN} \end{aligned}$$

$$\begin{aligned} \text{Sum}(M_A) &= 0 \\ \text{Sum}(M_{izqC}) &= 0 \end{aligned}$$

V(kN)

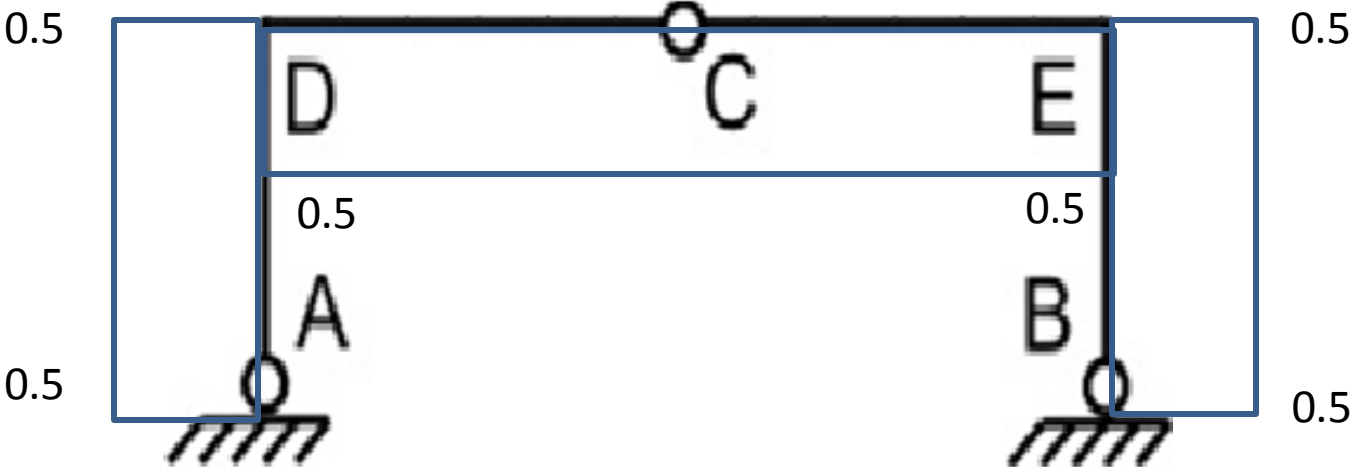

M(kN.m)

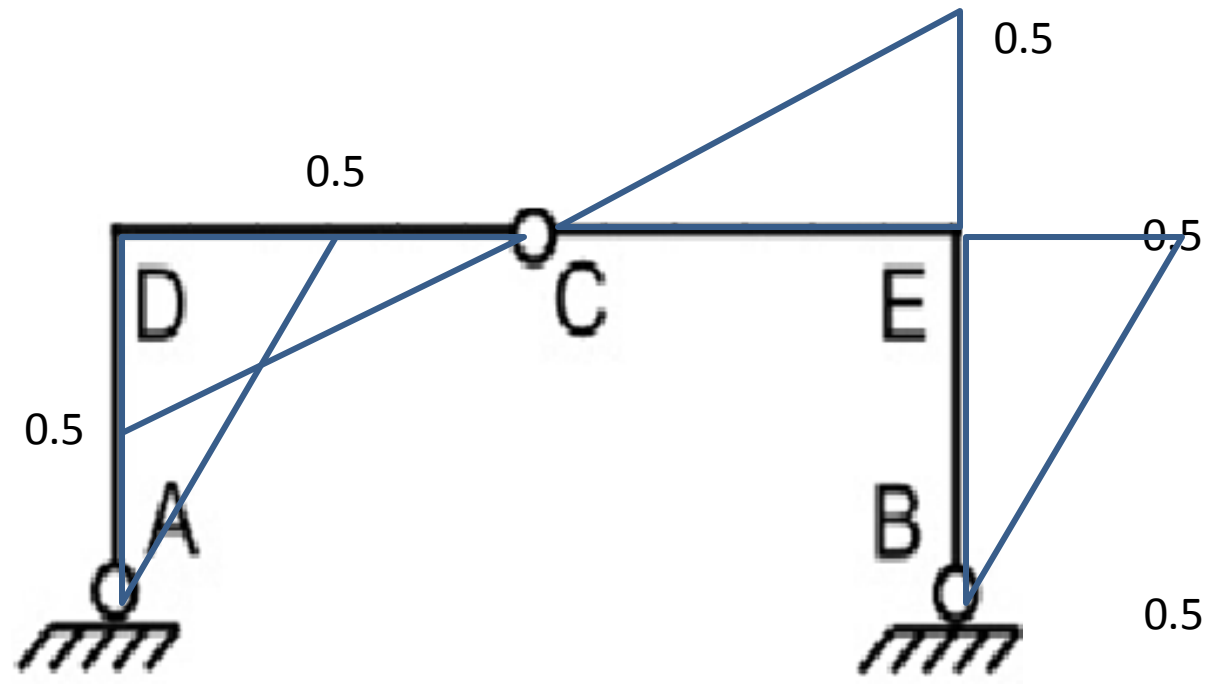

Ejemplo

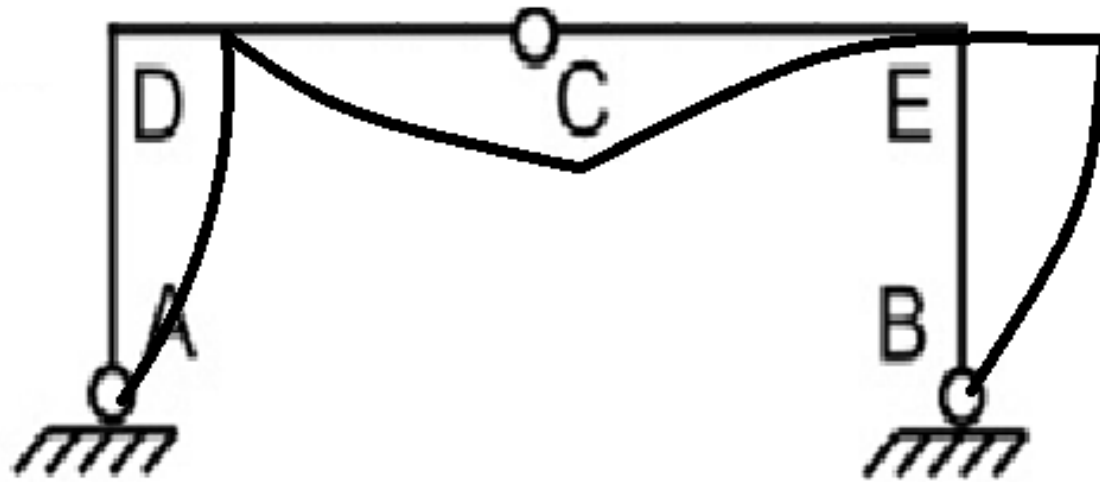

Arco de tres articulaciones

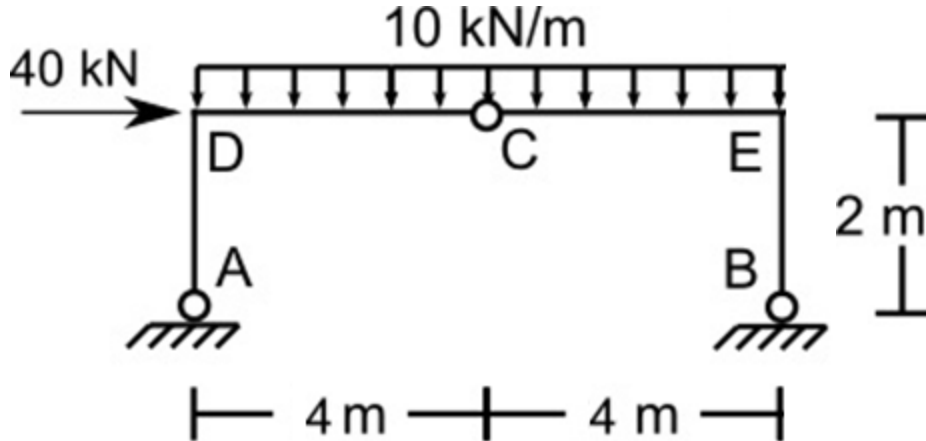

$$\text{Suma}(M_A)=0$$

$$40 \cdot 2 + 10 \cdot 8 \cdot 4 = 8 \cdot V_B \rightarrow V_B = 50 \text{ kN}$$

$$\text{Suma}(F_V) = V_A + 50 - 10 \cdot 8 = 0$$

$$V_A = 30 \text{ kN}$$

$$\text{Suma}(M_{\text{derc}}) = 4 \cdot 10 \cdot 2 - 50 \cdot 4 + H_B \cdot 2$$

$$H_B = 60 \text{ kN}$$

$$H_A = 20 \text{ kN}$$

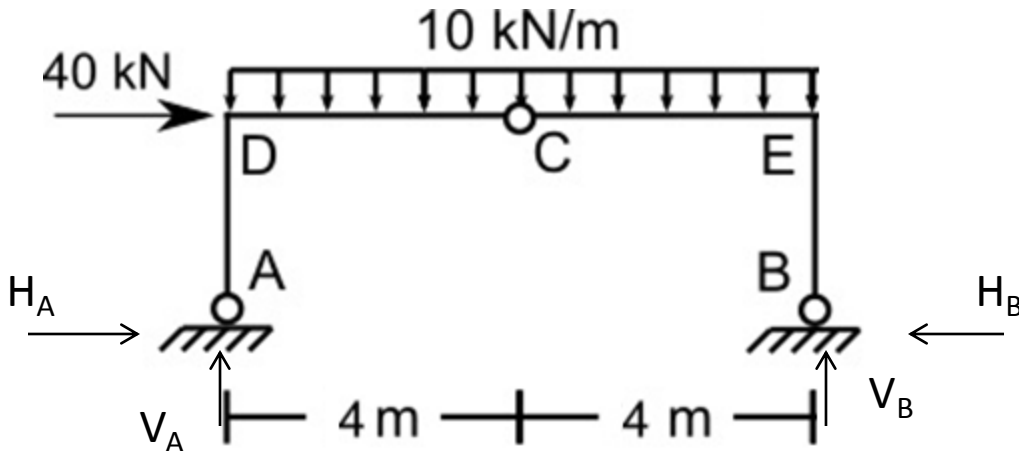

Reacciones

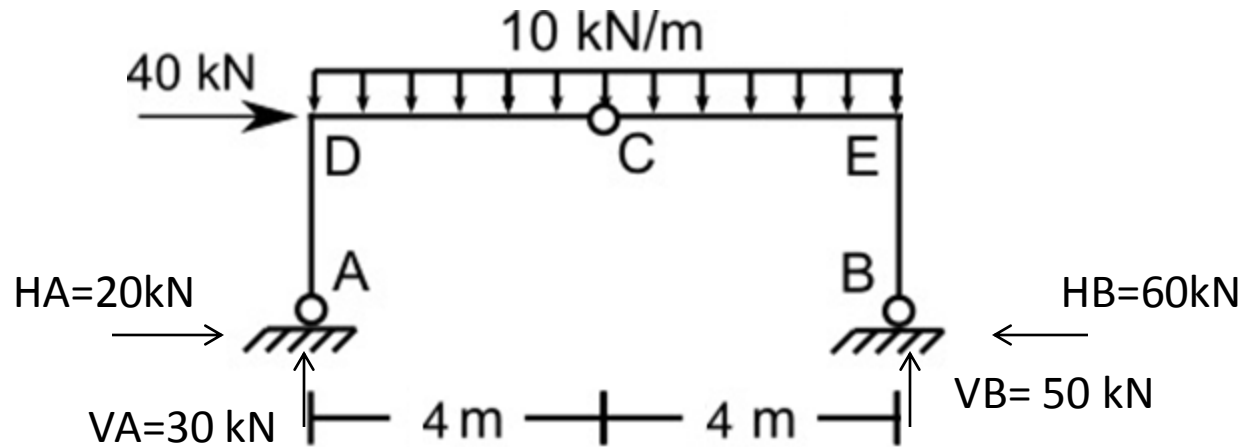

Diagramas

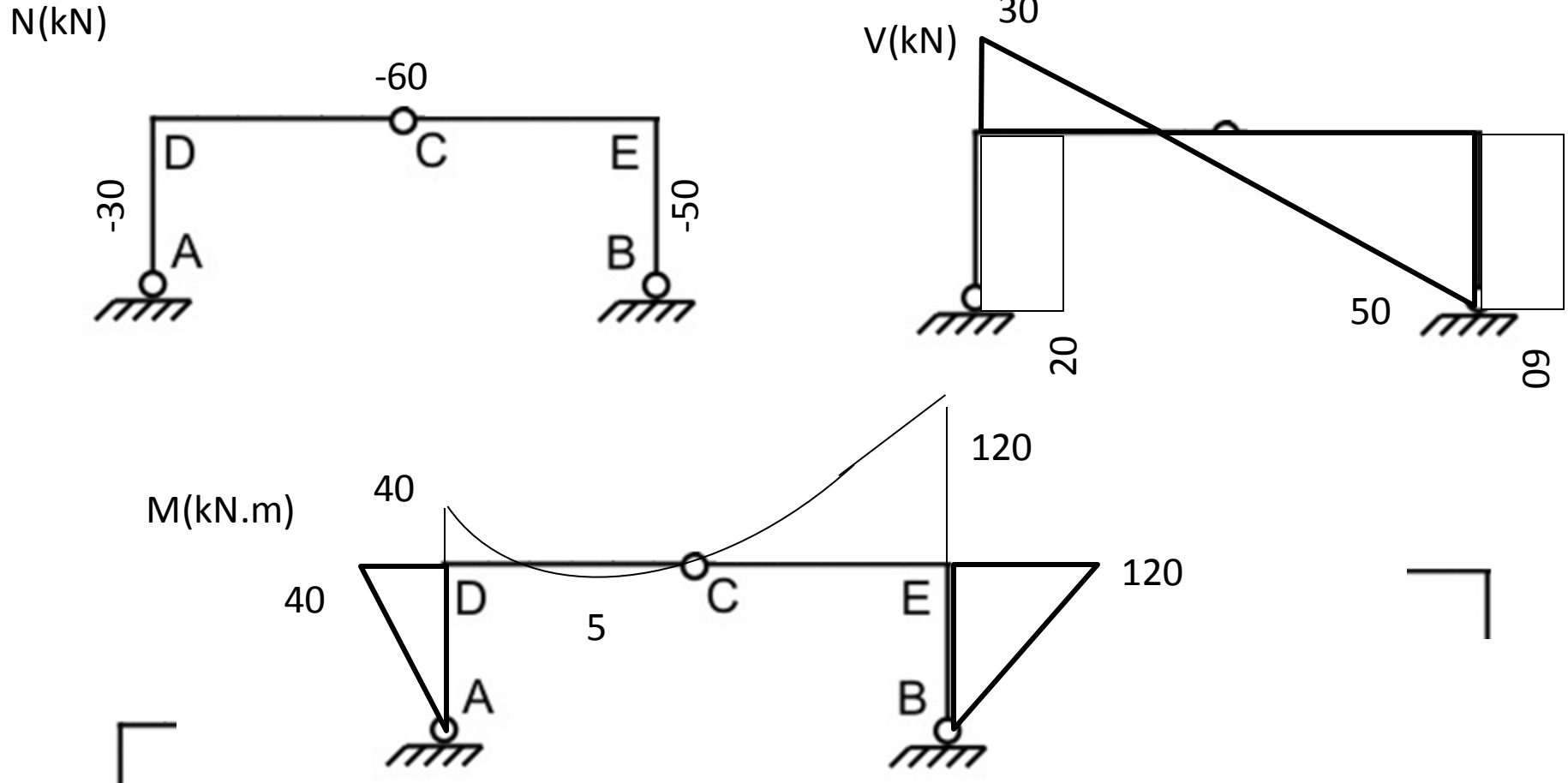

Arco de tres articulaciones

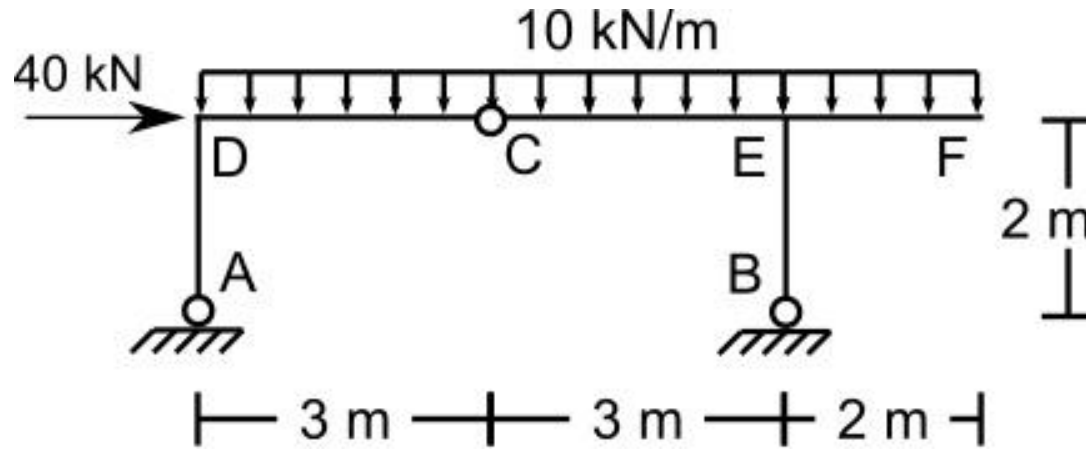

$$\text{Suma}(M_A) = 0 \quad 40 \cdot 2 + 10 \cdot 8 \cdot 4 - V_B \cdot 6 = 0 \quad \rightarrow V_B = 66.7 \text{ kN}$$

$$\text{Suma}(F_V) = 0 \quad V_A + V_B = 80 \quad \rightarrow V_A = 13.3 \text{ kN}$$

$$\text{Suma}(M_{\text{derC}}) = 0 \quad 10 \cdot 5 \cdot 2.5 - 66.7 \cdot 3 + H_B \cdot 2 = 0 \quad \rightarrow H_B = 37.5 \text{ kN}$$

$$H_A = 2.5 \text{ kN}$$

Reacciones

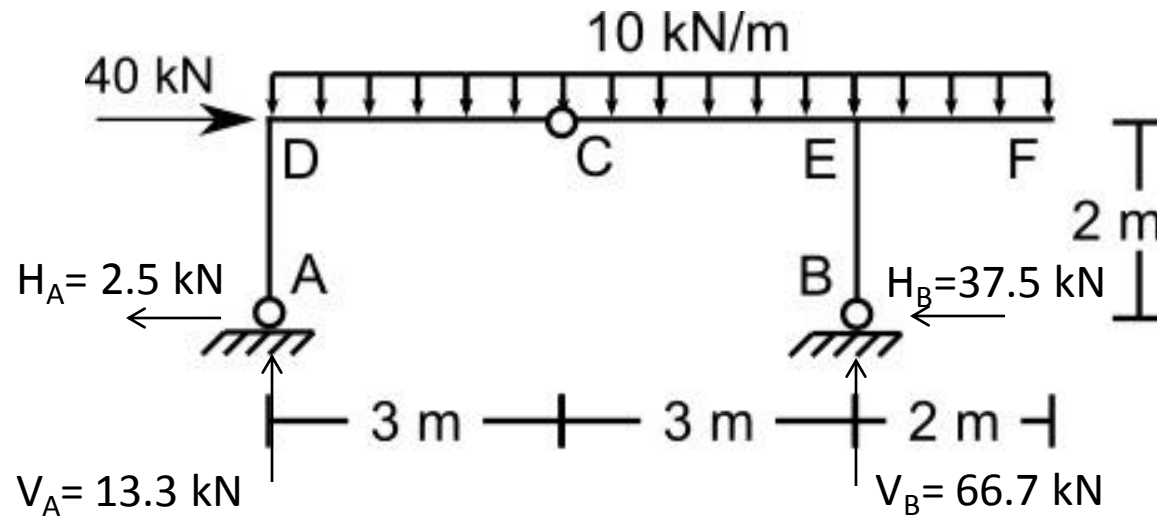

N(kN)

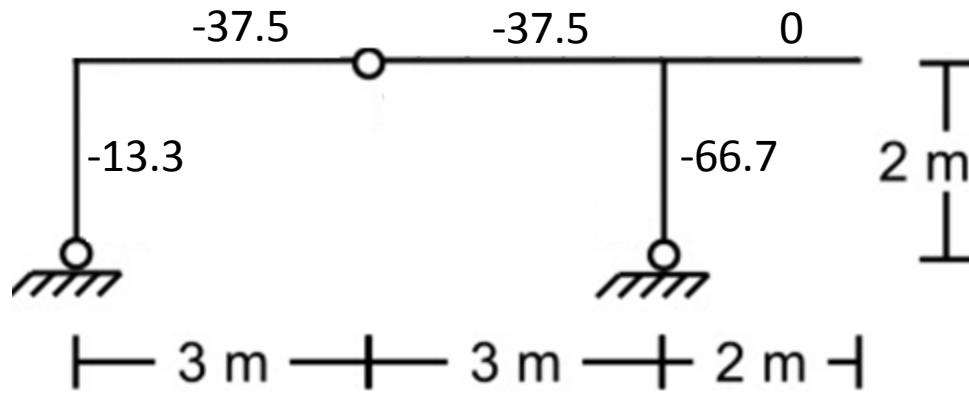

V(kN)

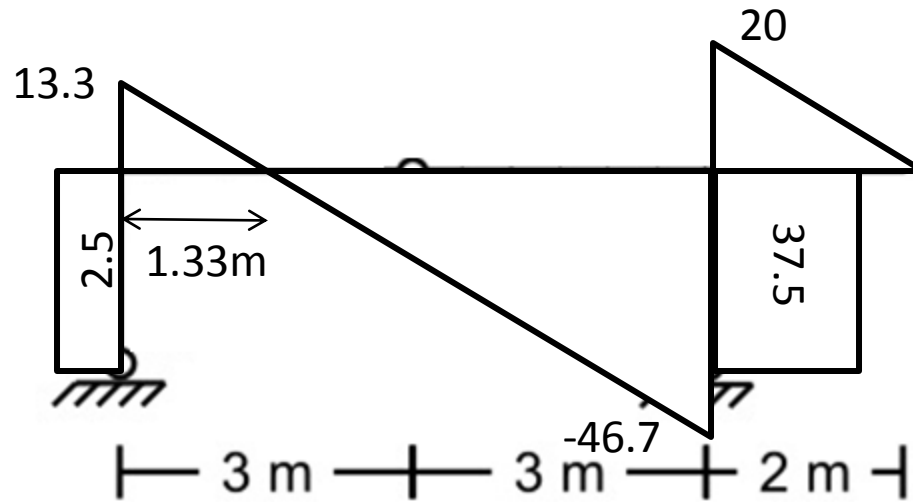

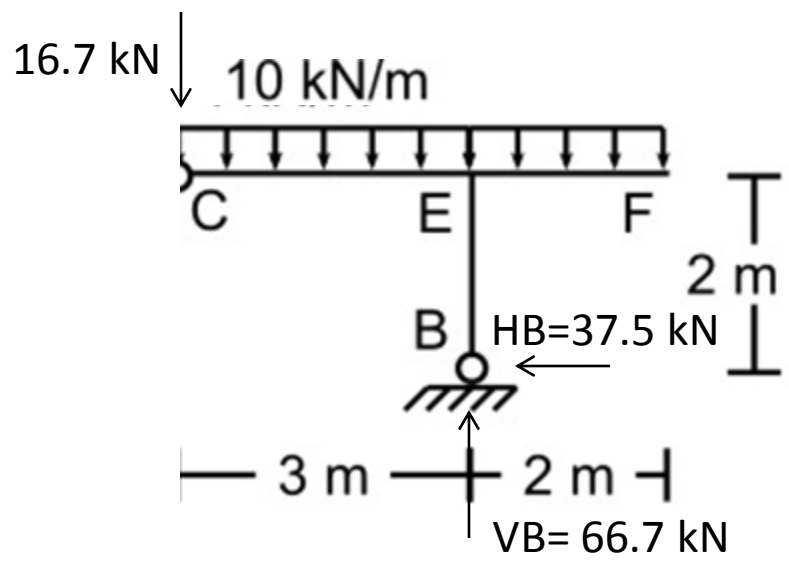
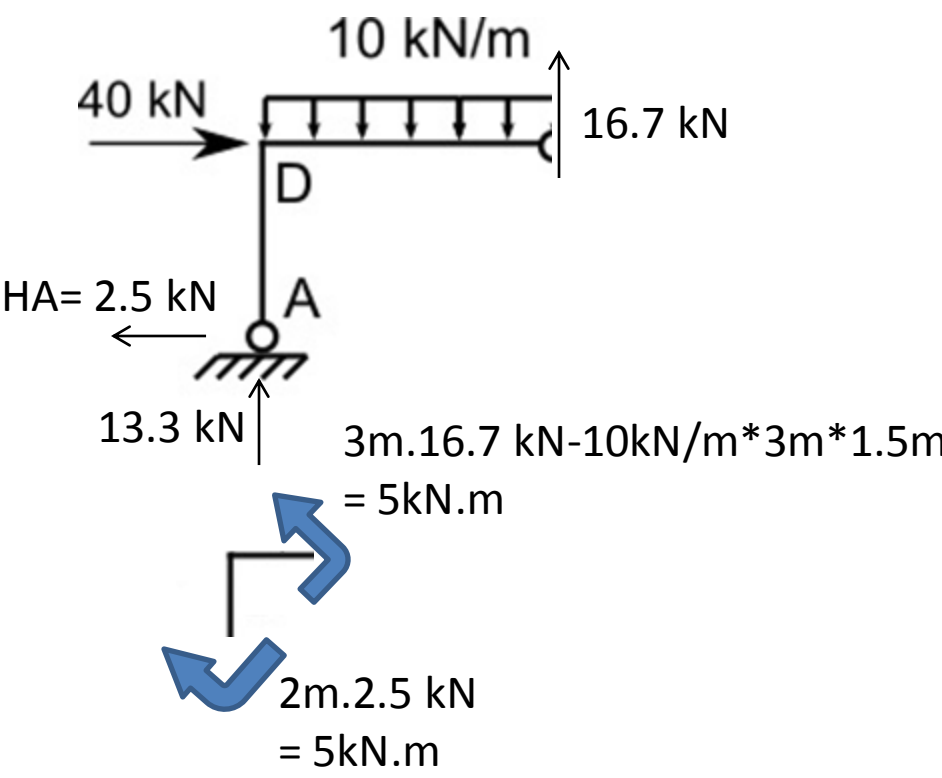

$3 \cdot 16.7 + 10 \cdot 3 \cdot 1.5 = 95 \text{ kN.m}$

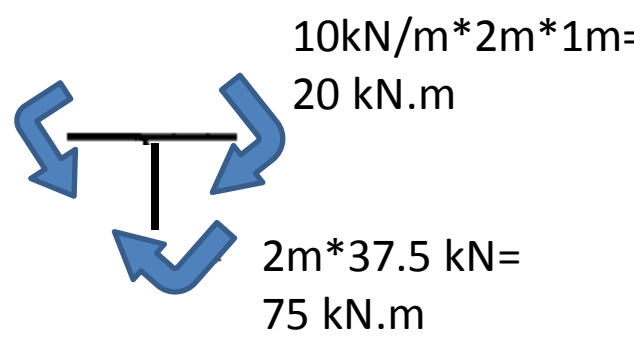

M(kN.m)

$5 + 1.33 * 13.3 / 2 = 13.8 \text{ kNm}$

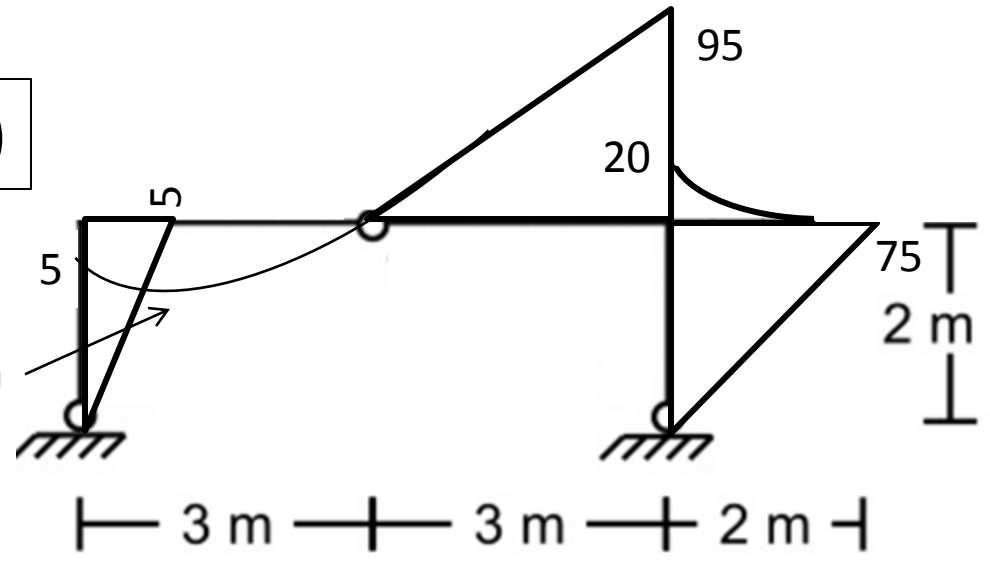

Ejemplo

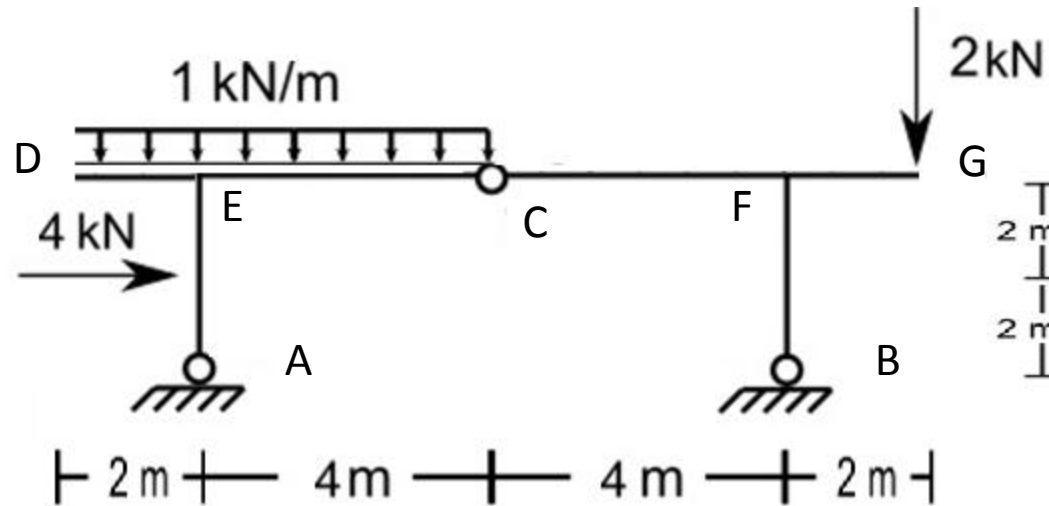

$$\text{Suma}(FV)=0$$

$$V_A+V_B=2+6$$

$$\text{Suma}(FH)=0$$

$$H_A+H_B=4$$

$$V_A=3.75 \text{ kN}$$

$$\text{Suma}(MA)=0$$

$$4 \cdot 2 + 4 \cdot 2 - 2 \cdot 1 + 2 \cdot 10 - 8 \cdot V_B = 0 \rightarrow V_B = 4.25 \text{ kN}$$

$$\text{Suma}(MC_{\text{derecha}})=0$$

$$-V_B \cdot 8 + H_B \cdot 4 + 2 \cdot 6 = 0 \rightarrow H_B = 1.25 \text{ kN}$$

$$H_A = 2.75 \text{ kN}$$

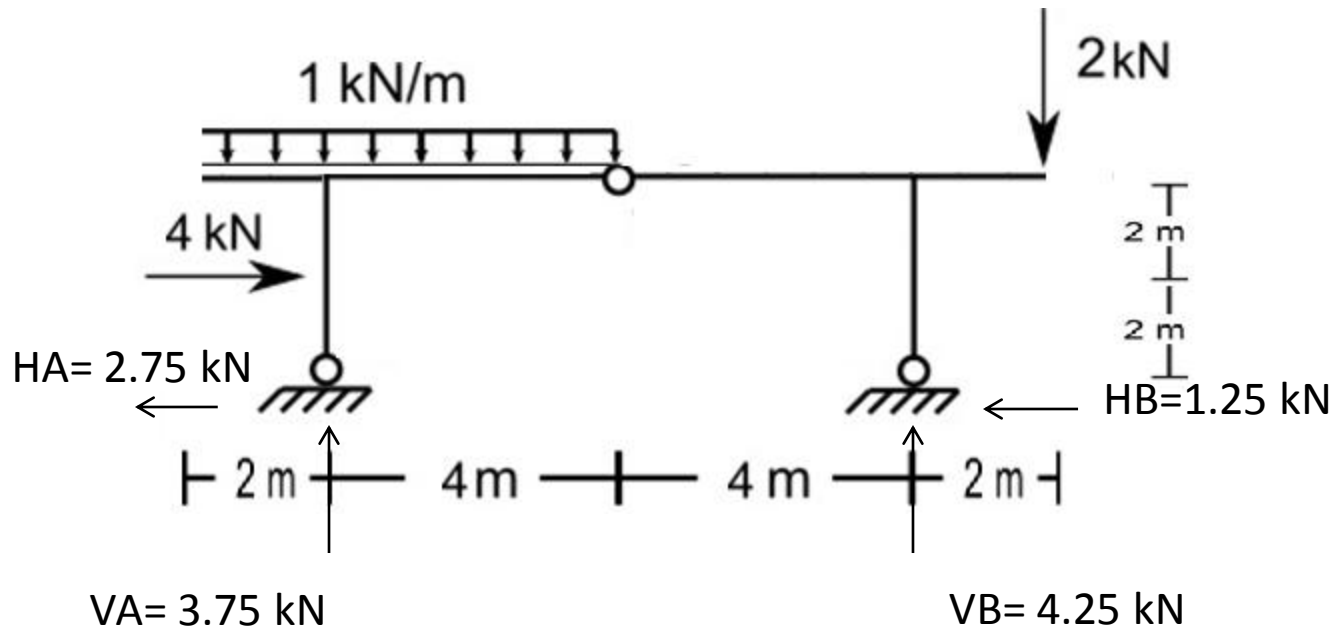

N(kN)

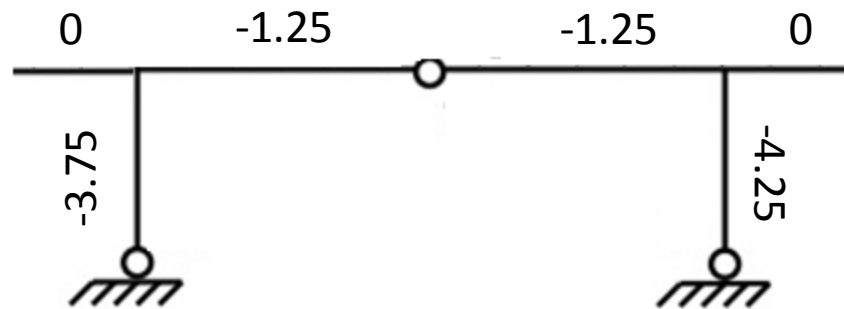

V(kN)

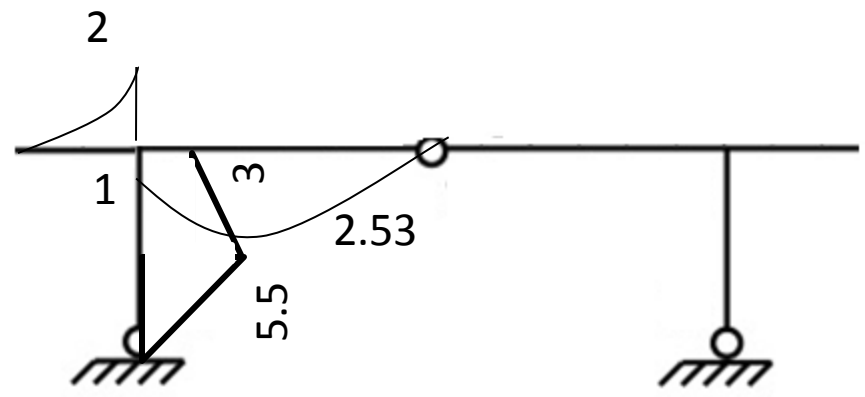
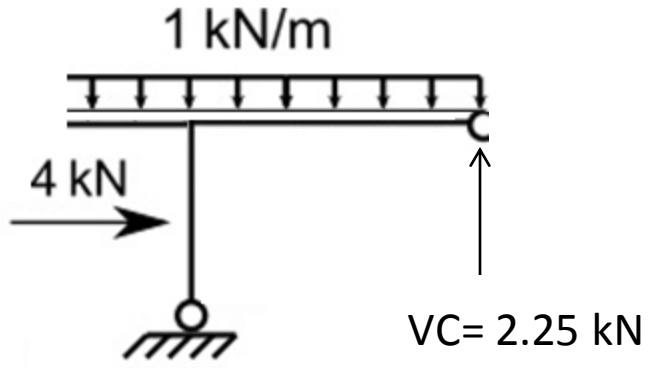
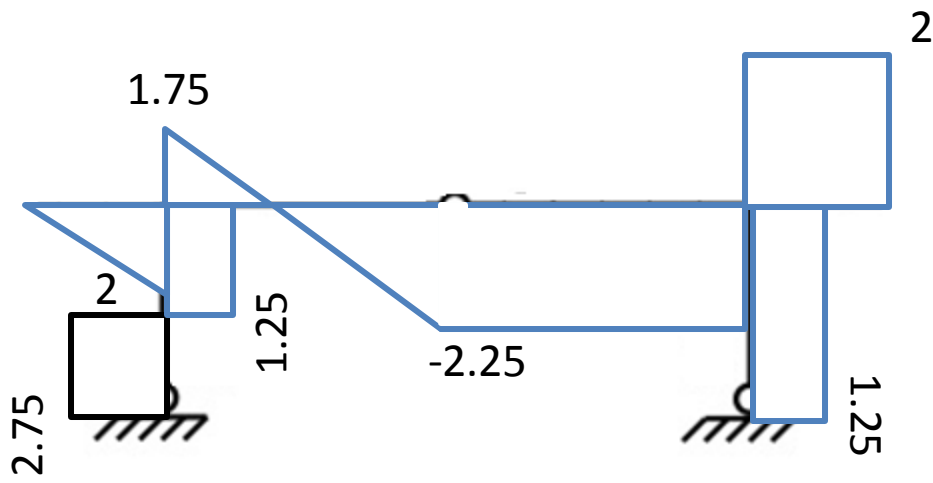

$2 \text{ kNm} = 2 * 1$

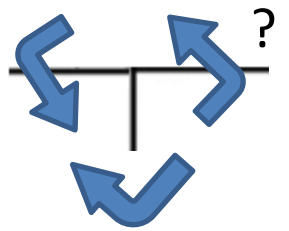

$3 \text{ kNm} = -2.75 \text{ kN} \cdot 4 \text{ m} + 4 \text{ kN} \cdot 2 \text{ m}$

$1 \text{ kNm} = 2.25 \text{ kN} \cdot 4 \text{ m} - 4 \text{ kN} \cdot 2 \text{ m}$

M(kN.m)

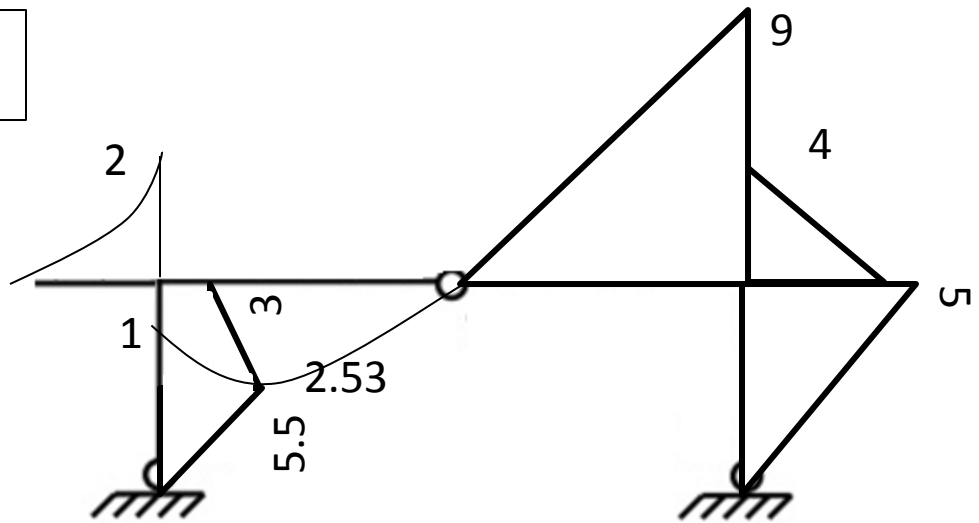

Carga distribuida

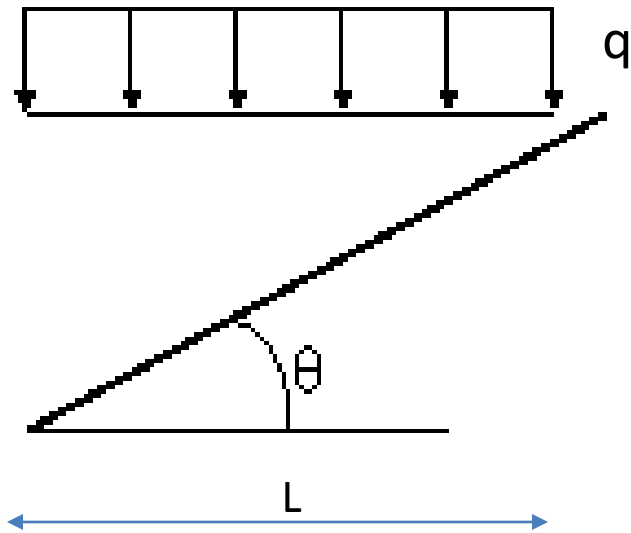

$$R = q * L$$

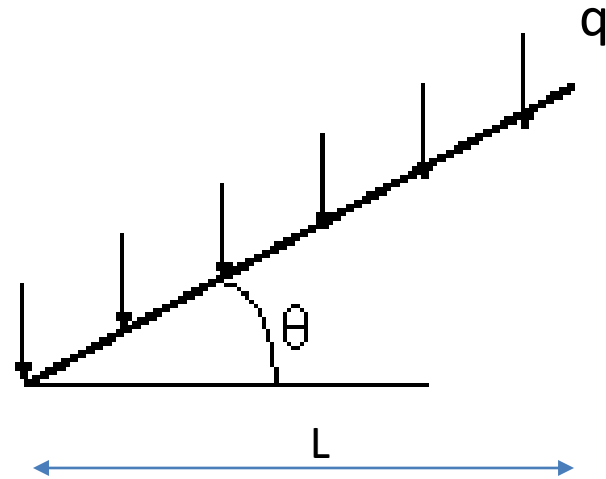

$$R = q * L / \cos(\theta)$$

Carga distribuida

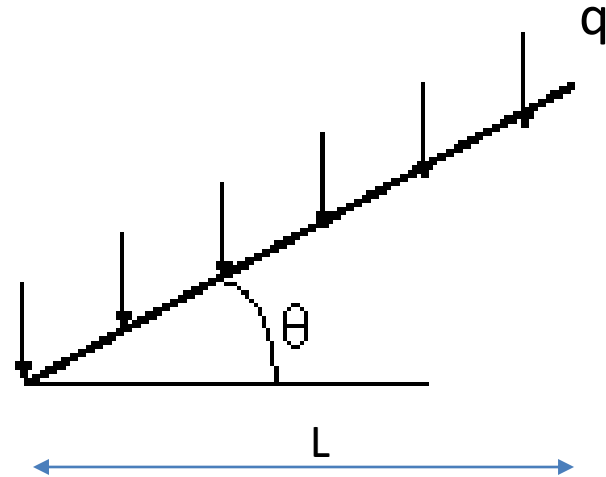
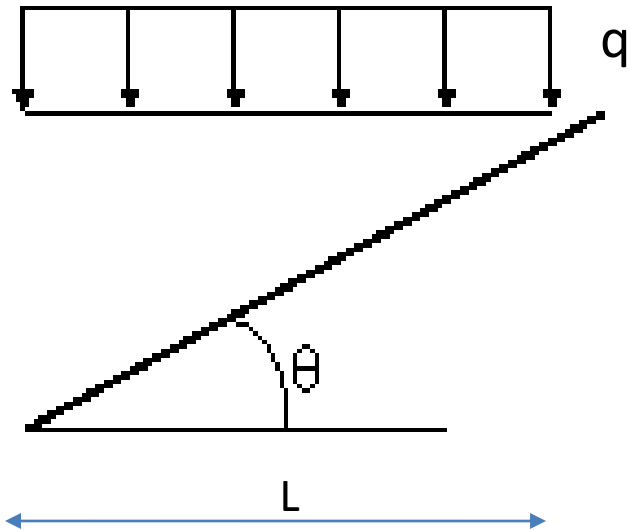

$$R = q * L / \cos(\theta)$$

