



Agencia de Cooperación Internacional del Japón



# Basic technology of ISDB-T

Nobuyuki Sato- JICA Expert

# Training curriculum contents

- ① Summary and characteristic of DTV and ISDB-T(12<sup>th</sup> .Mar)
- ② **Basic technology of ISDB-T (19<sup>th</sup> .Mar)**
  - ⇒ Lecture cancellation(26<sup>th</sup> .Mar)
- ③ Basic theory of ISDB-T (2<sup>nd</sup> .Apr)
- ④ Channel plan and Radio wave propagation (9<sup>th</sup> .Apr)
  - ⇒ Lecture cancellation(16<sup>th</sup> 23<sup>th</sup> 30<sup>th</sup> Apr)
- ⑤ NHK and its new technology(7<sup>th</sup> .May)
- ⑥ Systems of Transmitter and Receiver (14<sup>th</sup> .May)  
(including measurment)



# DTTB Implementation in Japan

# Schedule for DTTB

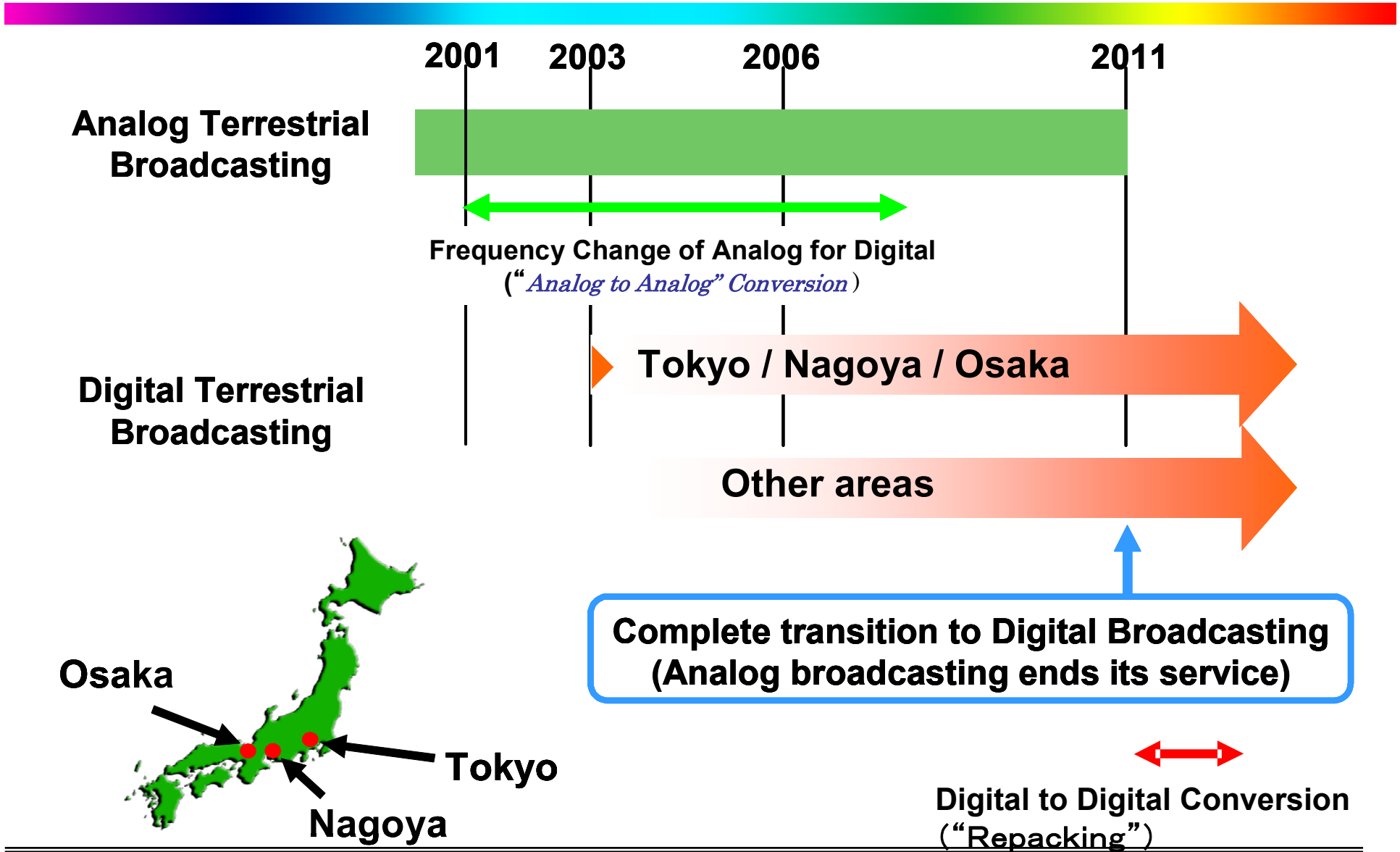

# Frequency Management

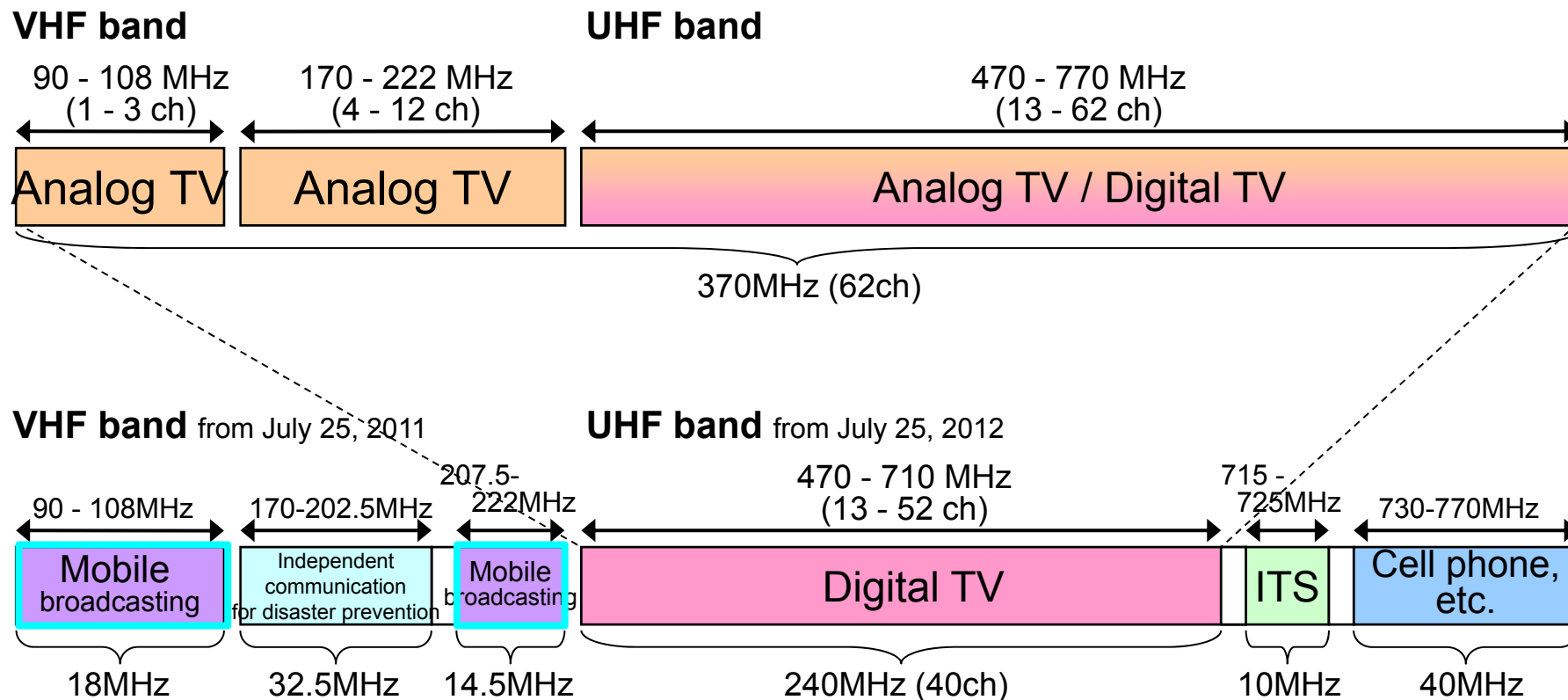

*VHF/UHF TV band Frequency planning in Japan*

# Effective Use of Radio Frequency

DTTB realizes more effective use of radio frequencies.  
New services will be introduced by using the reserved spectra.

Substantial mobile phone services

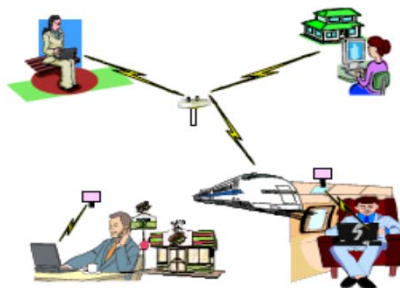

Realization of a safer road traffic society (ITS)

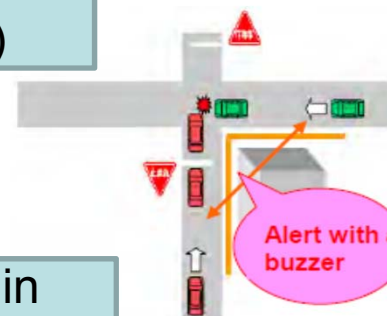

Applications in disasters



New service in broadcasting  
(Multimedia broadcasting)



# Analogue channel allocation

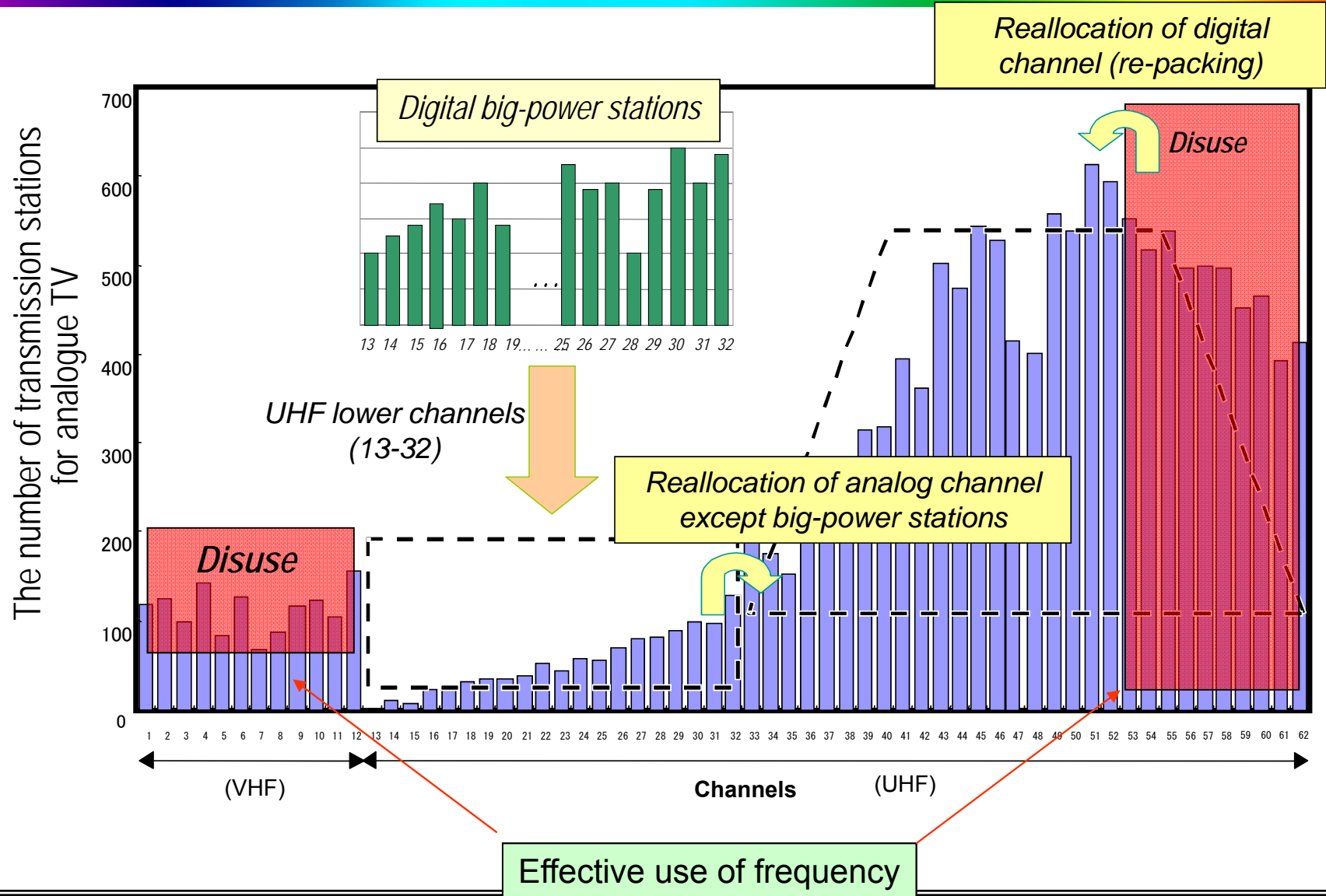

# Frequency Allocation Plan (UHF)

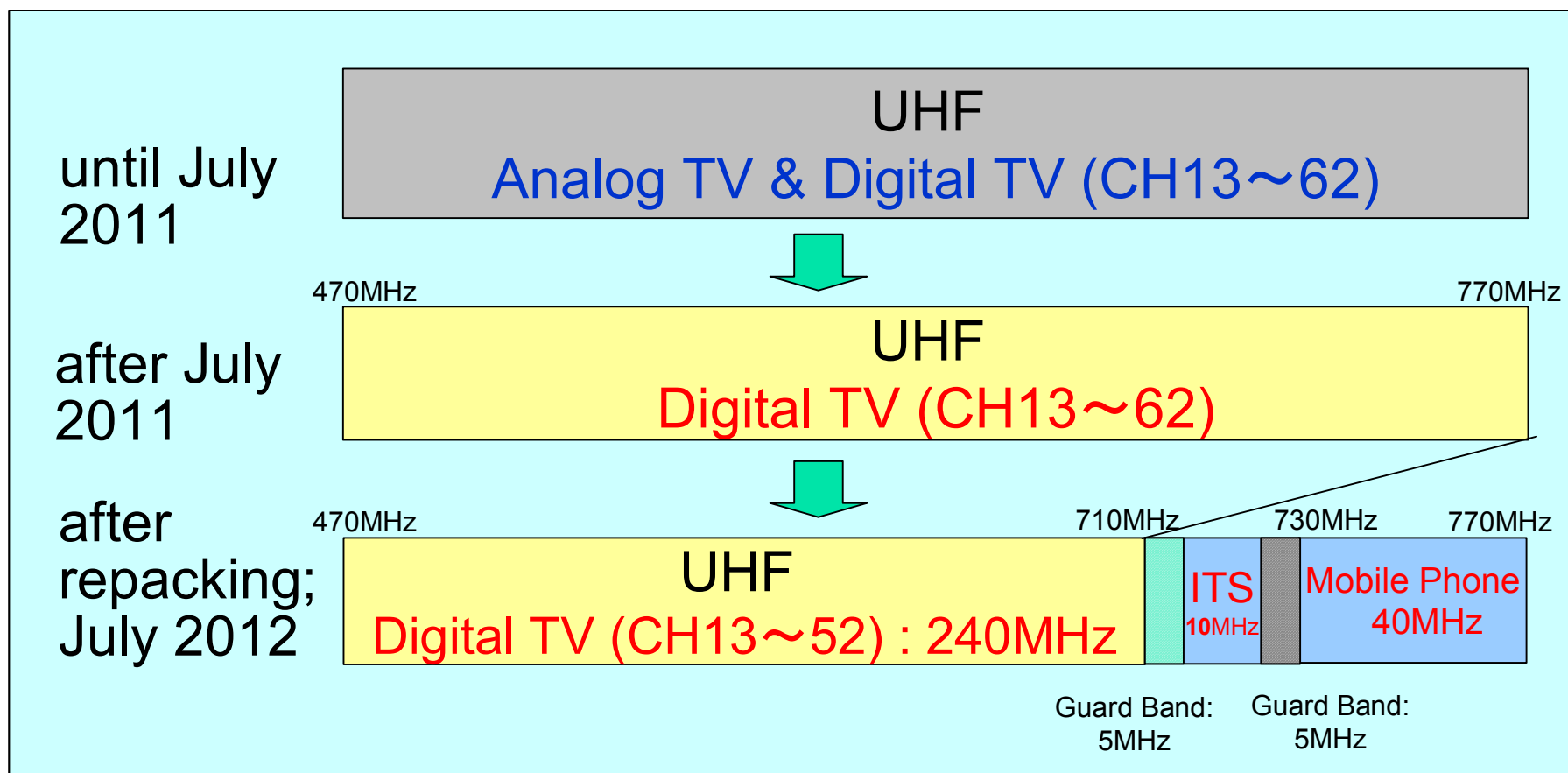



# Schedule for DTTB roll-out

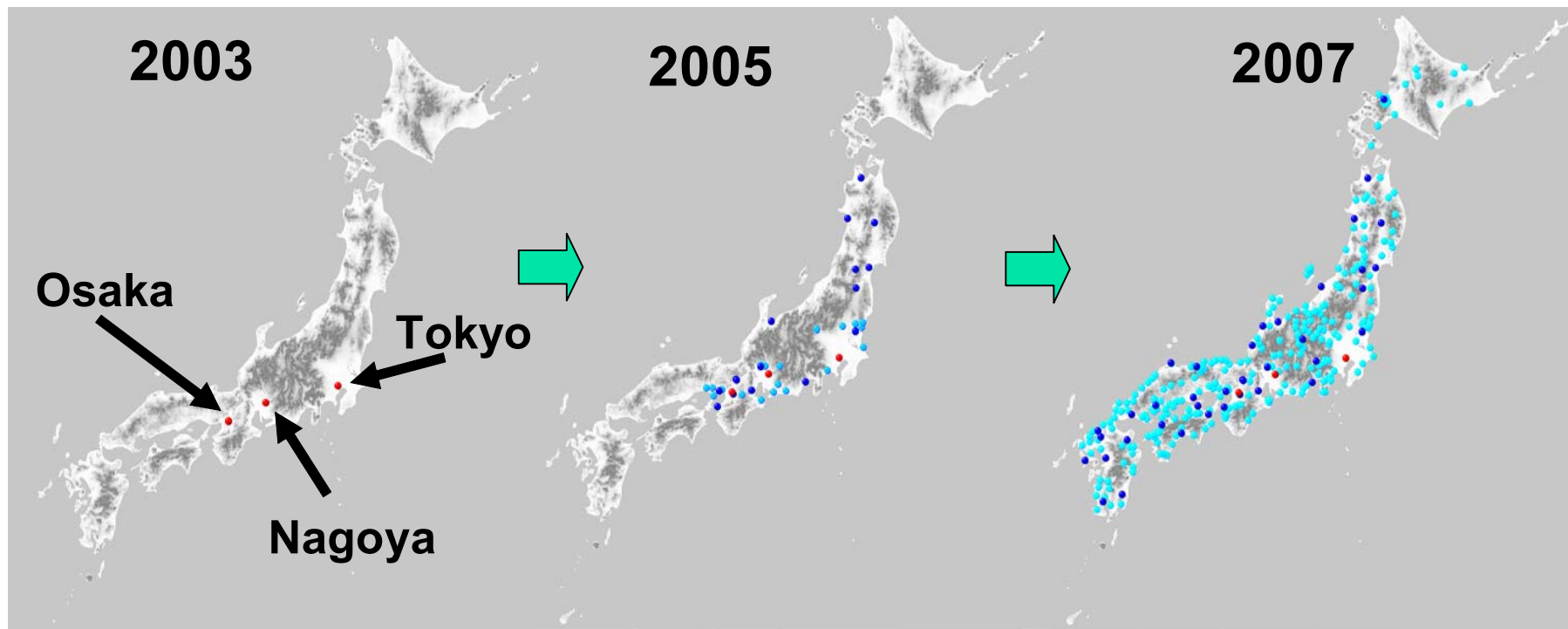

- **Expansion of DTTB coverage (number of households)**
  - 2003 25% (12 million) Commencement of DTTB
  - 2004 38% (18 million)
  - 2005 60% (28.4 million)
  - 2006 84% (39.5 million) Commencement in all prefectural capital cities
  - 2007 92% (43.3 million)

# Complete transition to DTTB by 2011

- Diffusion of DTTB signals throughout Japan
  - Requires **a large number of relay Tx-stations**.  
(NHK: around 4400, Commercial broadcasters: around 7000)

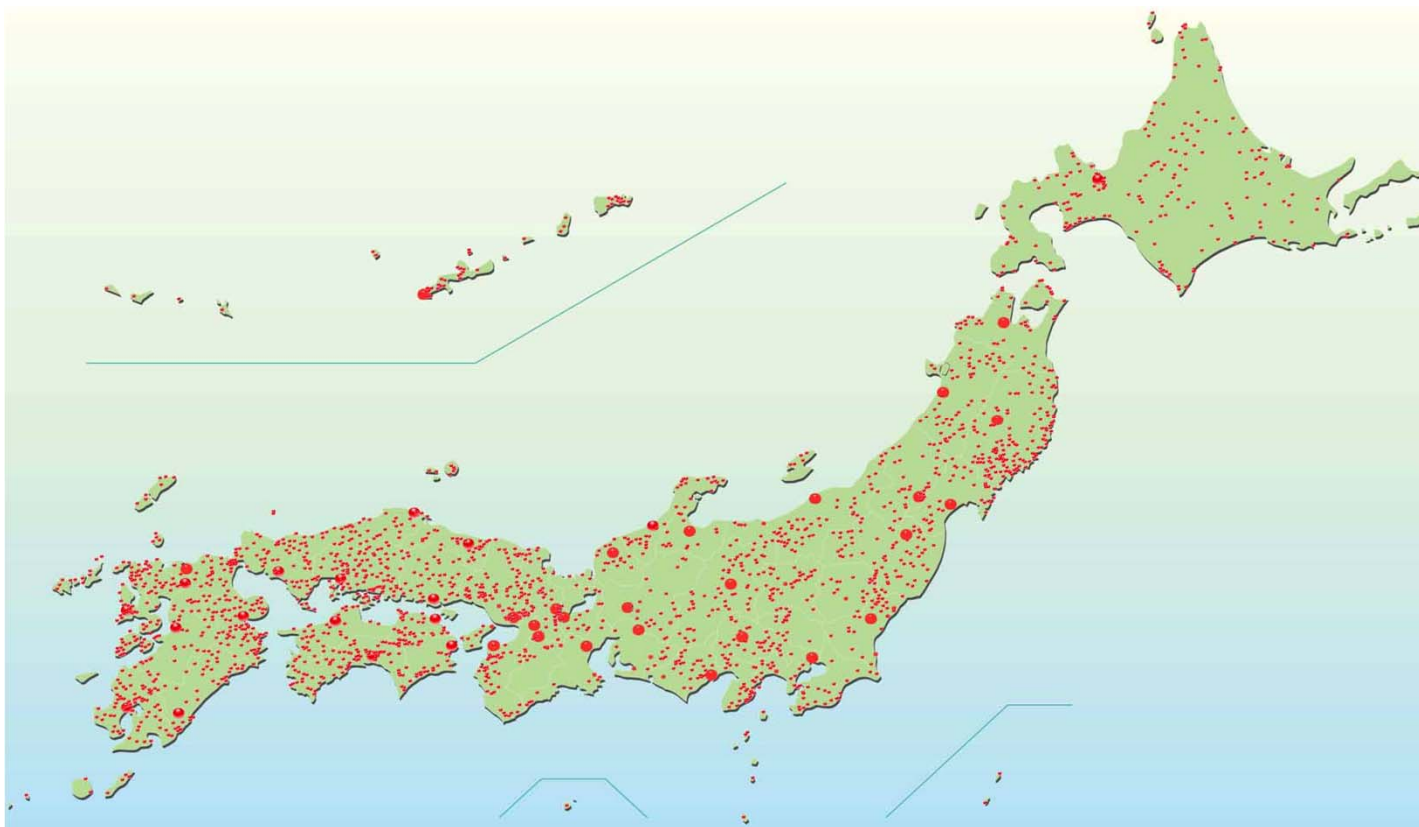

# Challenges on DTTB until 2011

- Broadcasters must build DTTB main and relay stations until 2010 (only for 8 years)
  - \* Analog TV network was constructed spending 30 years
- DTTB facilities are top priority for capital investment
- Simulcast
  - Must operate and maintain both analog and digital facilities
  - HD/SD simultaneous production system
    - VTR, Camera, . . . .
    - Aspect ratio (Conversion between SD and HD)

# Shipment of ISDB-T receivers in Japan

**More than 158 millions receivers** have been shipped  
**(by the end of March 2010)**

(Unit : thousand)

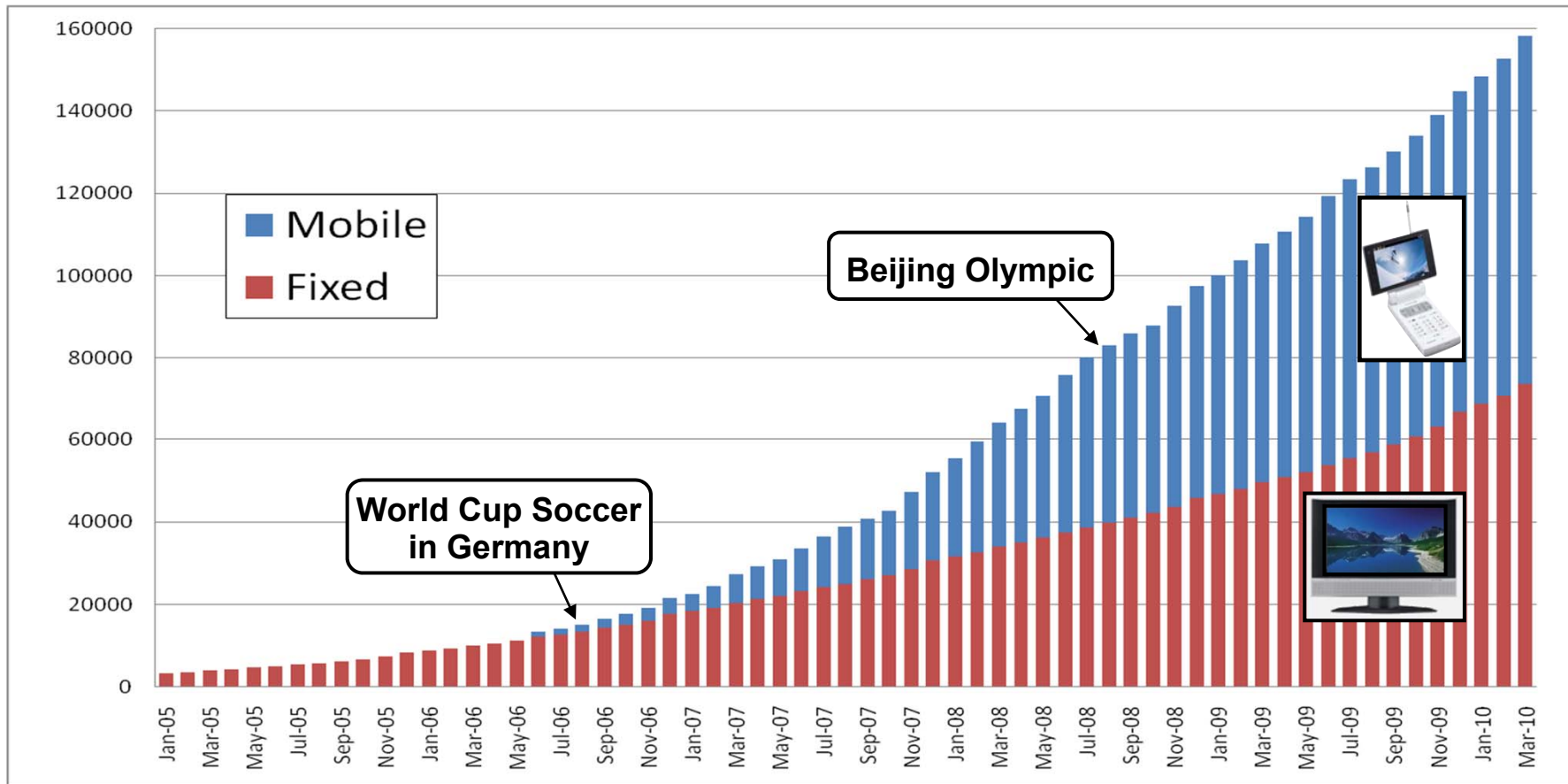

**84.6 millions mobile receivers** were shipped by the end of March 2010.

**73.6 millions fixed receivers** were shipped by the end of March 2010.



# Publicity and notice of analog TV termination

For the sake of customer's correct understanding of Analog TV set, the following *sticker* is put on the analog TV set.



Analog service will end by 2011. Digital tuner is needed to watch the Digital Service

Enhancement of viewers' understanding through broadcast programs

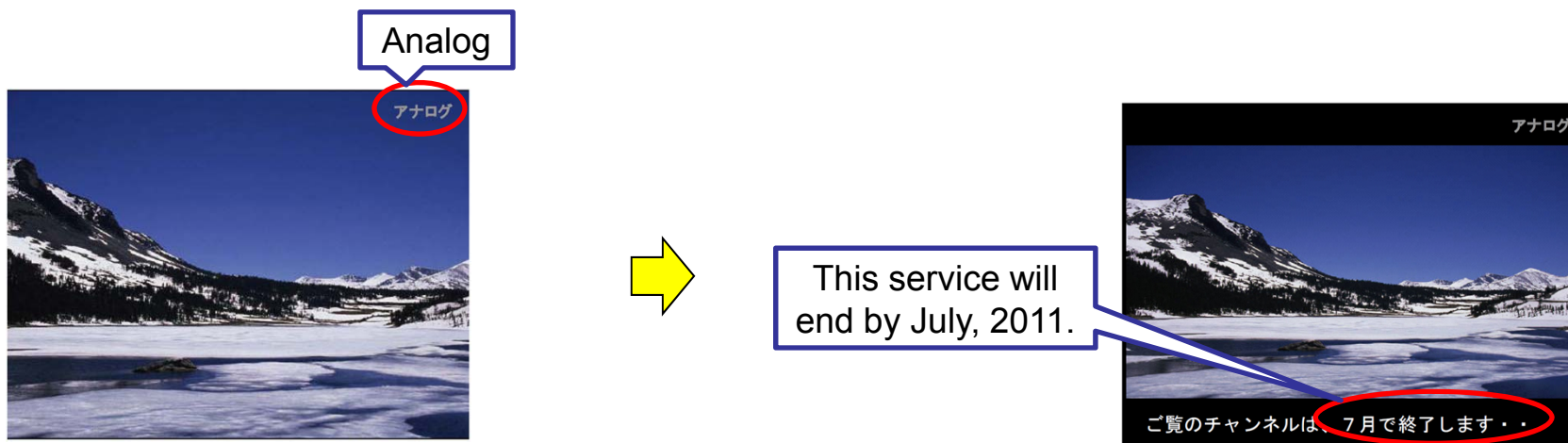

# Prestaciones del sistema ISDB-T

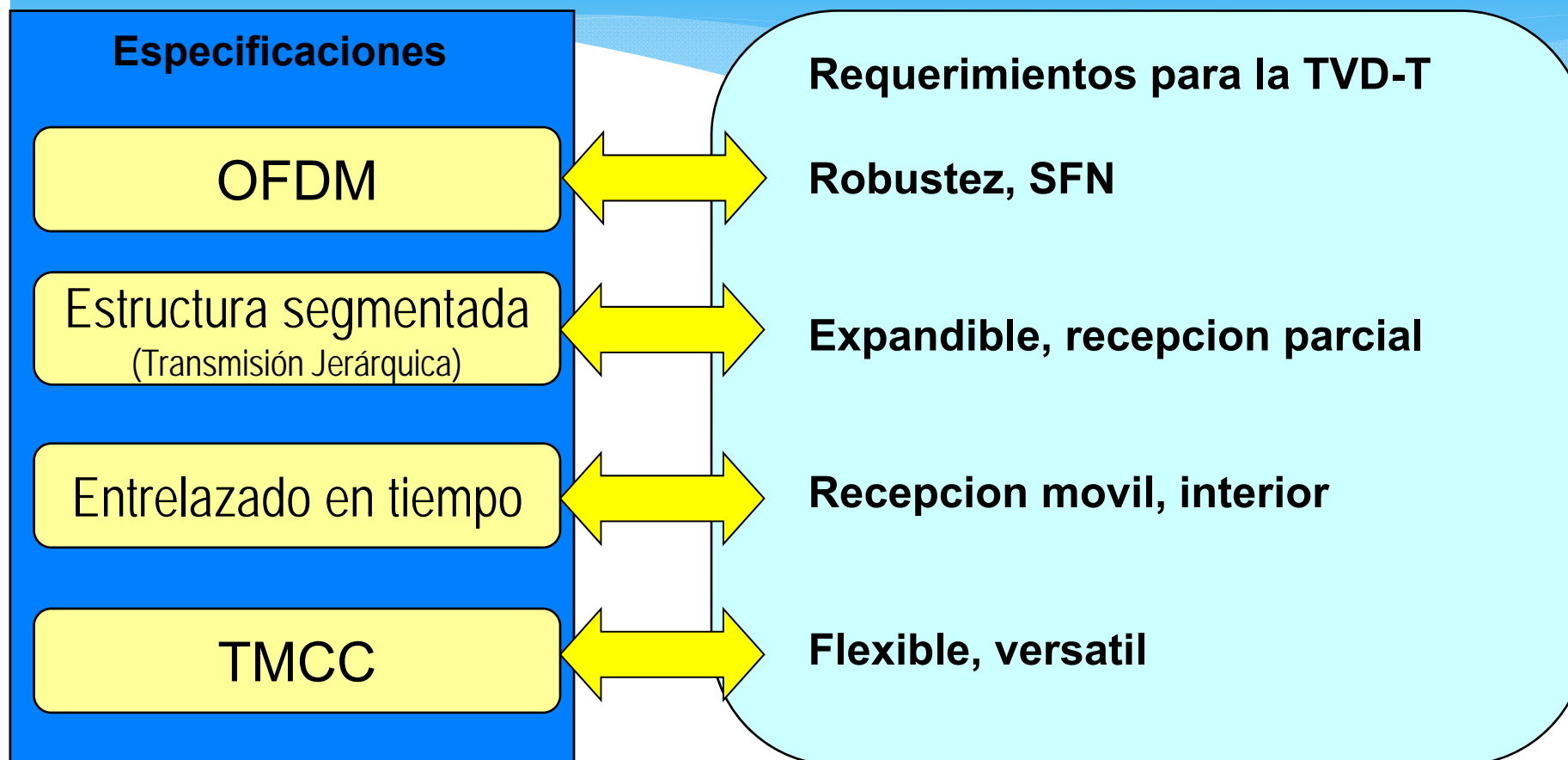

OFDM= Multiplexado por División de Frecuencias Ortogonales

TMCC= Control de Configuración de Transmisión y Multiplexado

# OFDM (Multiplexado por División en Frecuencias Ortogonales)

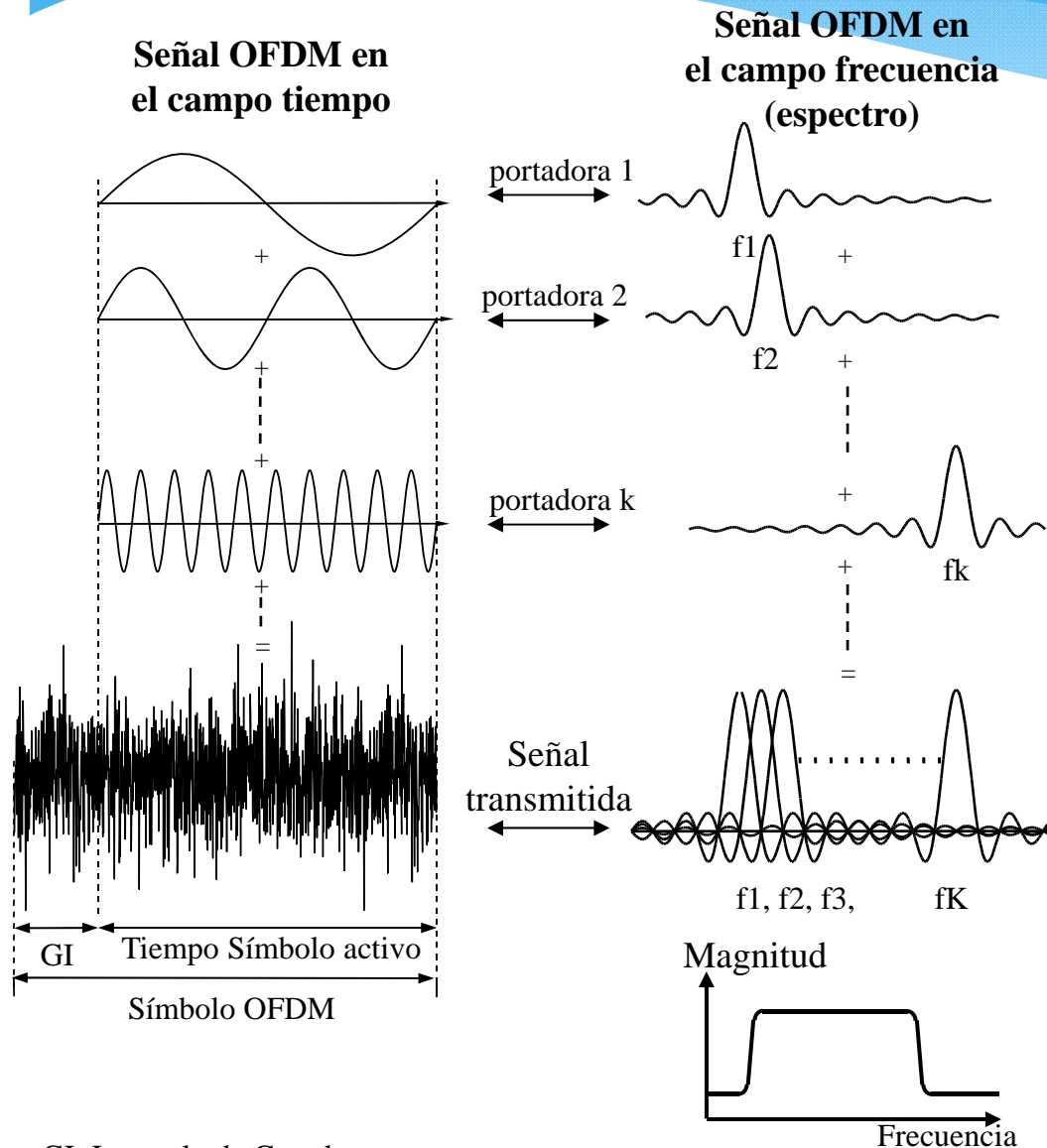

GI: Intervalo de Guarda

El multiplexado OFDM es:

- **Modulación multi-portadoras**
  - Mas de 5,000 portadoras en un canal de **TV**
  - Permite símbolos de mayor duración que la transmisión con portadora simple
- **Modulación que evita "multi-via"**
  - Símbolos de larga duración
  - Intervalo de Guarda

# Transmisión Jerárquica por OFDM segmentados (1)

El ISDB-T adopta la técnica de **transmisión jerárquica** por **OFDM**

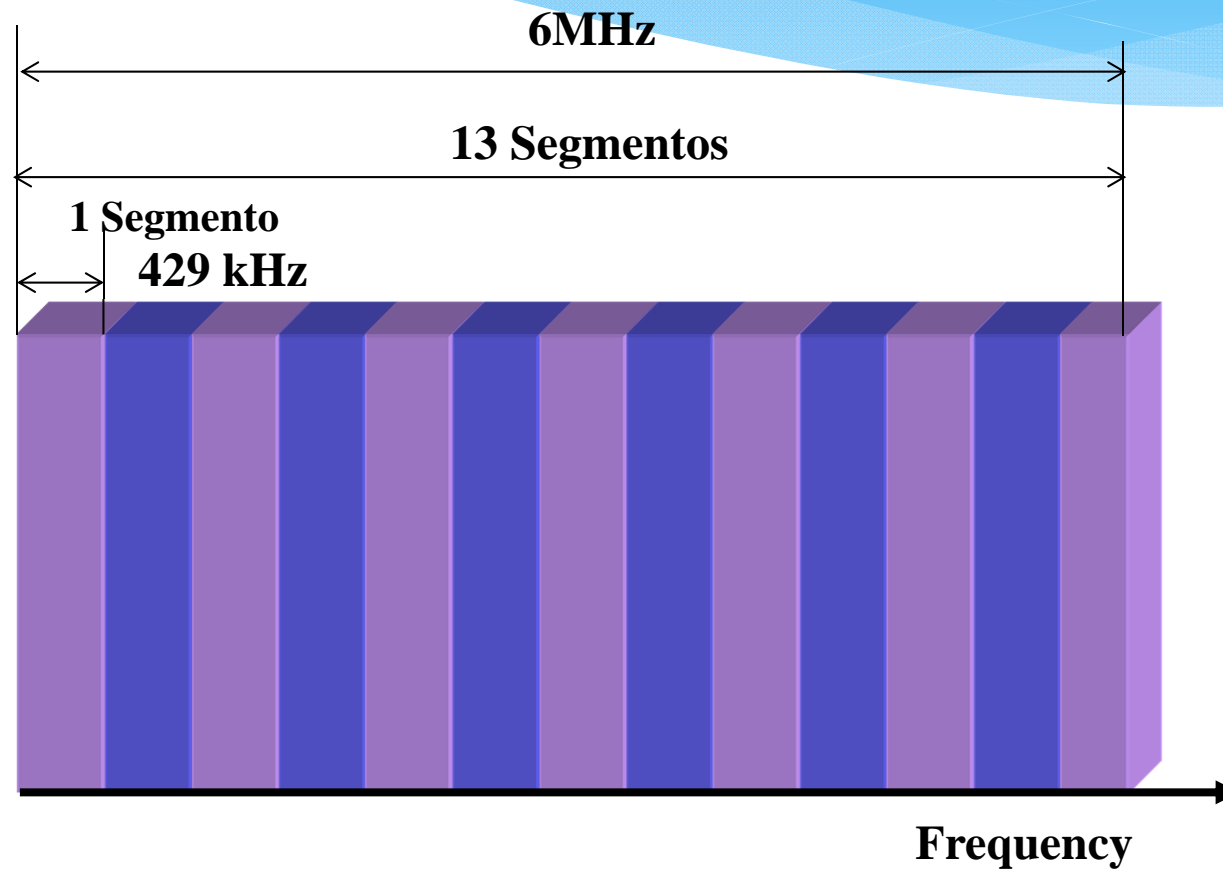



## Transmisión Jerárquica por OFDM segmentados (2)

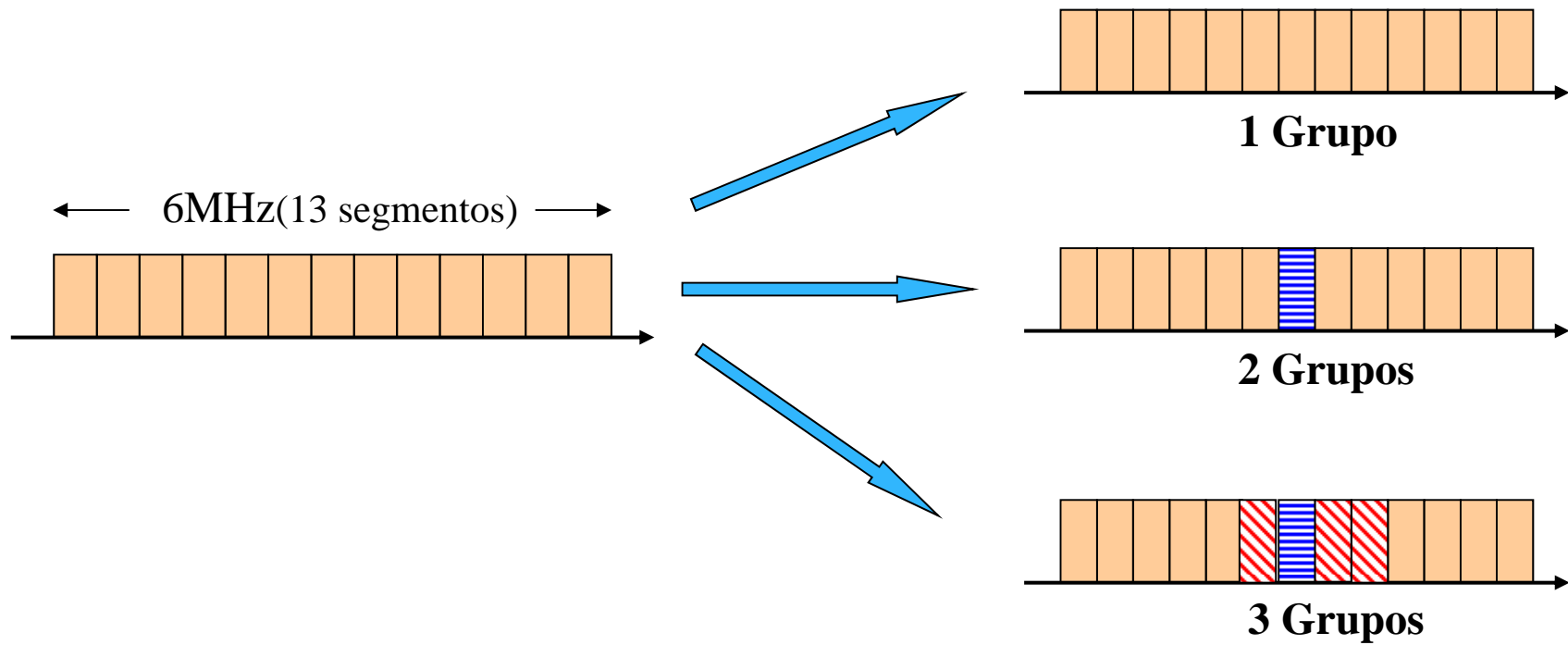

## Transmisión Jerárquica por OFDM segmentados (3)

La transmisión jerárquica se crea **modificando los parámetros** según los requerimientos de cada usuario.

\* **Modulación** : QPSK, 16QAM, 64QAM, (DQPSK)

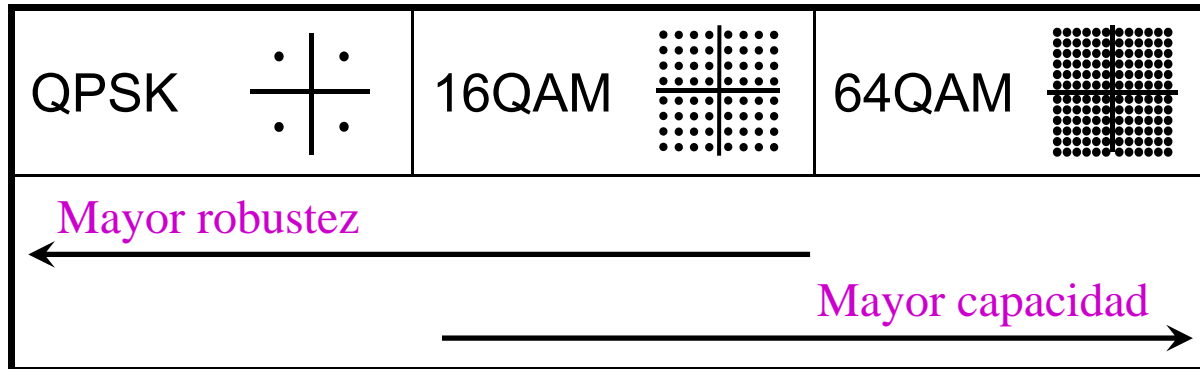

\* **Corrección de errores** : Índice de codificación convolucional (1/2 - 7/8)

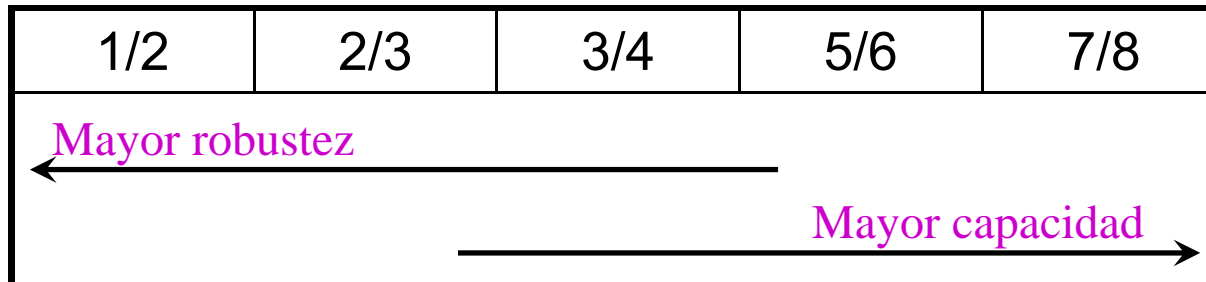

QPSK: modulación por desplazamiento de fase en cuadratura.

QAM: modulación de amplitud en cuadratura

# Transmisión Jerárquica por OFDM segmentados (4)

## Ejemplo

(transmisión en 2 capas)

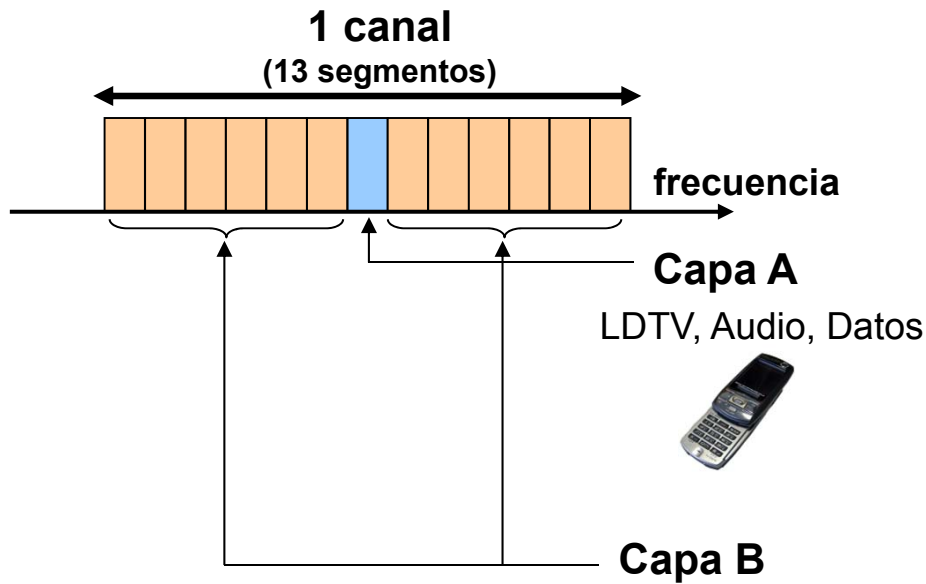

QPSK: modulación por desplazamiento de fase en cuadratura

QAM: modulación de amplitud en cuadratura

FEC: corrección de errores en avance

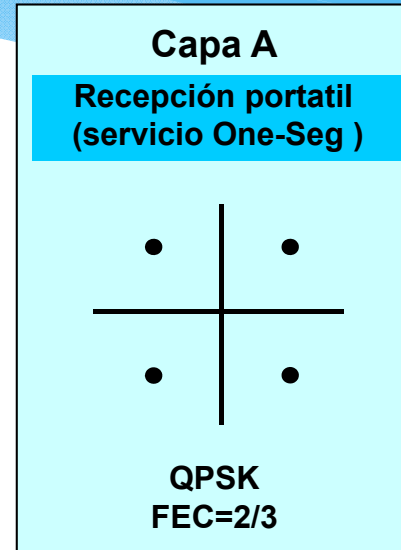
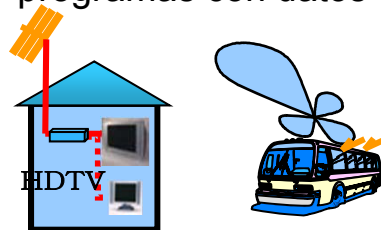

Para receptores portátiles

Transmisión robusta

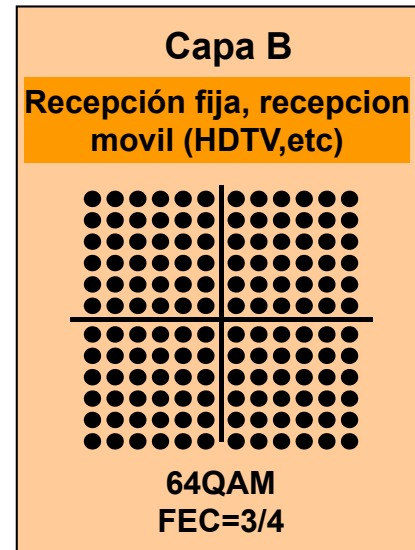

Para recepción HDTV o Multi-SDTV

Transmisión de alta capacidad

# Técnica del Entrelazado (1)

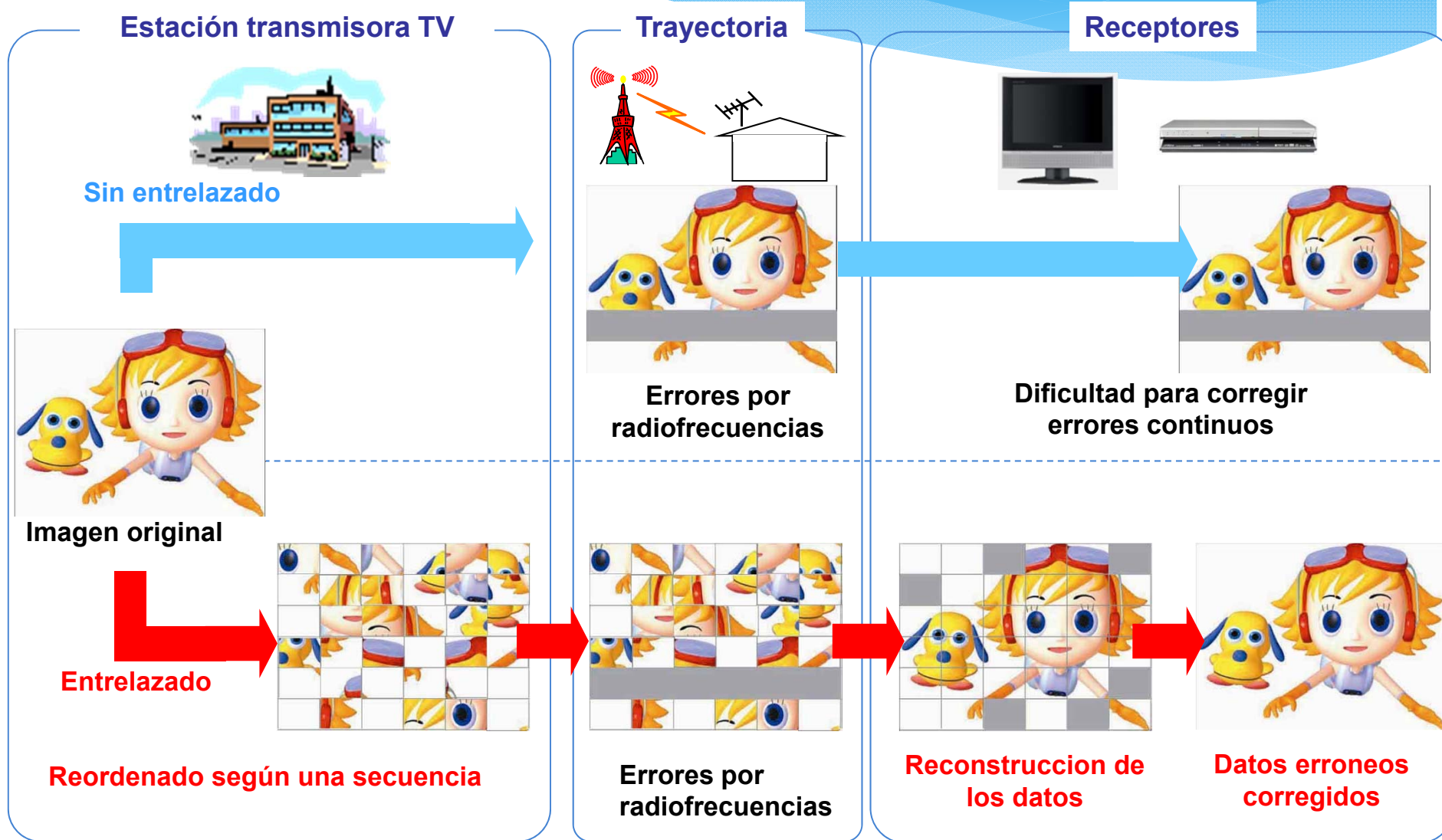

## Técnica del entrelazado (2) – efectos -

El entrelazado es una técnica fundamental en el sistema de transmisión.  
La corrección de errores es efectiva cuando la característica del ruido es aleatorio.  
El entrelazado busca aleatorizar la ráfaga de errores generada en la trayectoria.

Ante ráfagas de errores, la corrección FEC no funciona

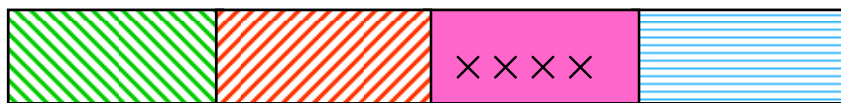

Ante errores Random, la corrección FEC funciona

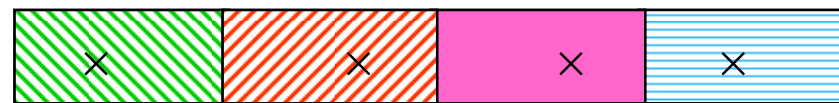

Transmision antes del Entrelazado



Transmision despues del Entrelazado

Entrelazado

**Burst error occurs at transmission path**



Recepcion despues del Des-entrelazado



Recepcion antes del Des-entrelazado

Des-entrelazado

## Técnica de entrelazado (3) – tipos y efectos

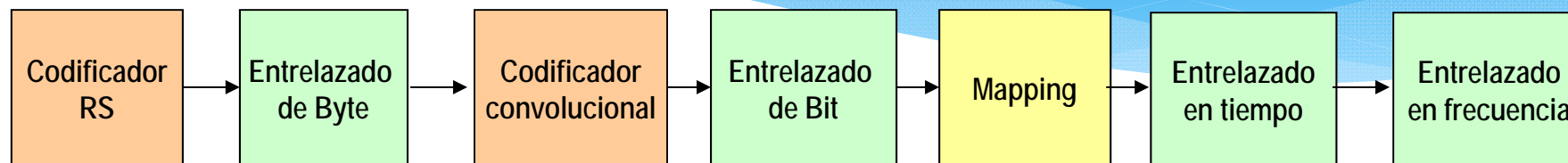

### Entrelazado de Byte

Está ubicado entre el codificador externo y el codificador interno. Aleatoriza los errores por ráfagas de la salida del **decodificador Viterbi**.

### Entrelazado de Bit

Está ubicado entre el codificador convolucional y el Mapping. Aleatoriza los errores de símbolos **antes del decodificador Viterbi**.

### Entrelazado en el Tiempo

Está ubicado a la salida del Mapping (modulación). Aleatoriza los errores por ráfagas en el campo tiempo, causados principalmente por ruidos por impulsos, desvanecimiento de la recepción de unidades móviles etc.

### Entrelazado de Frecuencia

Está ubicado a la salida del entrelazado en tiempo. Aleatoriza los errores por ráfaga en el Campo de frecuencia, causados principalmente por la transmisión multi-vía, interferencias etc.

# Intervalo de Guarda (1)

## Señal OFDM: forma de onda en el tiempo y espectrograma

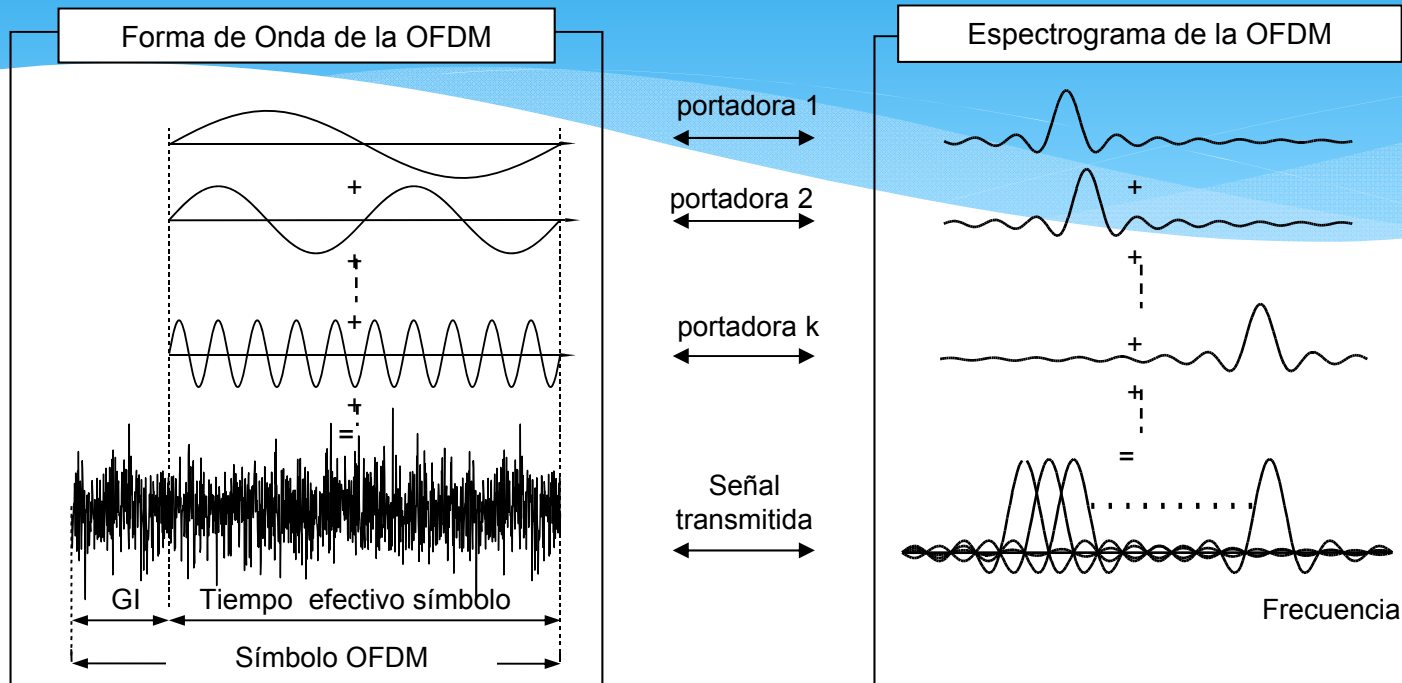

### Aplicación del Intervalo de Guarda

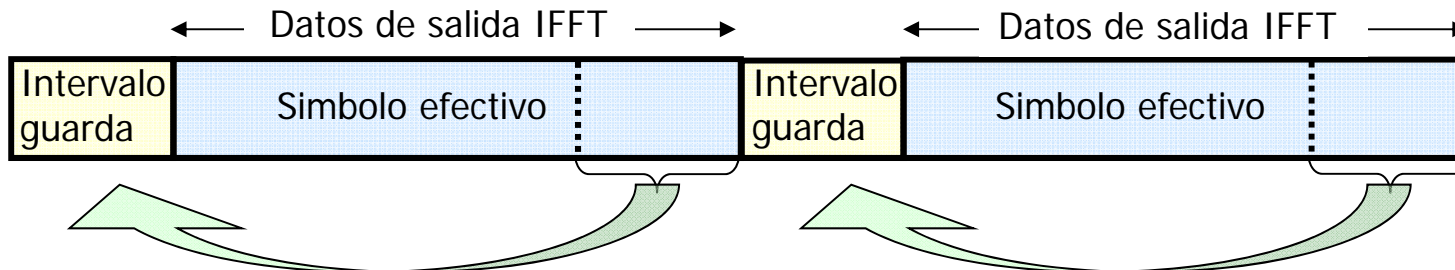

## Intervalo de Guarda (2) - Efectos

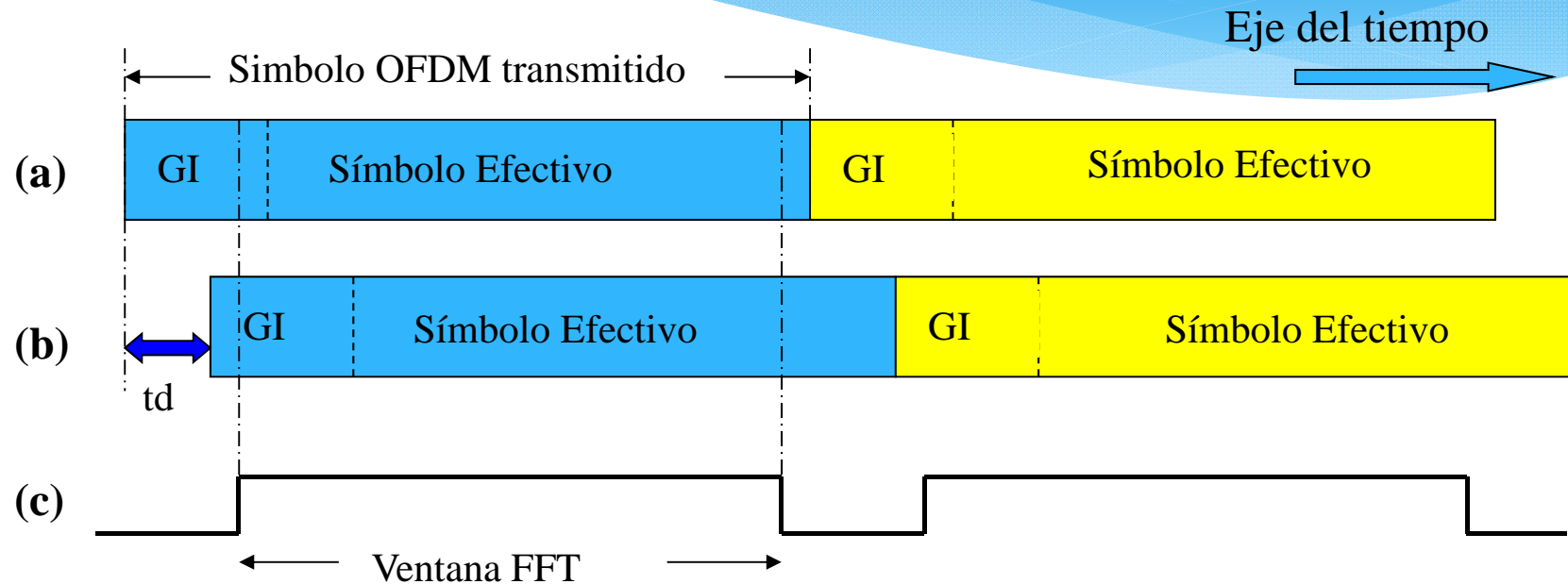

(a) : Onda directa del TX,      (b) : Onda reflejada (onda multi-vía)

GI: Intervalo de guarda,       $td$ : Retardo de onda multi-vía,      (c) Ventana FFT del receptor

La Ventana FFT del receptor recorta la señal en tramos de longitud  $T_s$  (símbolo efectivo). Esta señal entra a la FFT para demodular la señal OFDM. Si la Ventana FFT se ajusta de modo que queda dentro del intervalo del "símbolo OFDM transmitido", no se producirán "interferencias Inter-Símbolos" (ICI). Por ello, si el retardo de las ondas multi-vía no exceden el Intervalo de Guarda (GI), las interferencias por multi-vía prácticamente se anulan.



# Intervalo de Guarda (3) – Red de Frecuencia Unica RFU-

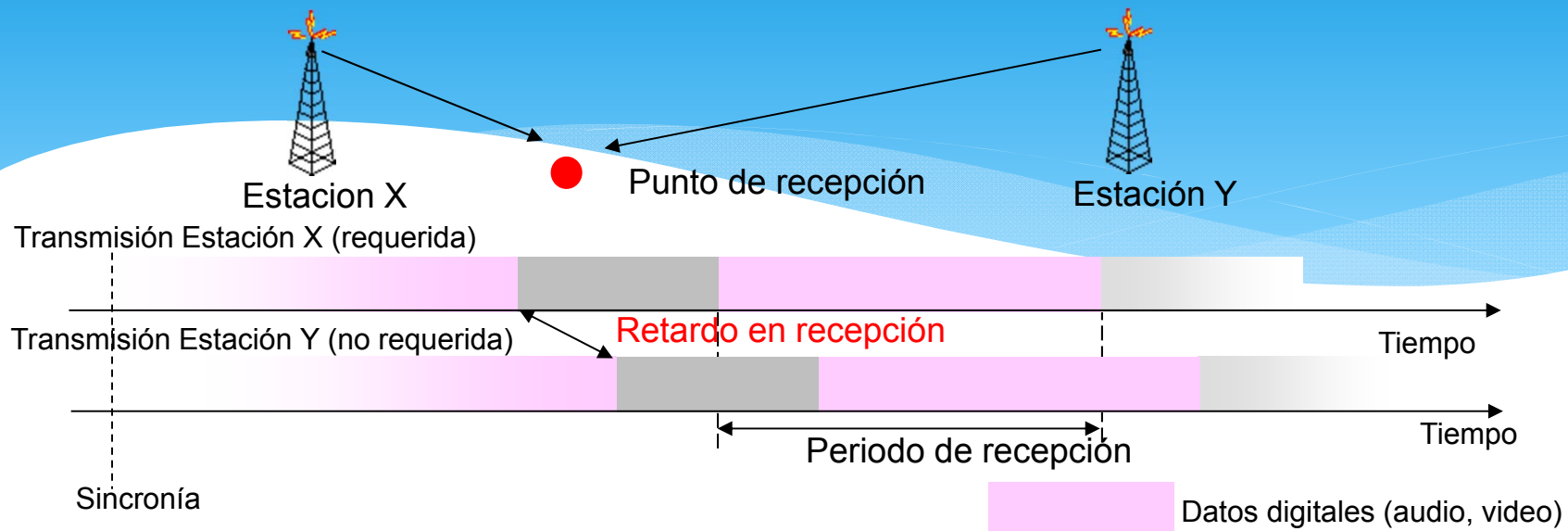

Conformación de una Red de Frecuencia Única

Racionalización del uso de las radio-frecuencias

En el Japón, sobre un total de 10.000 estaciones se conformaron unos 40 canales.

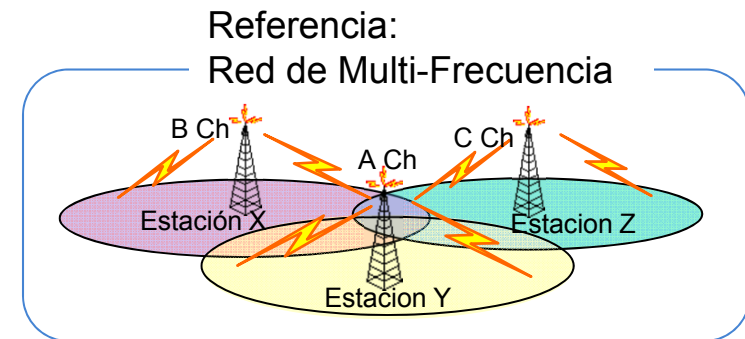
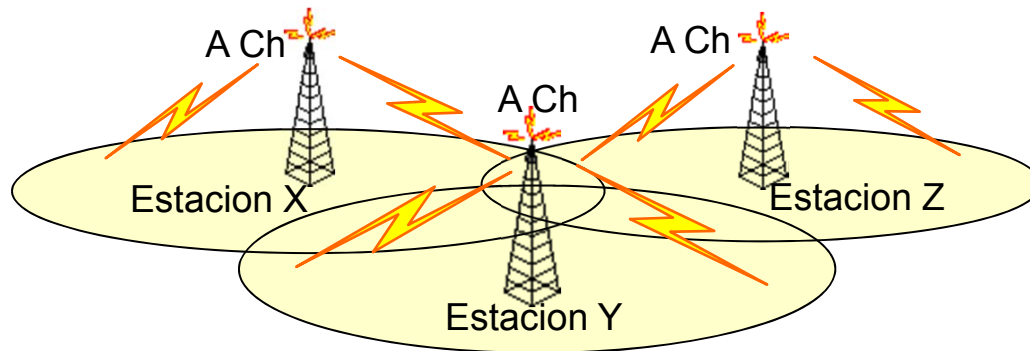

# Diagrama Funcional en bloque del ISDB-T

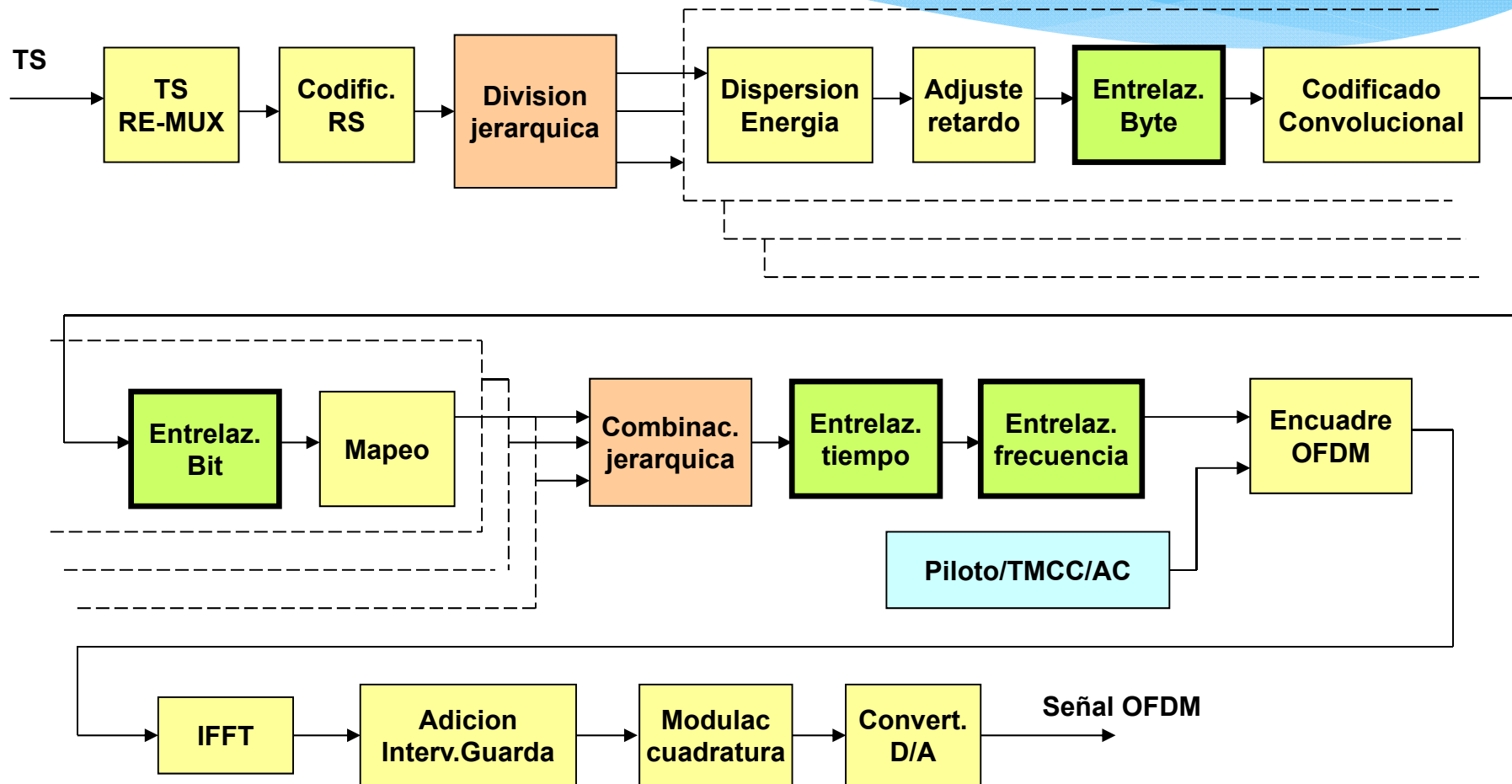

# Parametros del ISDB-T (AB: 6MHz)

<b>Modo ISDB-T</b>	<b>Mode 1 (2k)</b>	<b>Mode 2 (4k)</b>	<b>Mode 3 (8k)</b>
<b>Cant. segmentos OFDM</b>	<b>13</b>		
<b>Ancho de banda utilizable</b>	<b>5.575MHz</b>	<b>5.573MHz</b>	<b>5.572MHz</b>
<b>Espaciado portadoras</b>	<b>3.968kHz</b>	<b>1.984kHz</b>	<b>0.992kHz</b>
<b>Total portadoras</b>	<b>1405</b>	<b>2809</b>	<b>5617</b>
<b>Modulación</b>	<b>QPSK , 16QAM , 64QAM , DQPSK</b>		
<b>Nro simbolos / cuadro</b>	<b>204</b>		
<b>Duracion simbolo activo</b>	<b>252μ s</b>	<b>504μ s</b>	<b>1.008ms</b>
<b>Intervalo de Guarda</b>	<b>1/4 , 1/8 , 1/16 , 1/32 del t. simbolo activo</b>		
<b>Codificacion interna</b>	<b>Codif. Convolutcional (1/2 , 2/3 , 3/4 , 5/6 , 7/8)</b>		
<b>Codificacion externa</b>	<b>RS (204,188)</b>		
<b>Entrelazado en tiempo</b>	<b>0 ~ 0.5s</b>		
<b>Tasa de bits utilizable</b>	<b>3.651Mbps ~ 23.234Mbps</b>		

# Tecnología de RFU

- La tecnología de RFU es una de las prestaciones del ISDB-T.
- La tecnología de RFU se aplica para ahorrar frecuencias.

★RFU: Red de Frecuencia Unica

- ***La red de transmisión puede construirse con RFU o con multiples frecuencias.***
- ***La red RFU es particularmente ventajosa cuando escasean las frecuencias libres.***

# Qué es una red RFU?

## Sistema Analogico

### Red analogica

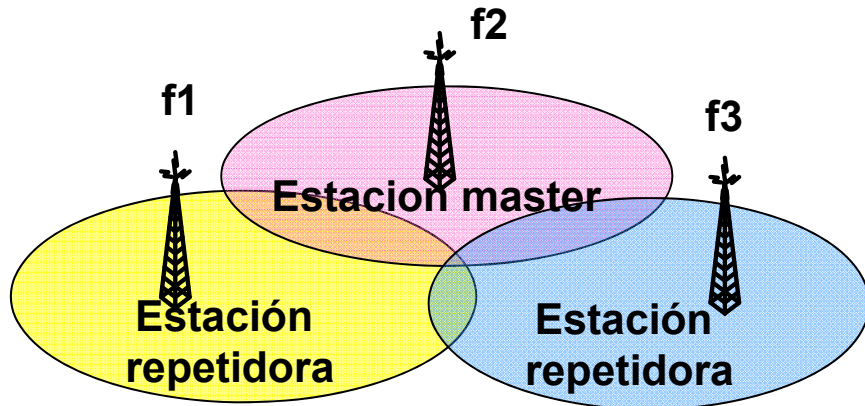

f1, f2, f3 ⇒ Canales de frecuencia

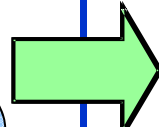

## Sistema Digital

### Red Frecuencia Unica

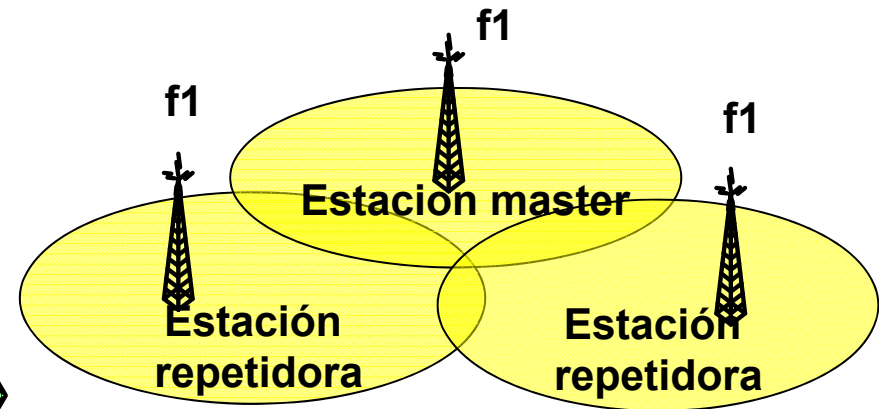

### SFN and MFN Network

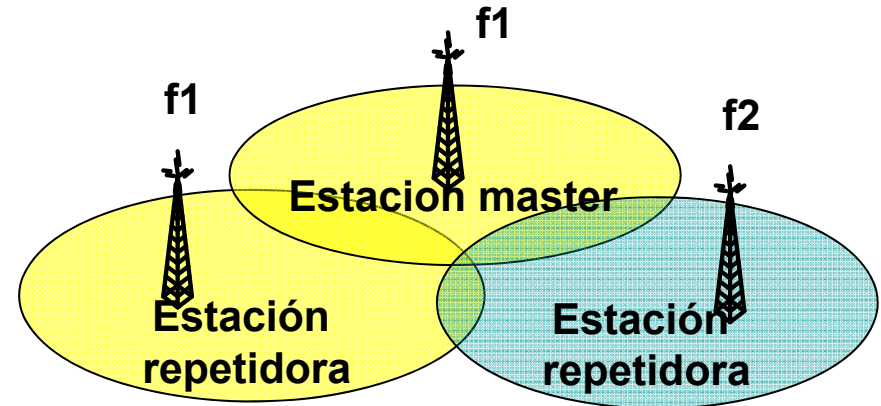

# Condiciones para conformar una RFU

- **Sincronización de la red de transmisión**

En el punto de recepción, los retardos entre 2 o mas señales deben ser igual o menores al Intervalo de Guarda. ( $GI^*$ ).

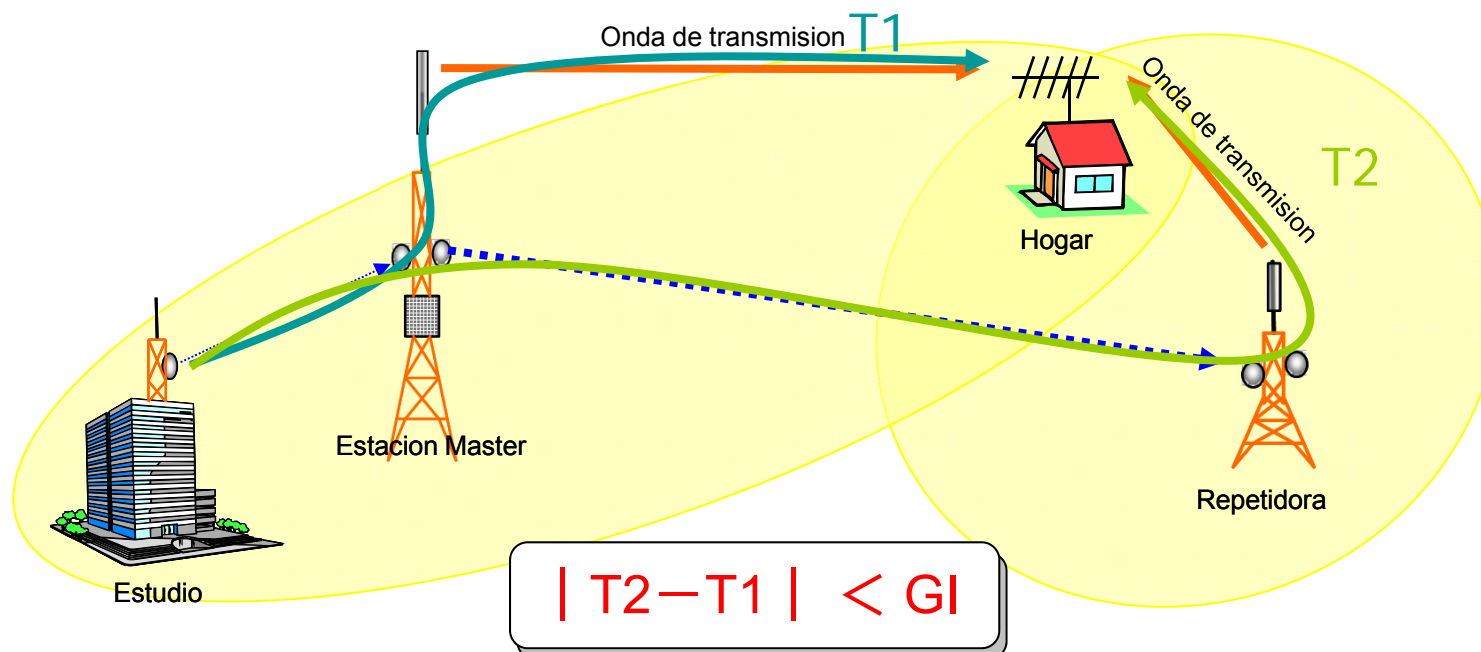

# Condiciones para conformar una RFU

Si:  $|T2 - T1| \geq GI$

$D/U \geq$  tasa de protección... **OK**  
 $D/U <$  tasa de protección... **(X)**

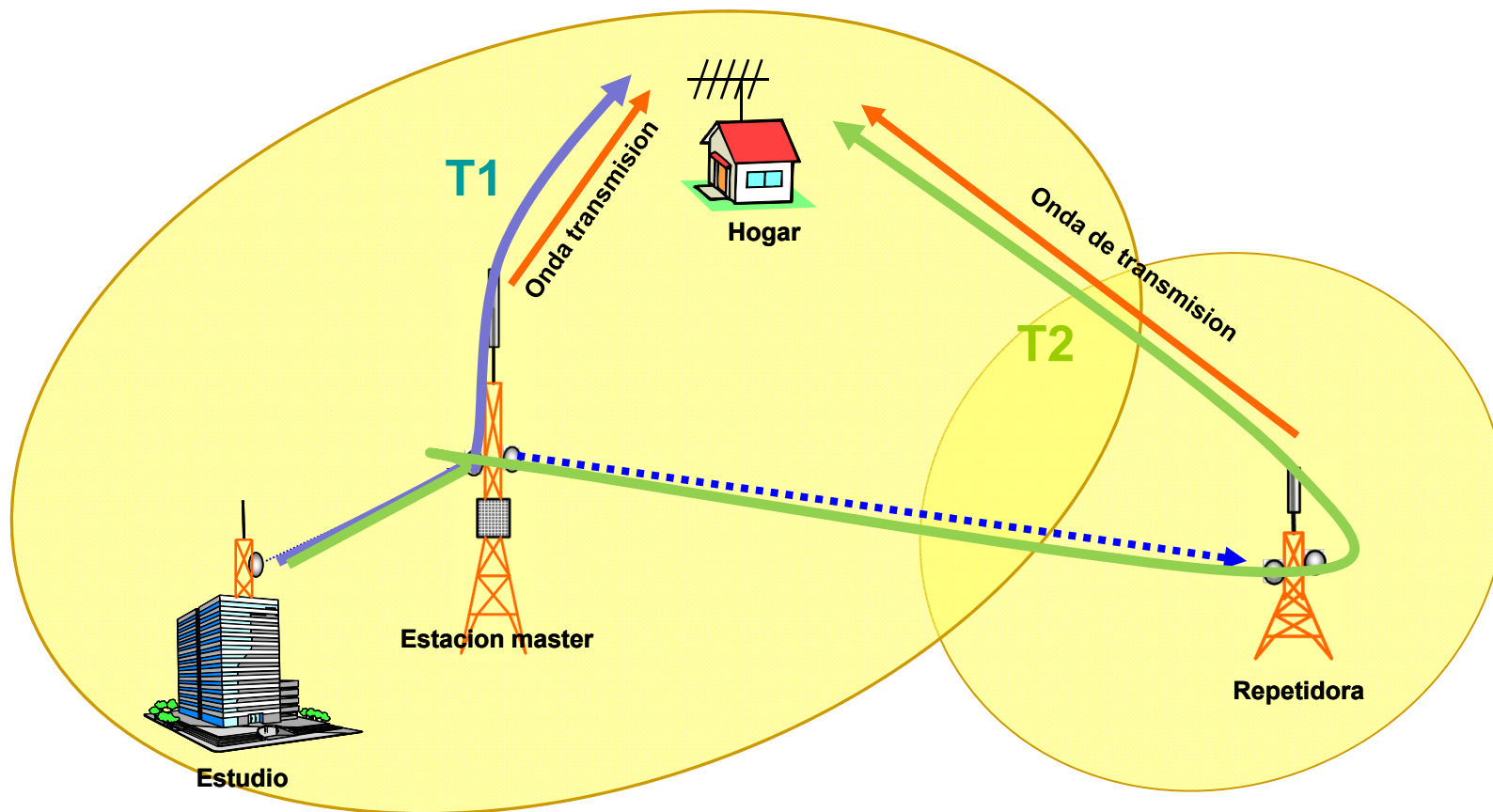

# SFN image in URUGUAY 1





# SFN image in URUGUAY 2

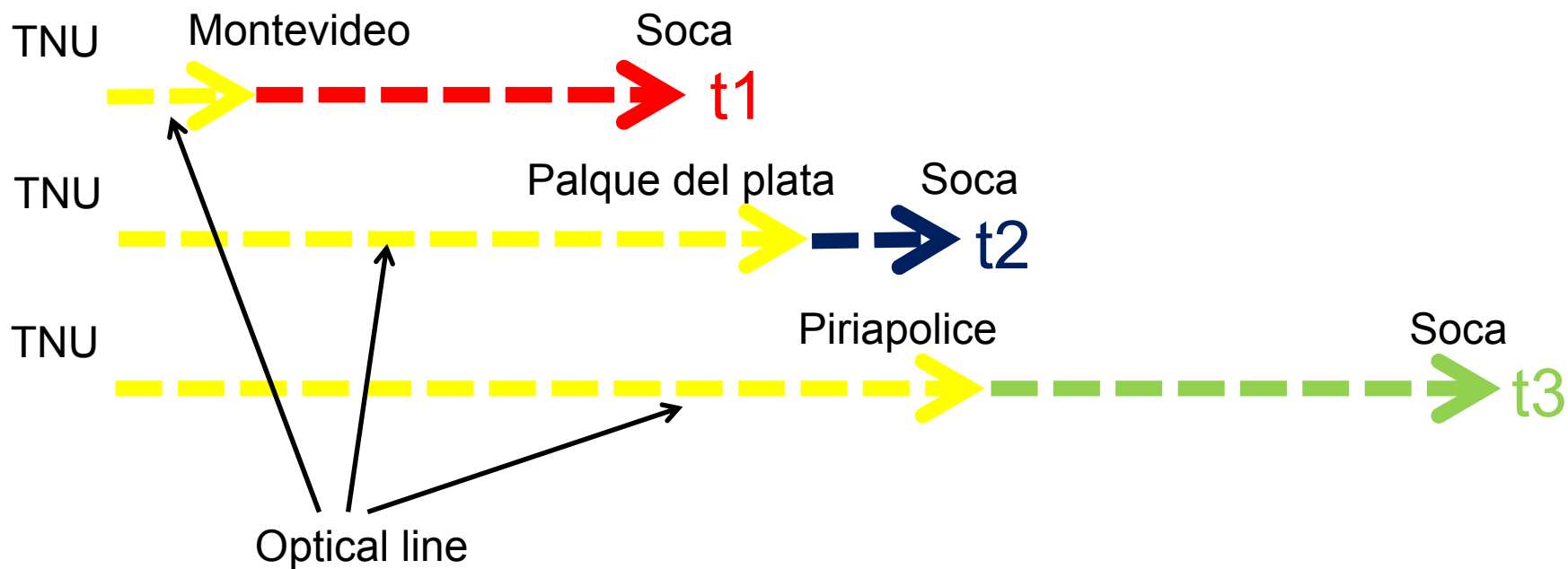

# SFN image in URUGUAY 3

Case1 : Desire wave = Montevideo

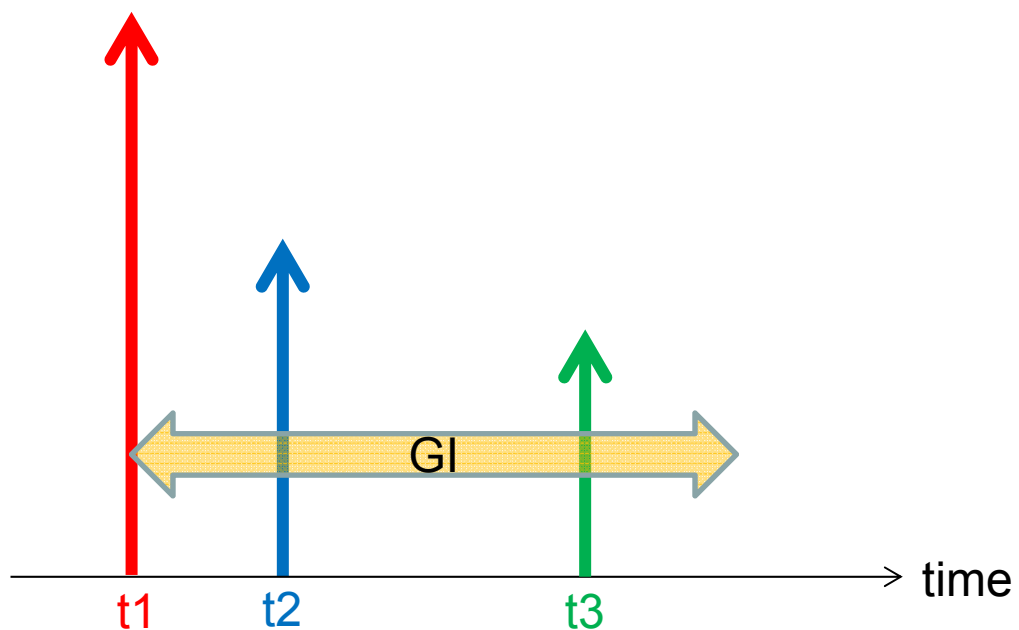

$$t_3 - t_1 < GI(126\mu s)$$

→ OK!!

# SFN image in URUGUAY 4

Case1 : Desire wave = Montevideo

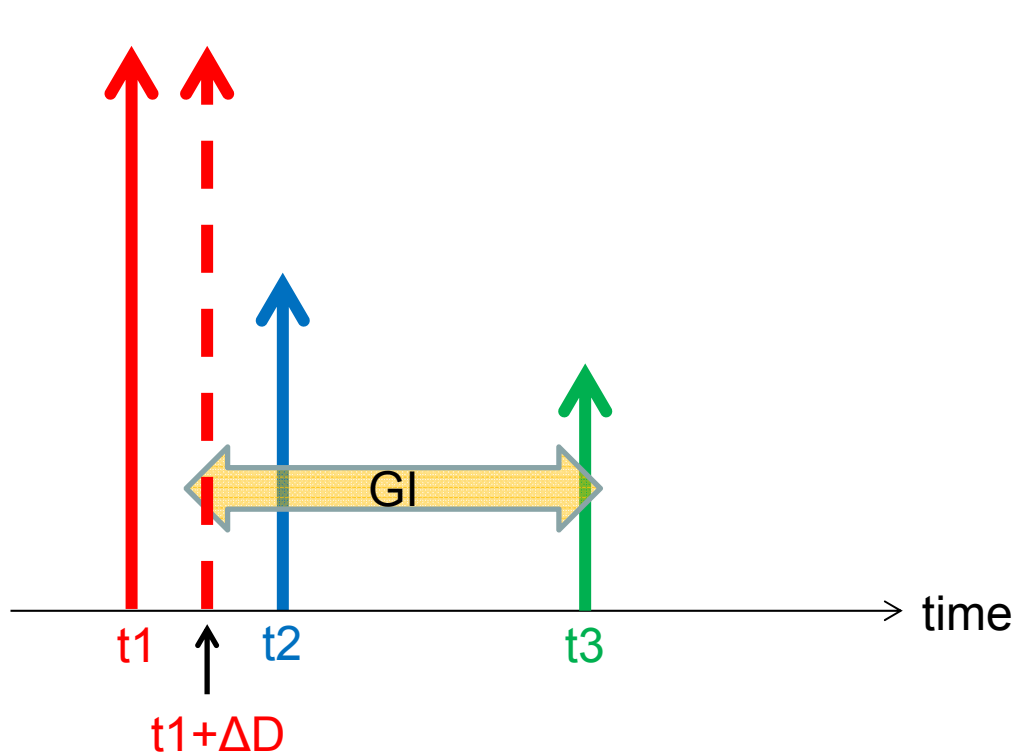

$$t_3 - t_1 > GI(126\mu s)$$

→ NG!!

$$t_3 - t_1 - \Delta D < GI(126\mu s)$$

→ OK!!

# SFN image in URUGUAY 5

Case1 : Desire wave = Parque del plata

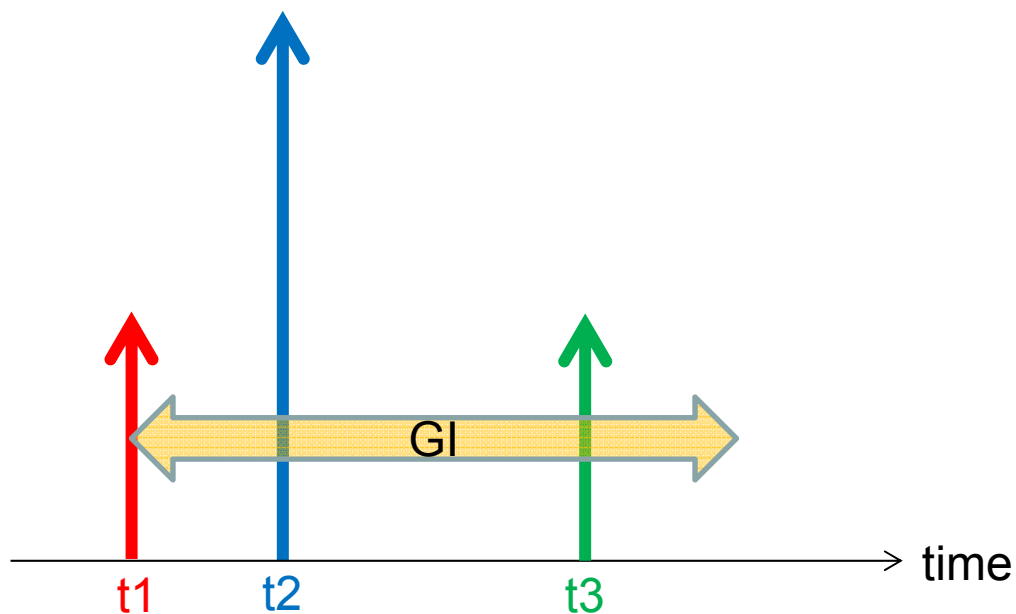

$$t_3 - t_1 < GI(126\mu s)$$

→ OK!!

# SFN image in URUGUAY 6

Case1 : Desire wave = Parque del plata

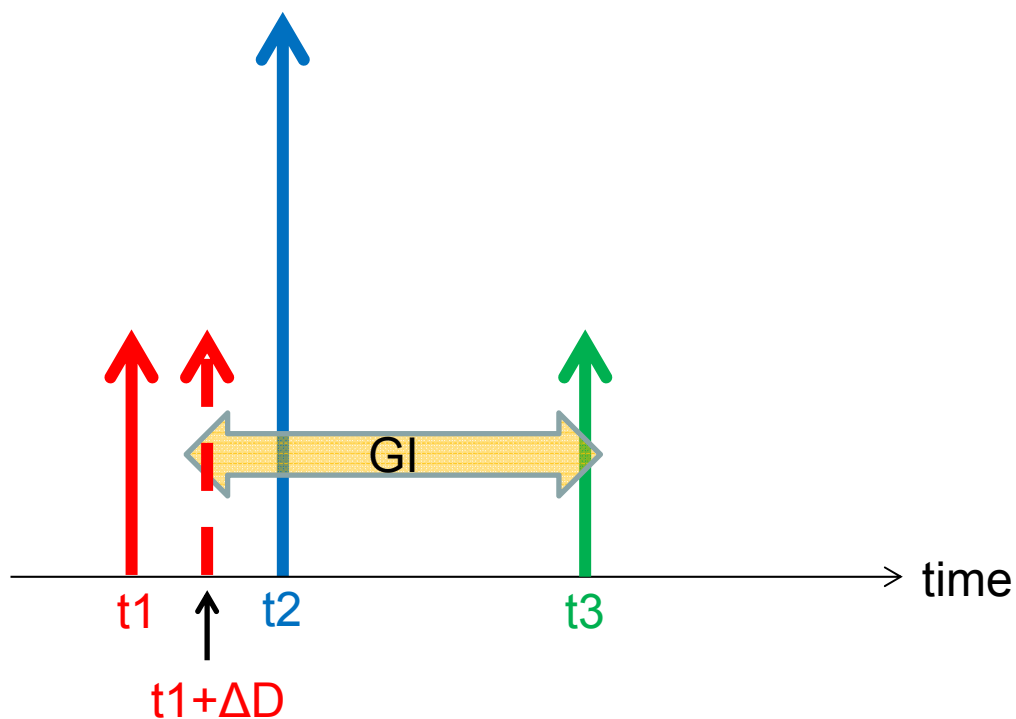

$$t_3 - t_1 > GI(126\mu s)$$

→ NG!!

$$t_3 - t_1 - \Delta D < GI(126\mu s)$$

→ OK!!

# Homework 1

- ① Explain the difference between ISDB-T and ISDB-Tb  
(Reference ARIB-Standard B-31, ABNT-NBR15601)
  
- ② In Mode3 , how many carriers per one segment.



Agencia de Cooperación Internacional del Japón



# Homework2

③ When transmitting at the same frequency from the location of the three different (A, B, C), interference occurs at the point D. The transmission time between studio and A, B, C are 300 $\mu$ s, 500 $\mu$ s, 800 $\mu$ s. The distance between D and A, B, C are 60km, 27km, 9km. How do you eliminate the interference?

④ What do you expect to Digital television in Uruguay?



Agencia de Cooperación Internacional del Japón



# Muchísimas gracias

Next lecture 2<sup>nd</sup> April