



Hands-on IA-Redes

Rafael Pasquini
FACOM/UFU
2024

Explain this image



Data is essential for accurate models



Networking is a complex scenario!



Different Administrative Domains



Cloud
Thousands of Data Centers

Fog
Millions of Nodes

Edge
Billions of Devices

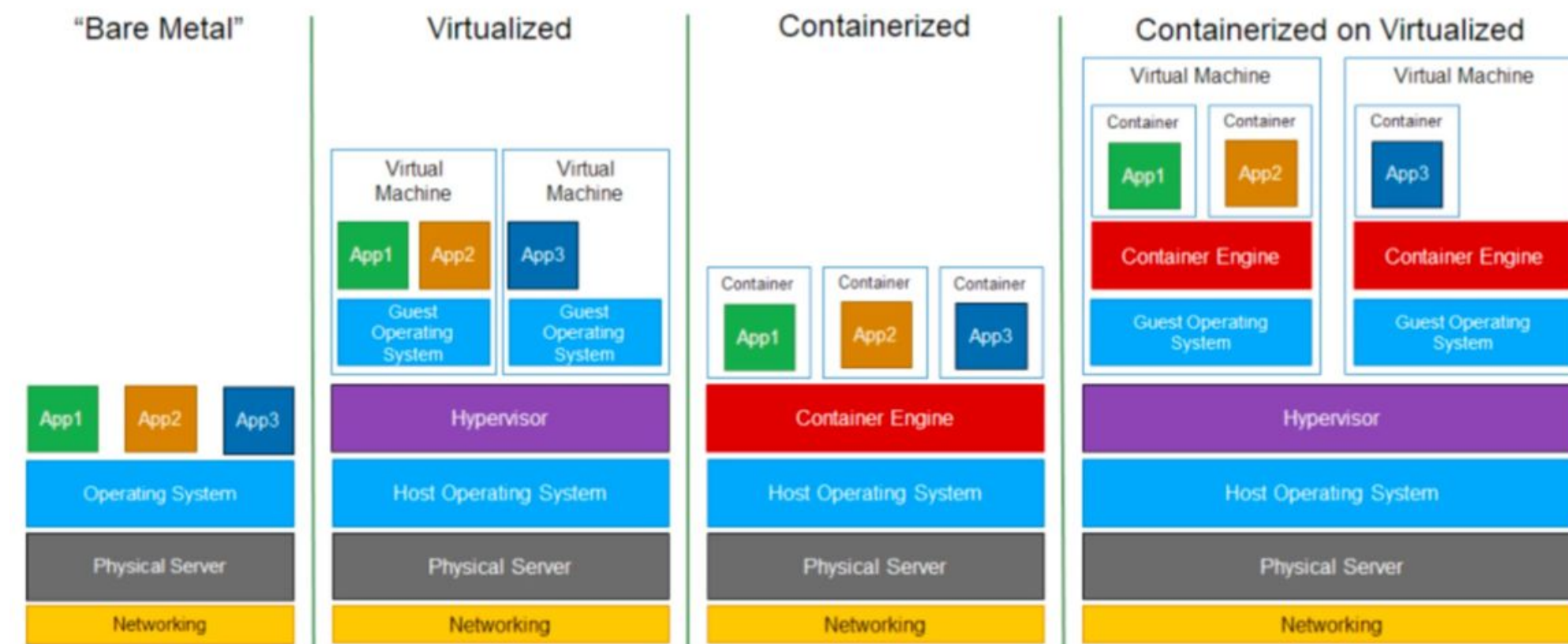
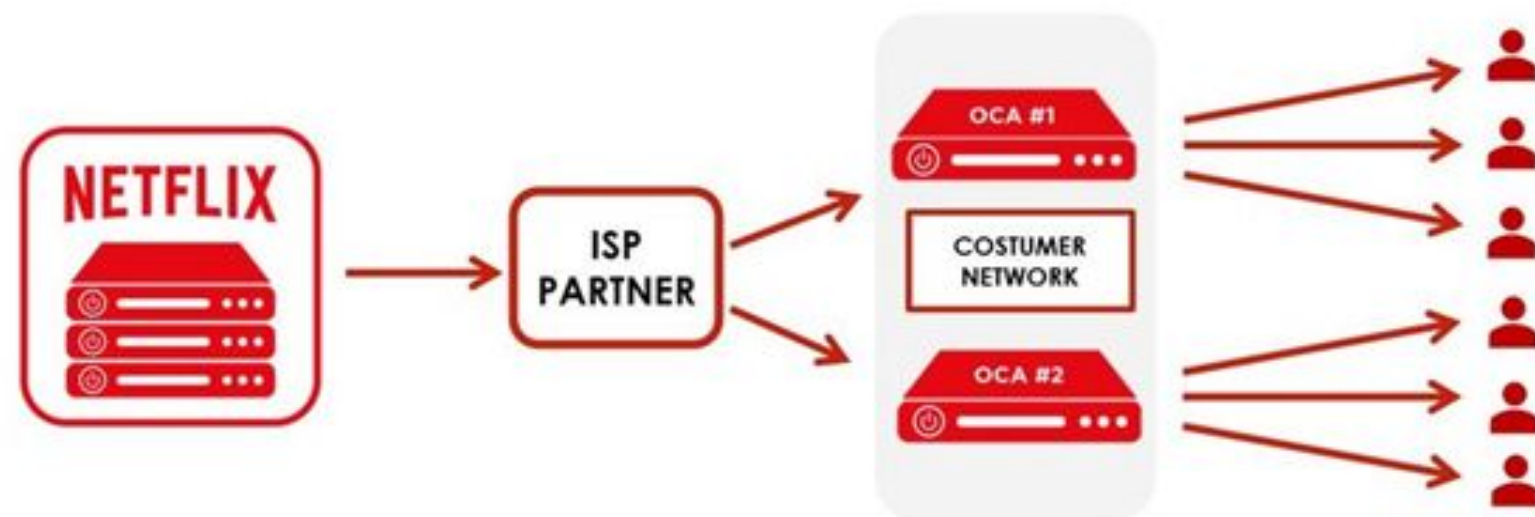
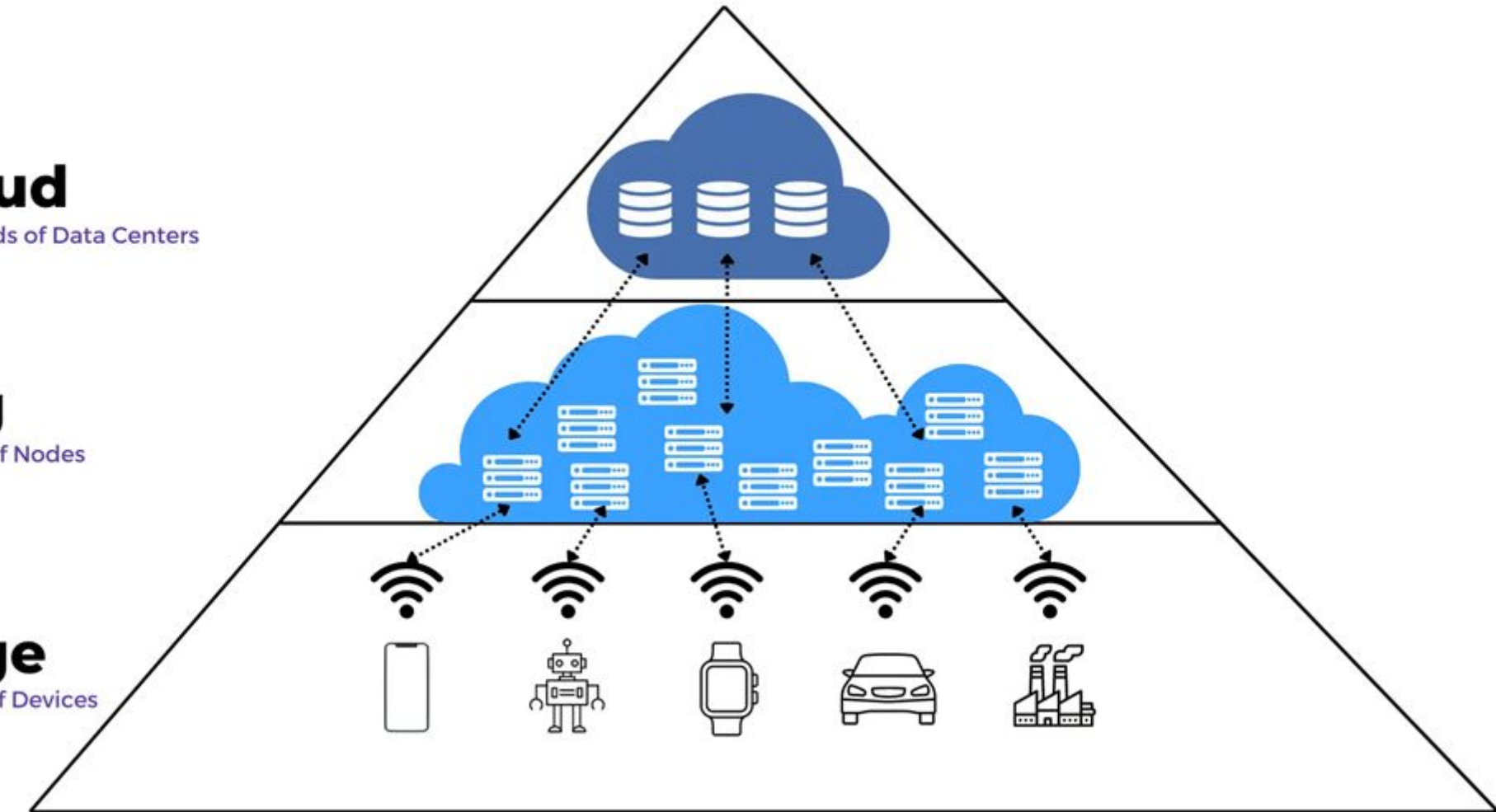

Some time ago...



Nowadays...



New technologies

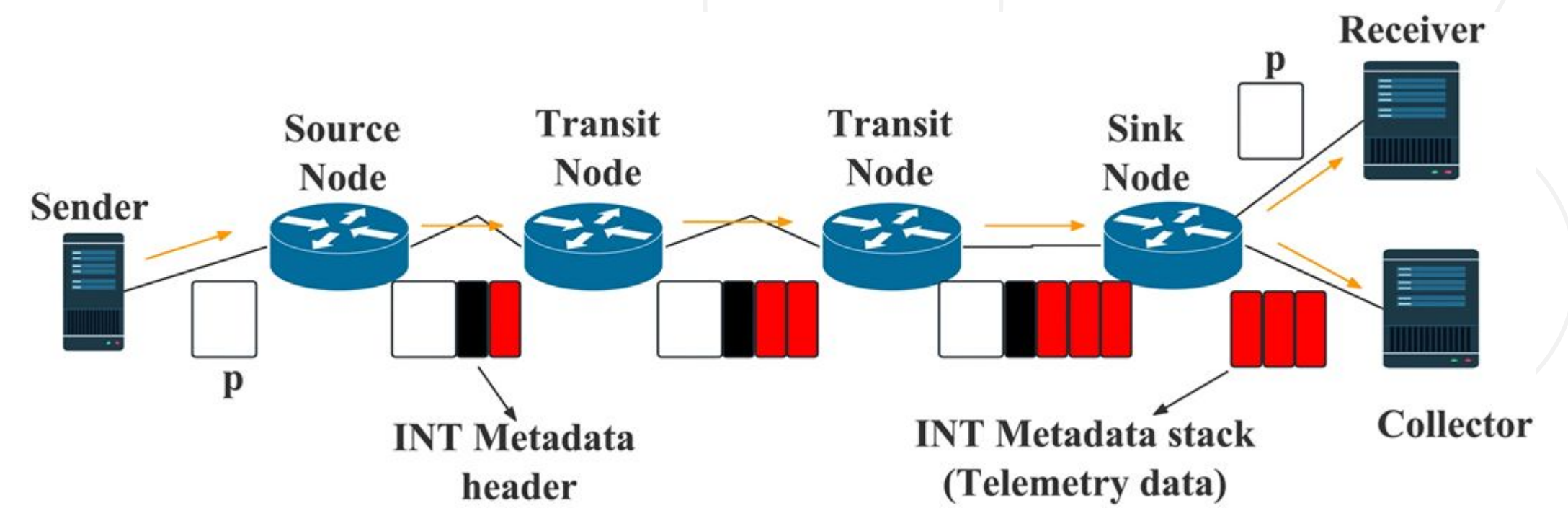
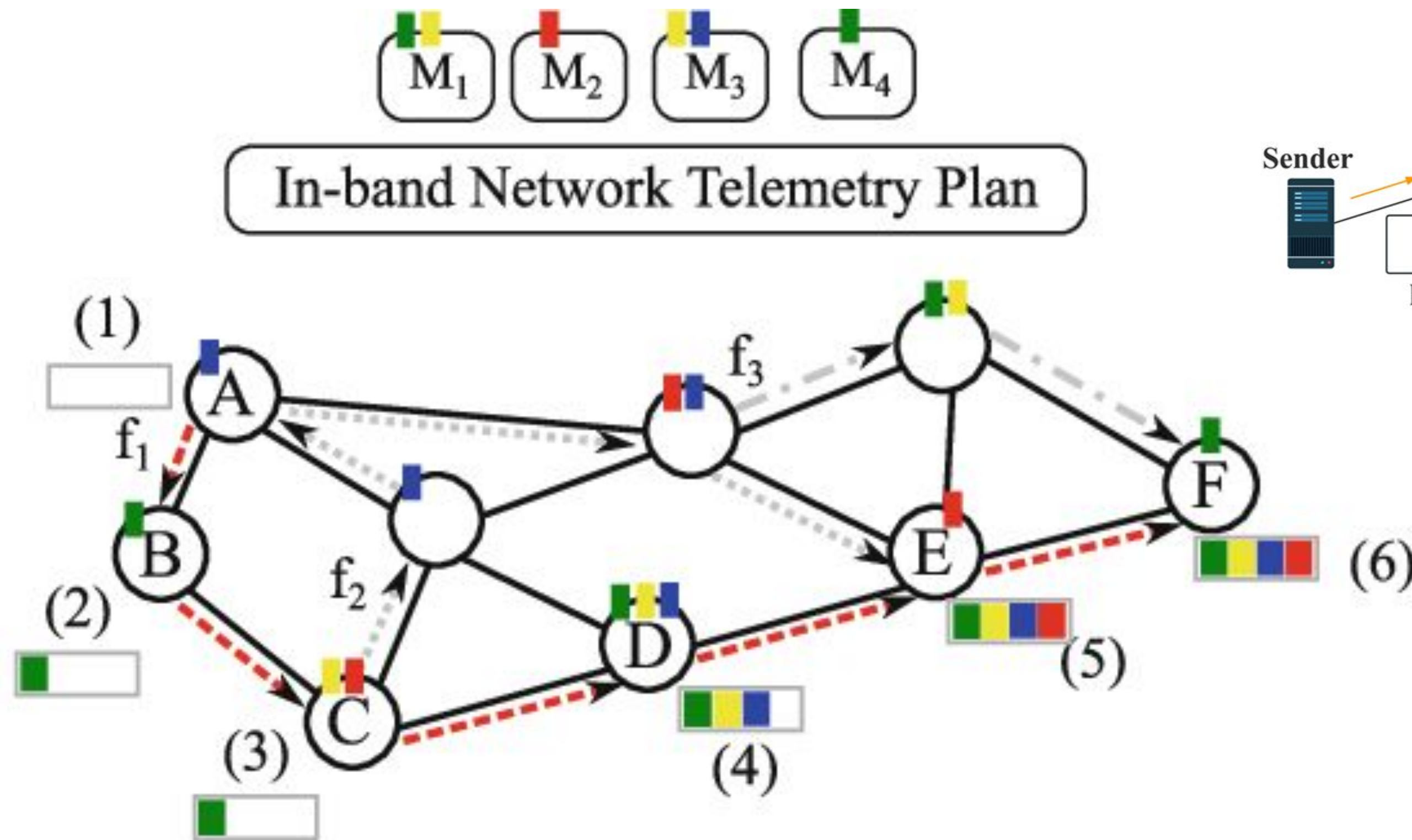

Telemetry data

Monitoring Applications

Service Level Agreements (SLA)



Some Examples of Orchestrators

Expert-based



Some Examples of Orchestrators

Policy-based

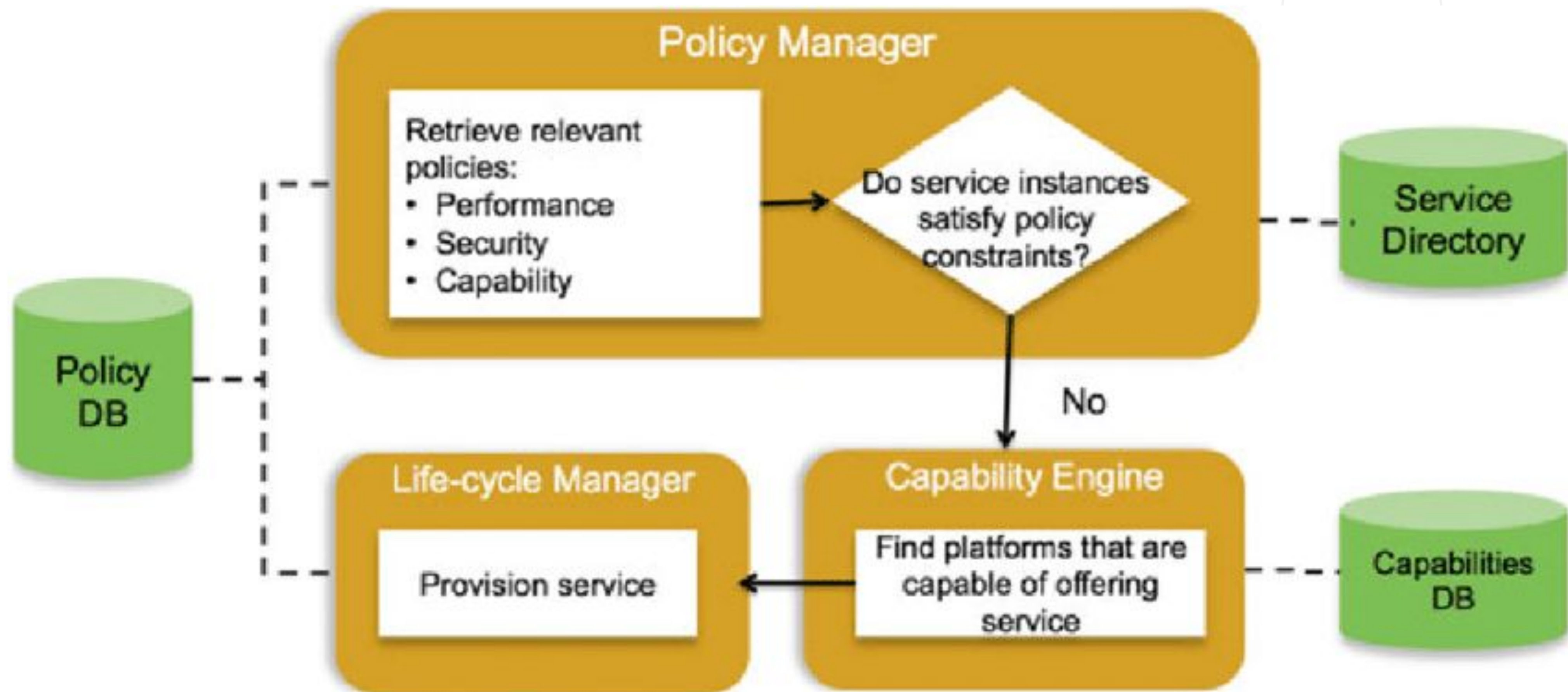

Some Examples of Orchestrators

Threshold



```
link_ut = extract(monitored_data, link_utilization)

if link_ut > sla_threshold
    increase_link_capacity

if link_ut << sla_threshold
    reduce_link_capacity
```

MAPE CYCLE

We are pursuing autonomic control

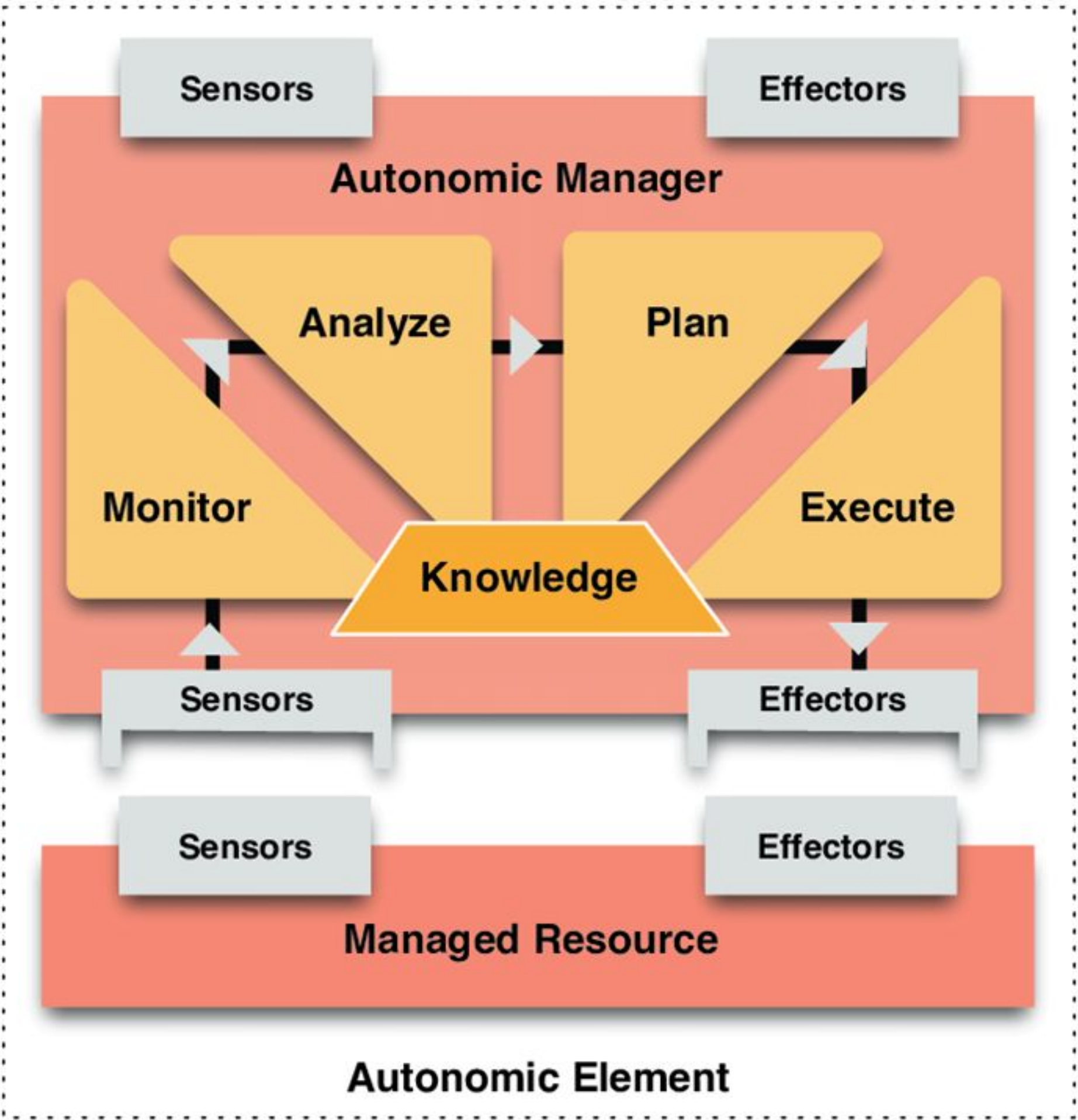

How to use AI for orchestration?

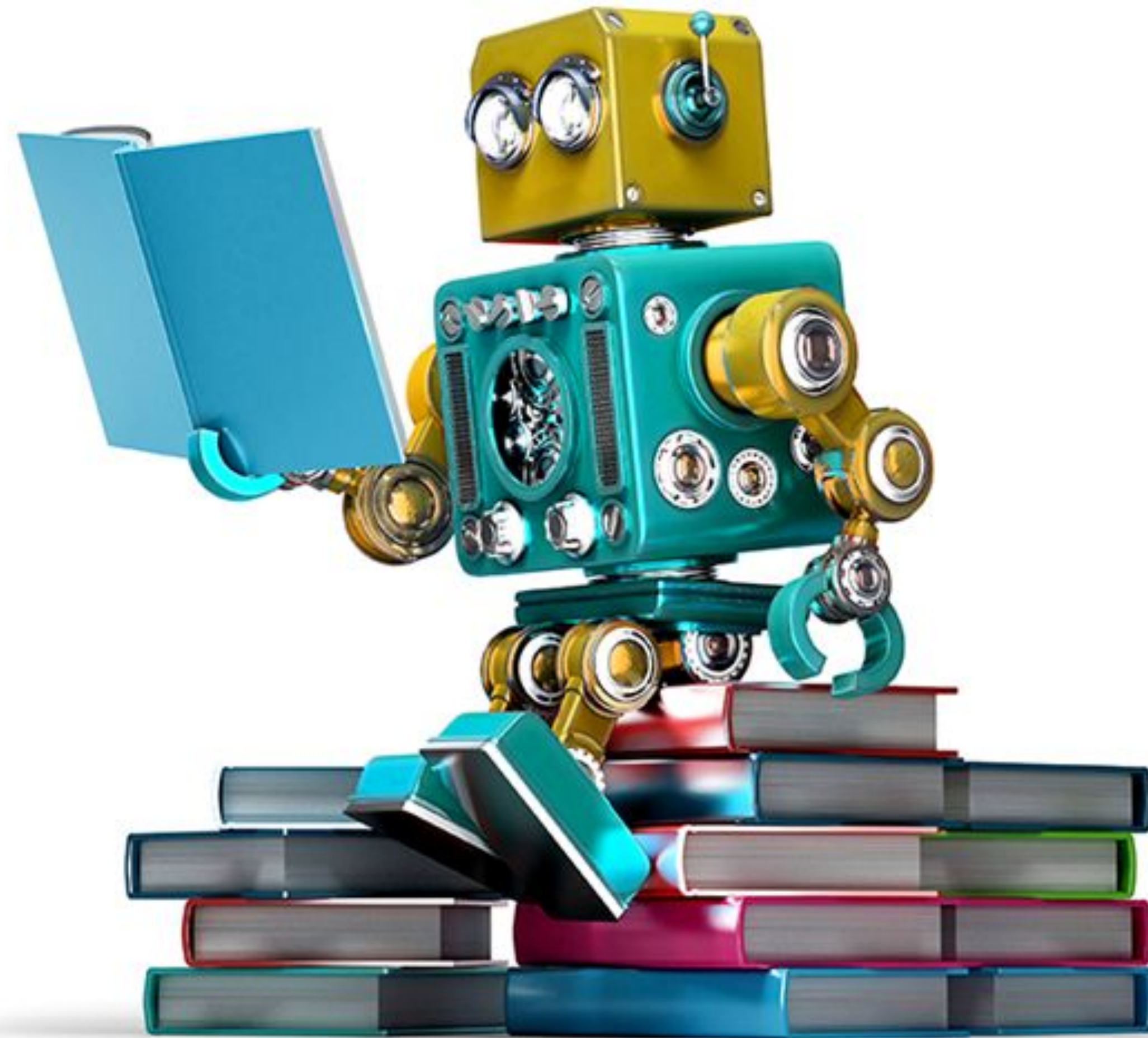

Map infrastructure statistics into service-level metrics

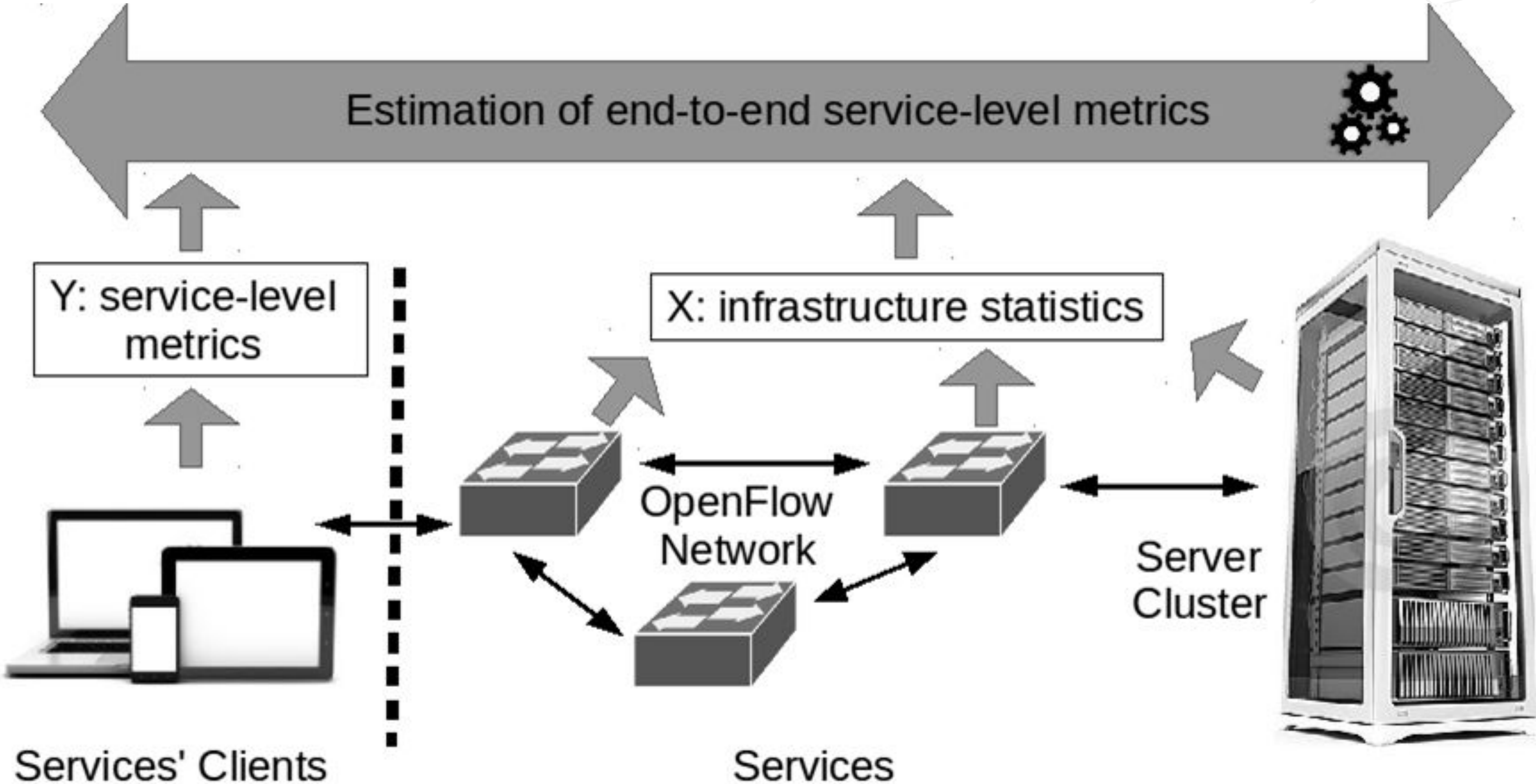

How to collect datasets?

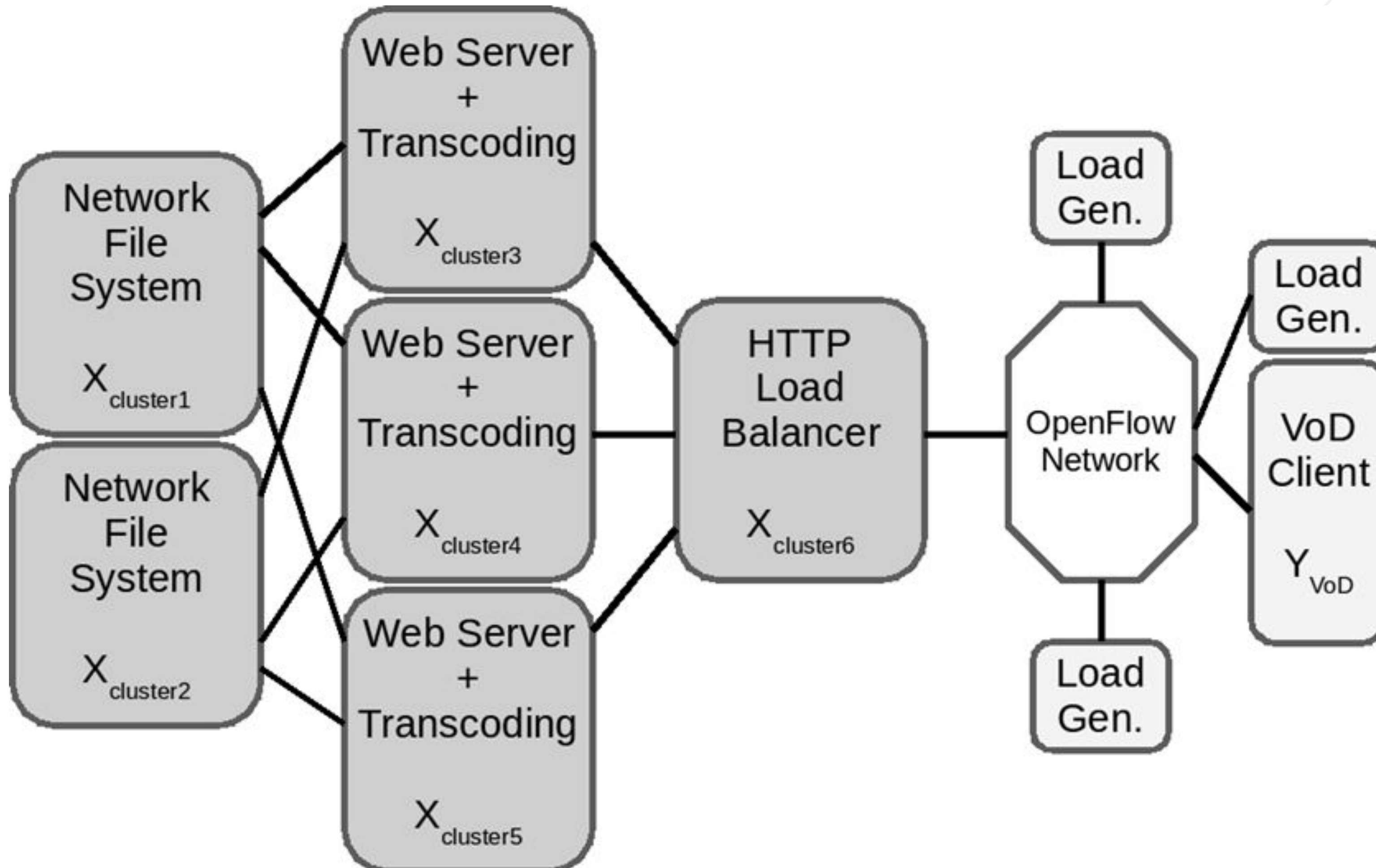

Sensor Node



Load Generator

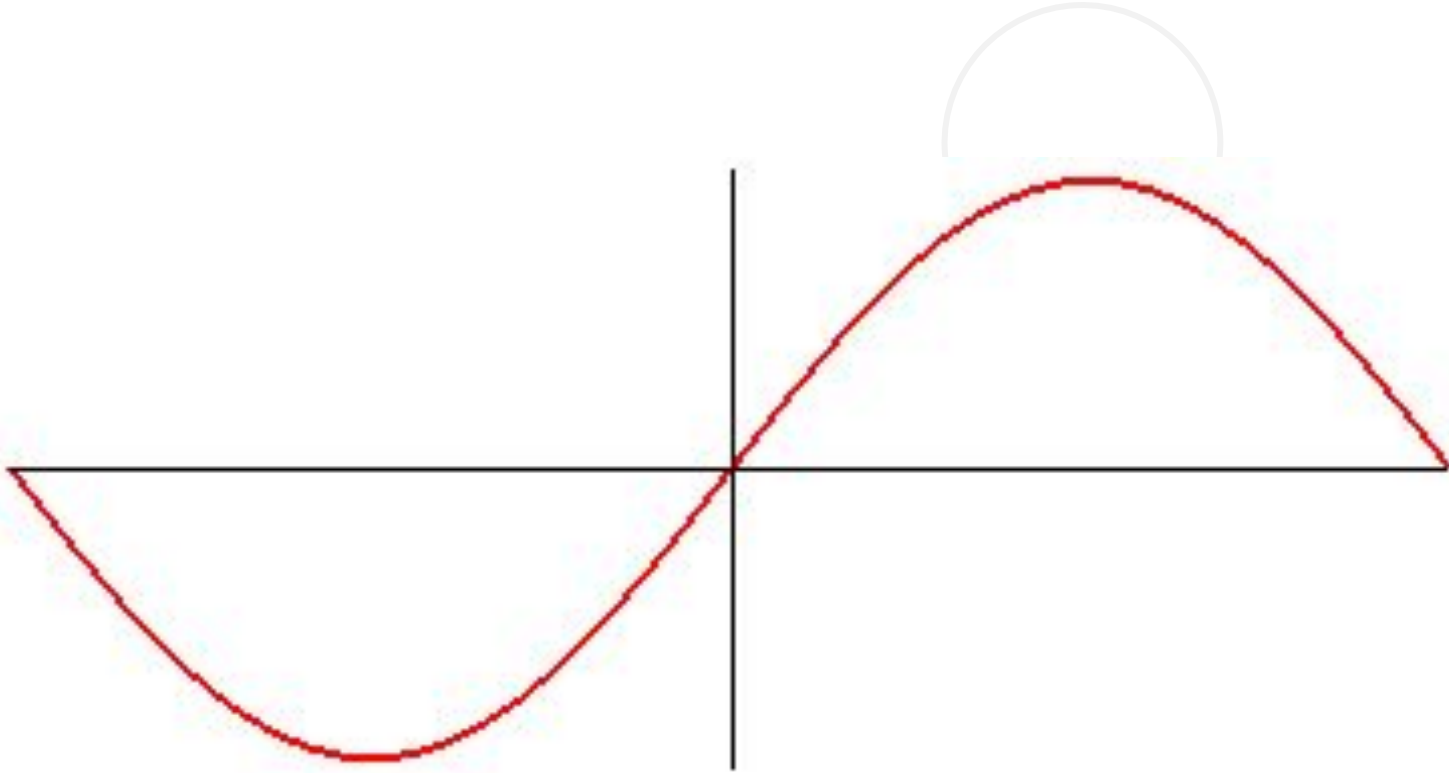
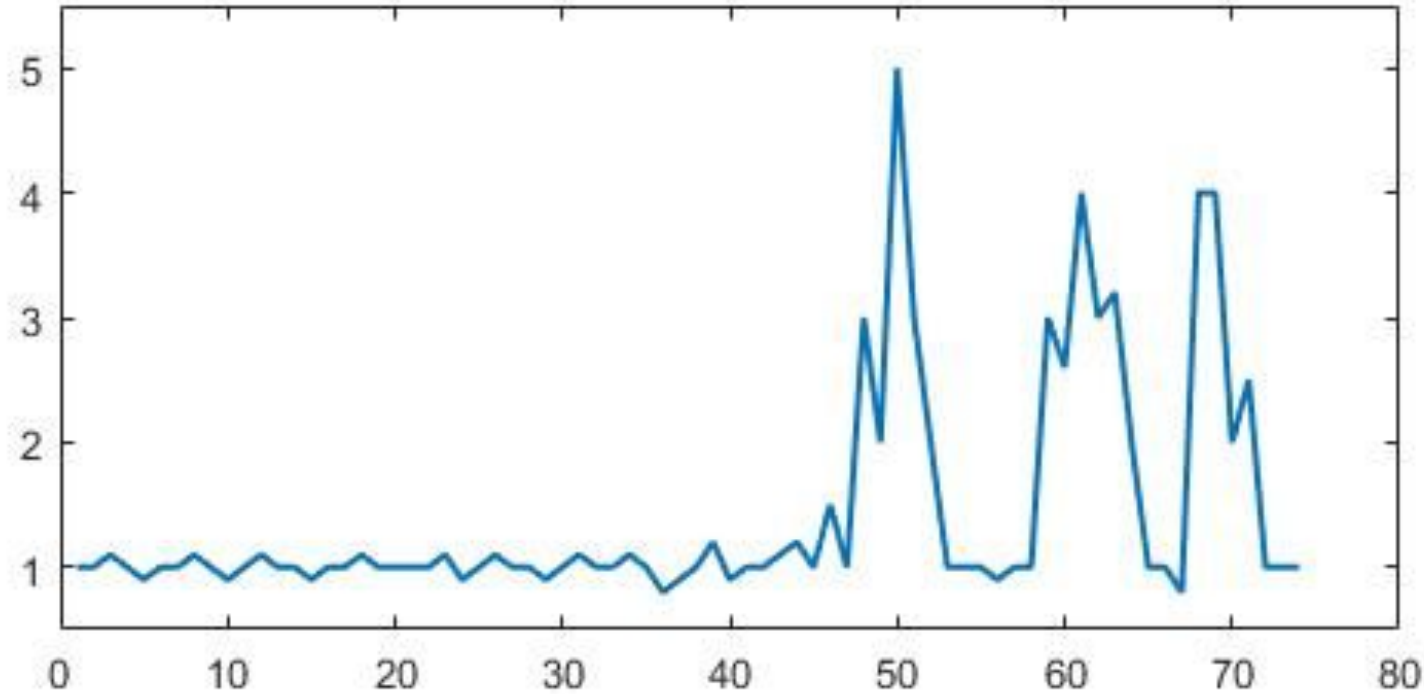
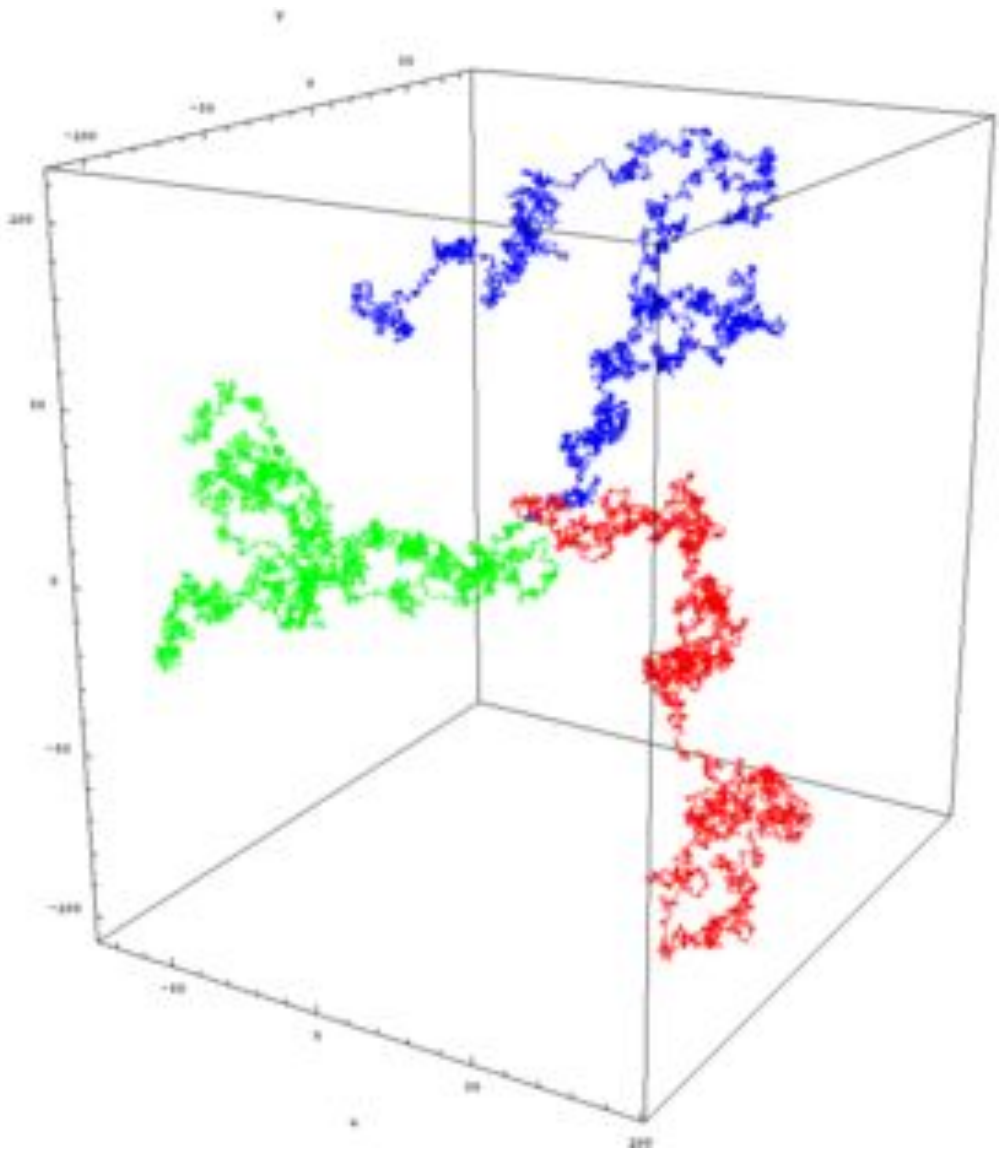

Load Generator

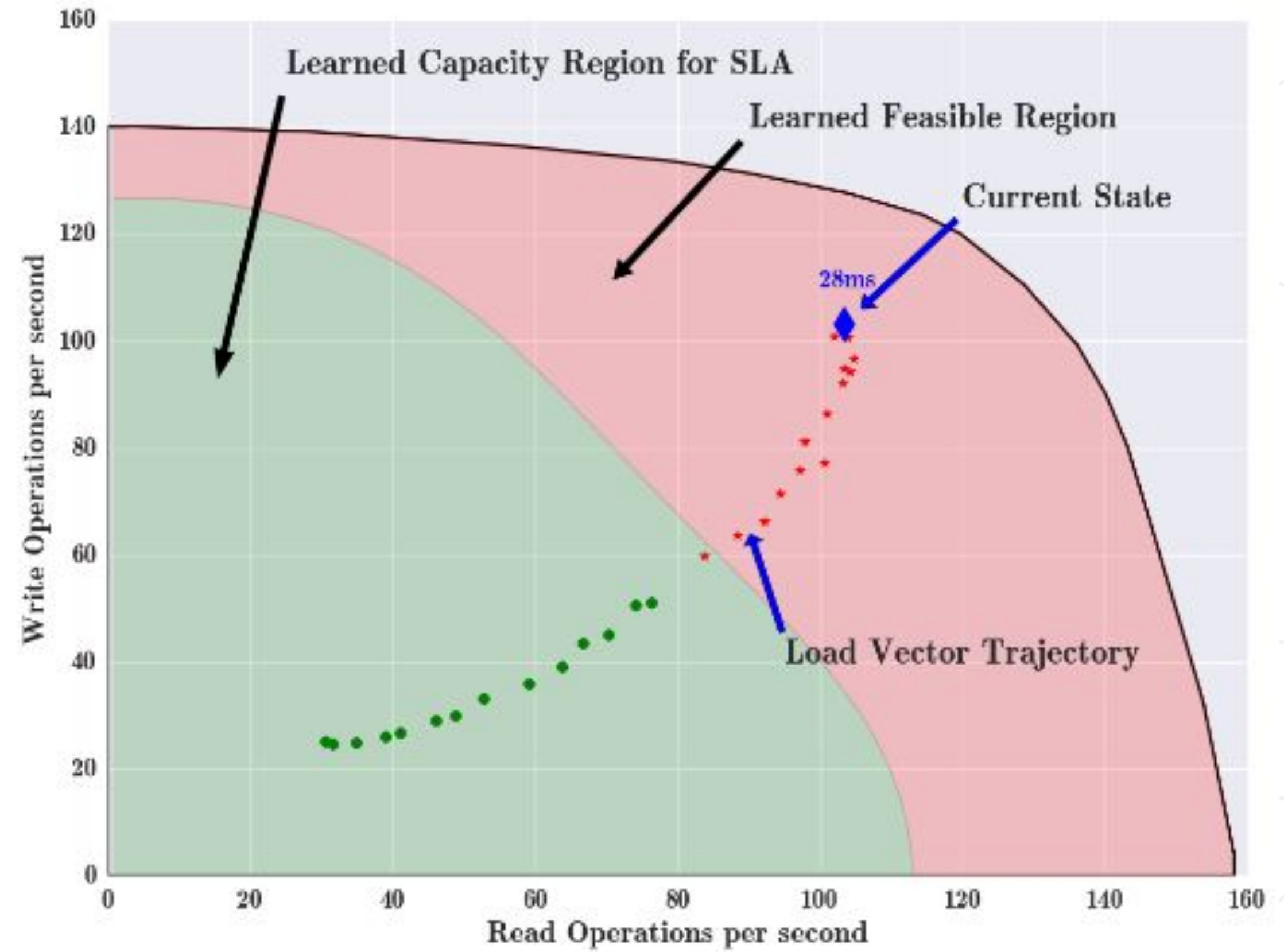
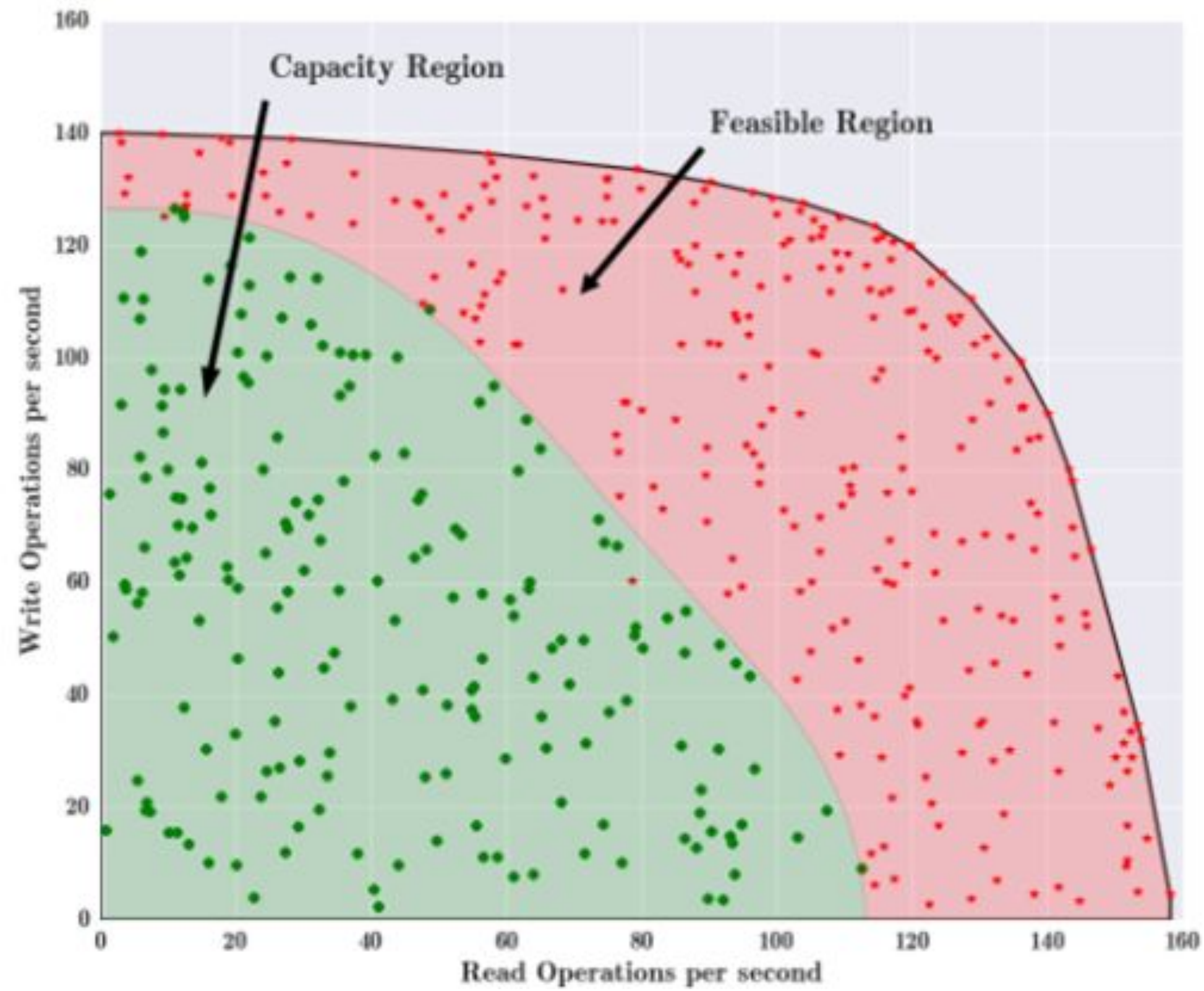

Load Generator

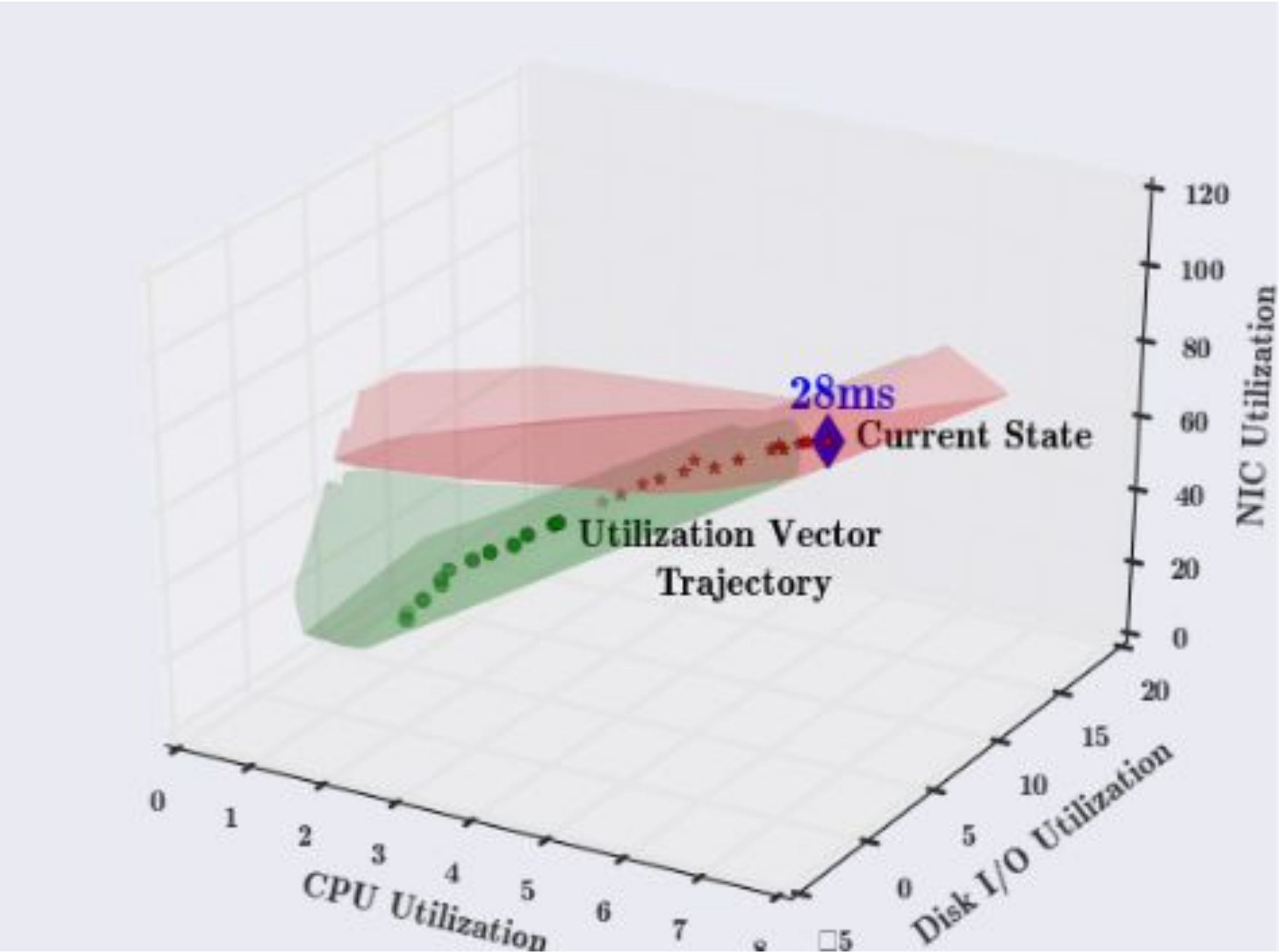

Associate X and Y



```
"TimeStamp", "all_..idle", "X..memused", "proc.s", "cswch.s", "file.nr", "sum_intr.s", "ldavg.1", "tcpsck", "pgfree.s"  
1409264779, 0, 73.03, 47, 62683, 2496, 15802, 64.17, 50, 81151  
1409264780, 0, 73.04, 3, 67595, 2496, 16139, 64.17, 50, 78868  
1409264781, 0, 73.05, 0, 69495, 2496, 15753, 66.15, 49, 79990  
1409264782, 0, 73.06, 0, 67977, 2496, 15849, 66.15, 48, 78462  
1409264783, 0, 73.06, 0, 69409, 2496, 15789, 66.15, 44, 79337  
1409264784, 0, 73.07, 0, 66965, 2496, 15821, 66.15, 43, 71966  
1409264785, 0, 73.08, 9, 65173, 2496, 15998, 66.15, 44, 77254  
1409264786, 0, 73.04, 0, 64548, 2496, 15884, 67.42, 43, 76346  
1409264787, 0, 73.06, 0, 65286, 2496, 17025, 67.42, 42, 72975
```

```
"TimeStamp", "DispFrames"  
1409264779, 17.2699992657  
1409264780, 22.4399995804  
1409264781, 24  
1409264782, 20.9500005245  
1409264783, 15.3400006294  
1409264784, 17.8799991608  
1409264785, 22.8299996853  
1409264786, 24  
1409264787, 20.3400006294
```



"You're telling me it will take 13 years to install my education! What kind of outdated software is this school using?"



SMARTNESS

