

Taller de Técnicas de Medición en Hidrología e Hidráulica

Módulo: Hidráulica de ambientes costeros

Clase 4: Repaso sobre hidrodinámica de la zona de rompiente
y presentación del sistema de monitoreo de playas en base
a imágenes.



UNIVERSIDAD
DE LA REPÚBLICA
URUGUAY



Flujo de momentum integrado en la vertical y
promediado en la ola

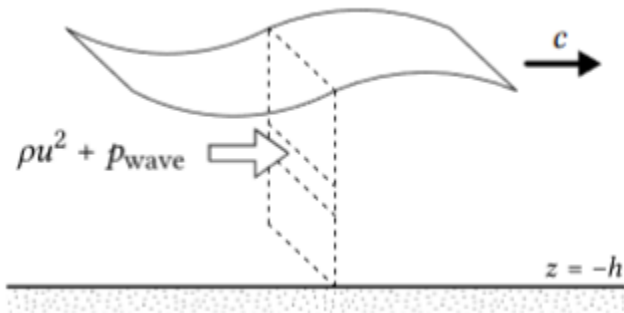

$$S_{xx} = \underbrace{\int_{-h_0}^{\eta} (\rho u_x) u_x dz}_{\text{part due to advection by horizontal particle velocity}} + \underbrace{\int_{-h_0}^{\eta} p_{\text{wave}} dz}_{\text{pressure part}}$$

$$S_{yy} = \underbrace{\int_{-h_0}^{\eta} (\rho u_y) u_y dz}_{\text{part due to advection by horizontal particle velocity}} + \underbrace{\int_{-h_0}^{\eta} p_{\text{wave}} dz}_{\text{pressure part}}$$

$$S_{xy} = \int_{-h_0}^{\eta} (\rho u_x) u_y dz$$

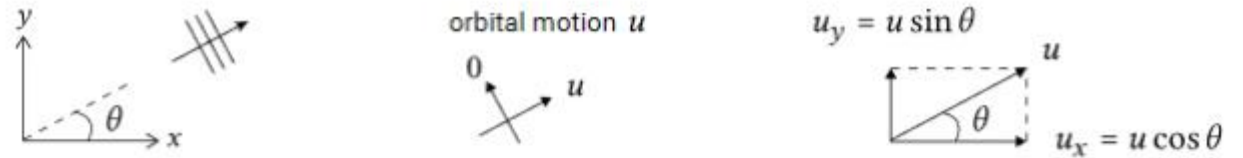

Figure 5.28: Coordinate system and velocity vector.

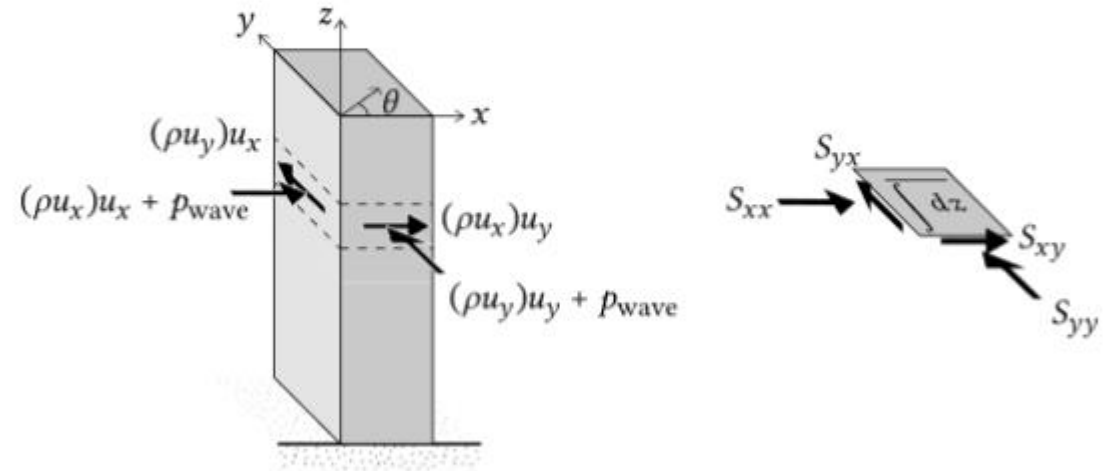

Figure 5.29: Schematic of the momentum transport and radiation stress components at a certain point in x, y -space for obliquely incident waves. The radiation stresses are obtained by integration of the momentum transport over the water column and averaging in time.

Cálculo a partir de teoría lineal

$$\begin{aligned}
 \longrightarrow & S_{xx} = \underbrace{\left(n - \frac{1}{2}\right) E}_A + \underbrace{n \cos^2 \theta E}_B \\
 \dashrightarrow & S_{xy} = \underbrace{n \sin \theta \cos \theta E}_B \\
 \uparrow & S_{yy} = \underbrace{\left(n - \frac{1}{2}\right) E}_A + \underbrace{n \sin^2 \theta E}_B \\
 \uparrow \text{ (dashed)} & S_{yx} = \underbrace{n \cos \theta \sin \theta E}_B
 \end{aligned}$$

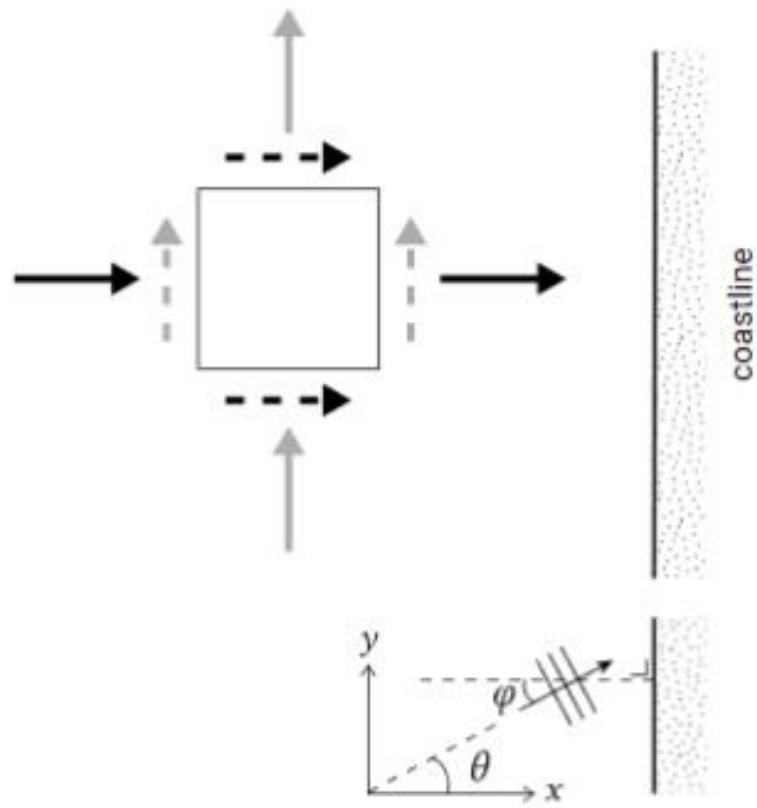
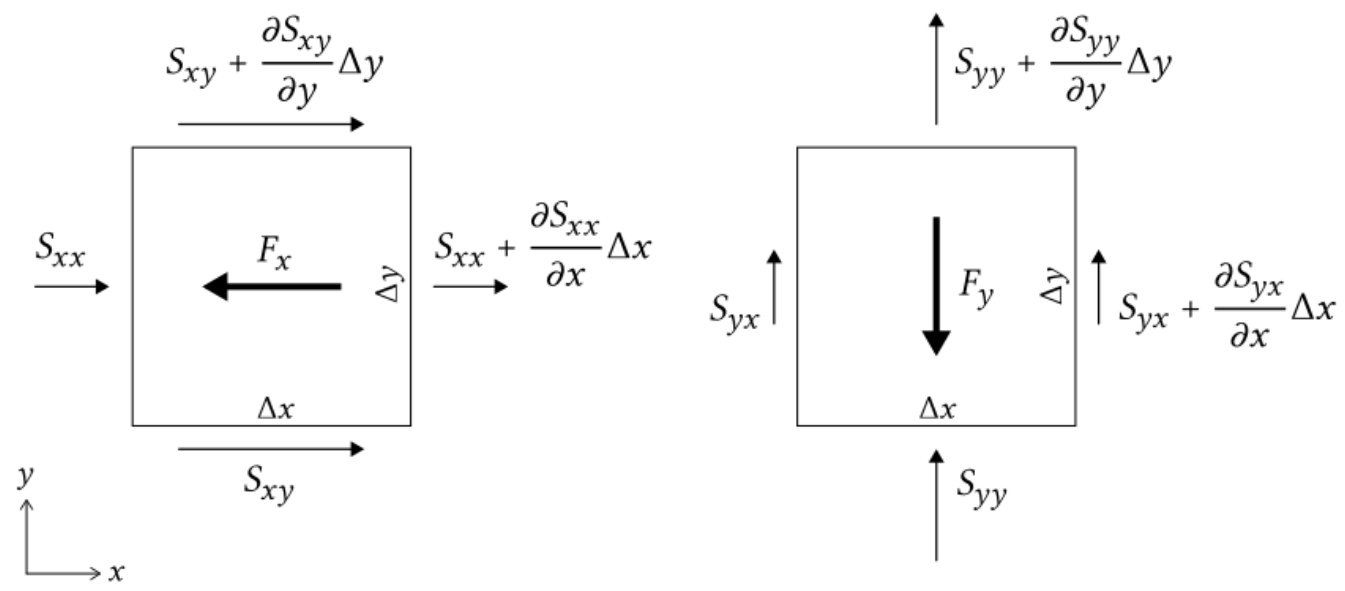

Figure 5.30: Radiation stress components according to linear wave theory. Situation sketch for alongshore uniform coast with depth contours parallel to y -axis. 'A' indicates the pressure part, 'B' indicates the part due to advection by the horizontal particle velocity.



Forzamiento inducido por el oleaje



$\frac{\partial S_{xx}}{\partial x} \longrightarrow$ *Set up y Set down*

$\frac{\partial S_{xy}}{\partial x} \longrightarrow$ *Corriente litoral*

Balance mecánico *cross-shore*

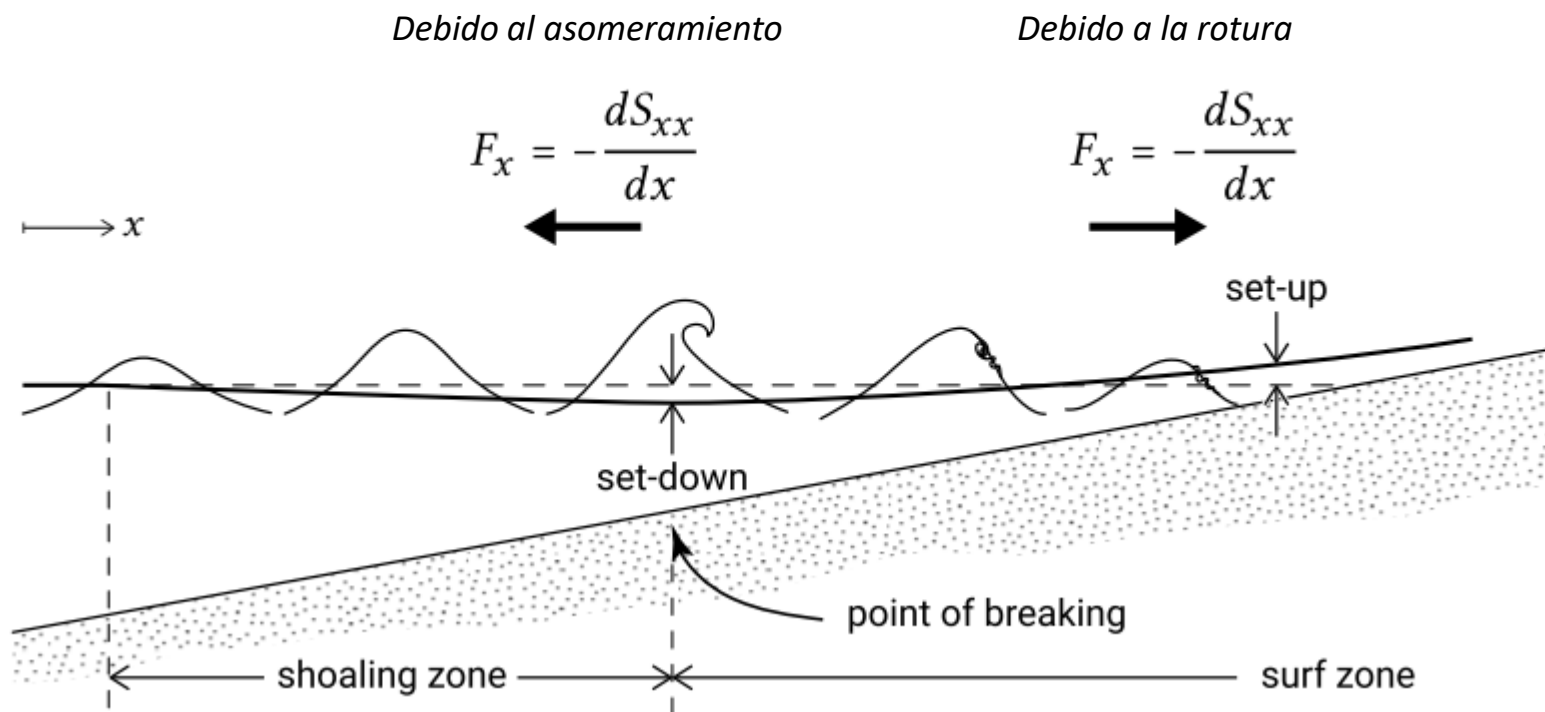

Balance mecánico *cross-shore*

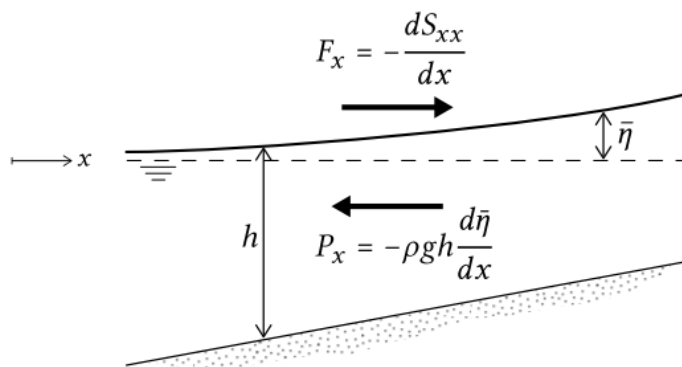

$$-\frac{dS_{xx}}{dx} = \rho g h \frac{d\bar{\eta}}{dx} = \rho g (h_0 + \bar{\eta}) \frac{d\bar{\eta}}{dx}$$

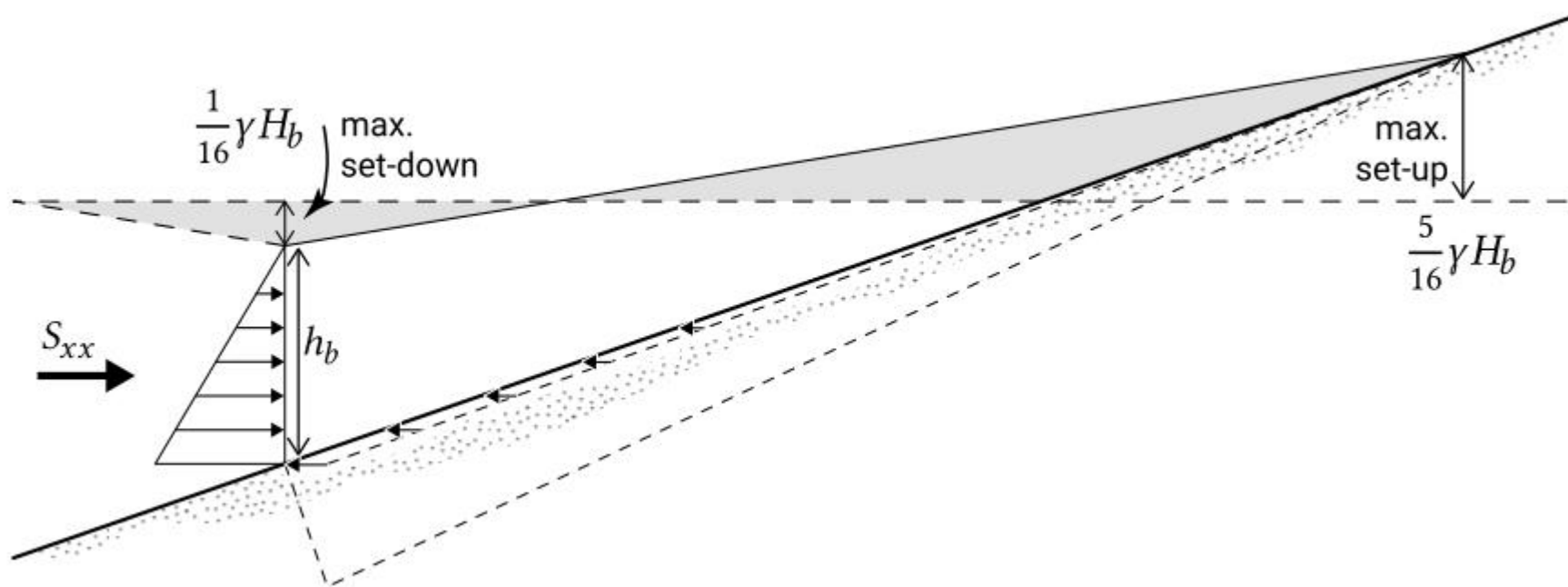

Balance mecánico *along-shore*

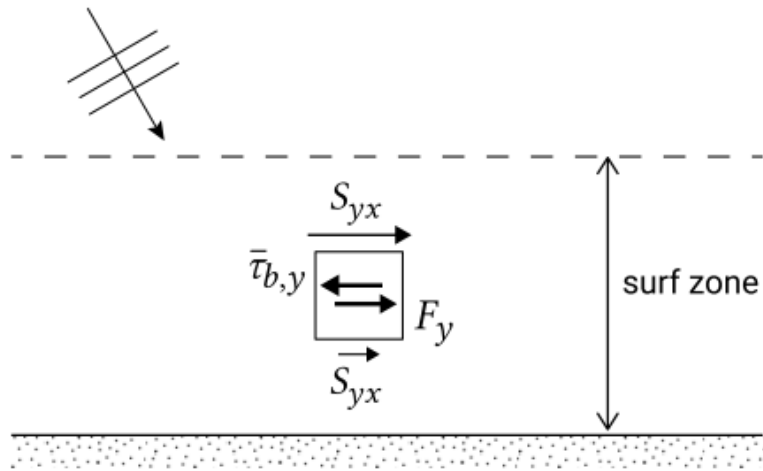

$$F_y = -\frac{dS_{yx}}{dx} = \bar{\tau}_{b,y}$$

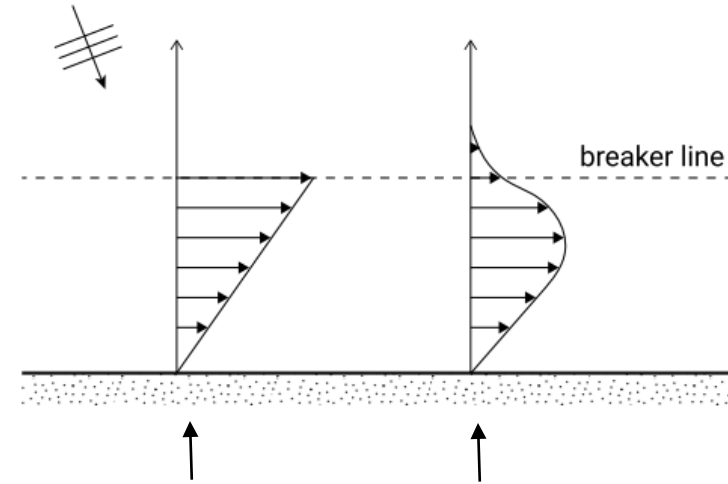

Resultado modelo analítico

Influencia de vórtices horizontales

Patrones inducidos por zona de sombra detrás de estructuras

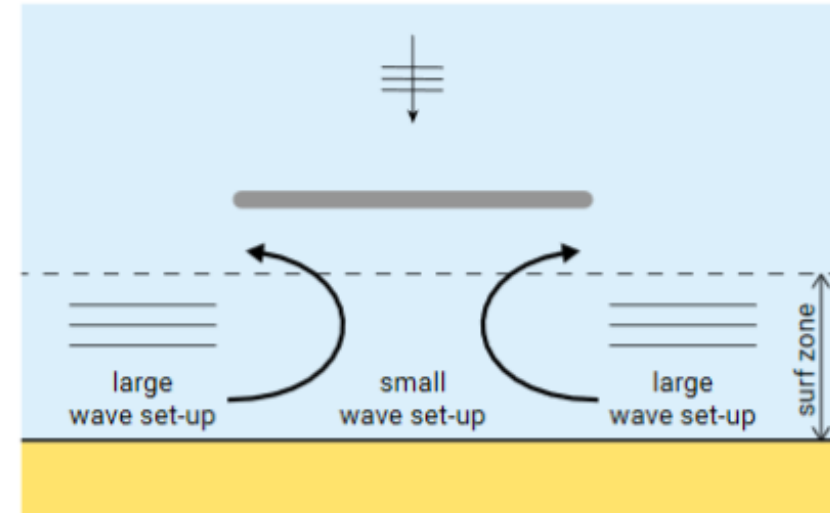
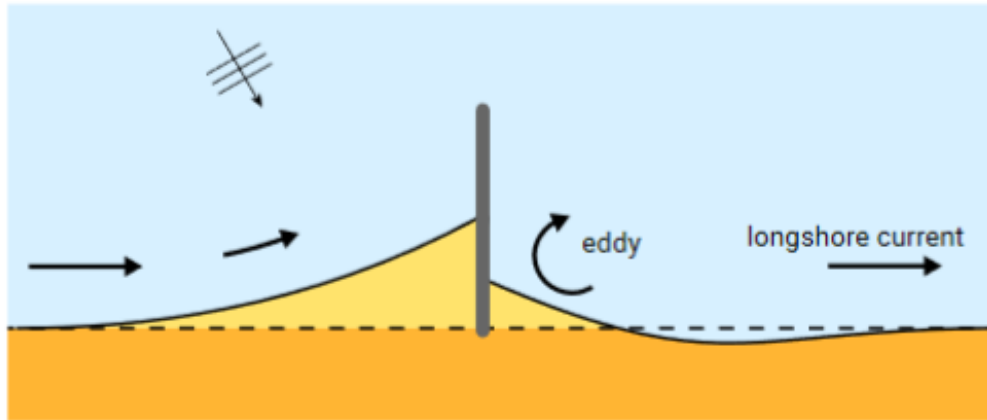

Corrientes de retorno

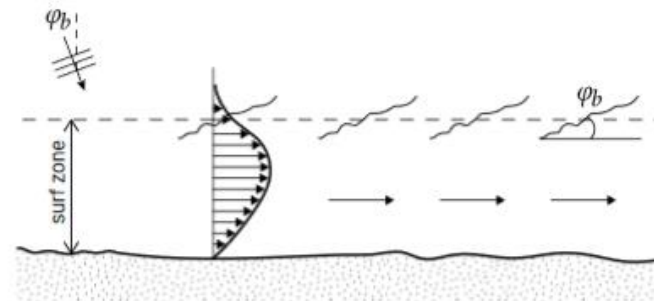

(a) typical longshore current distribution in the case of obliquely incident waves

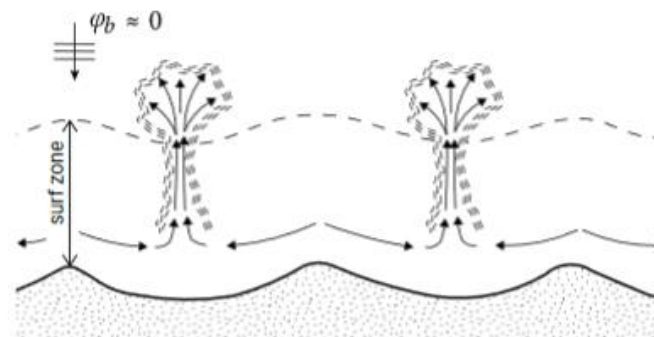

(b) rip current pattern for undulating coastline in the case of approximately normal incidence

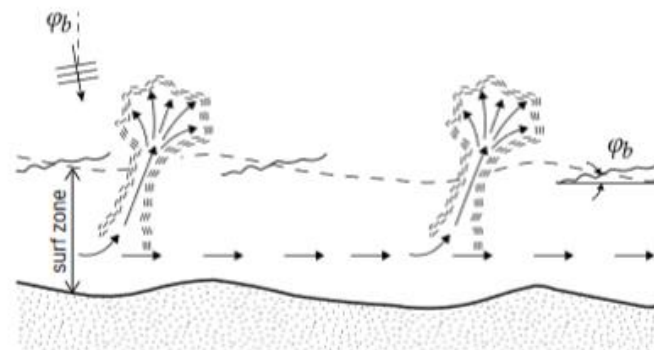

(c) combination of previous two cases for slightly oblique waves

Circulación entorno a bajos

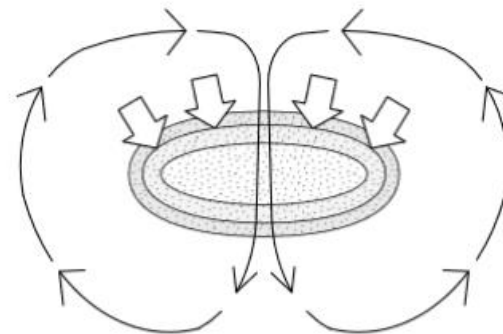

Figure 5.48: Wave-induced forces (white wider arrows) and currents (dark thinner arrows) around a shoal.

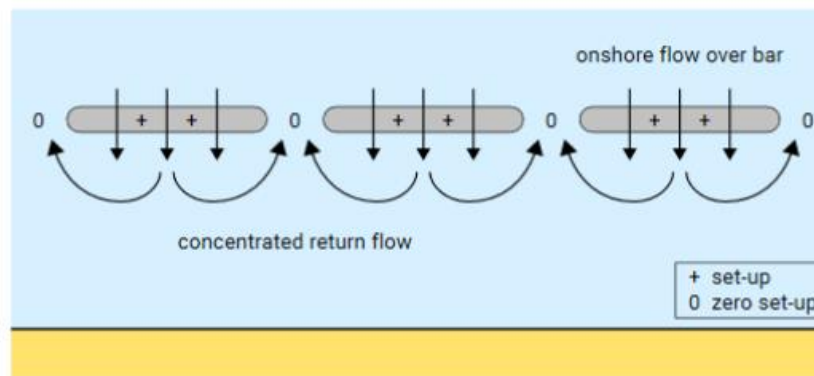
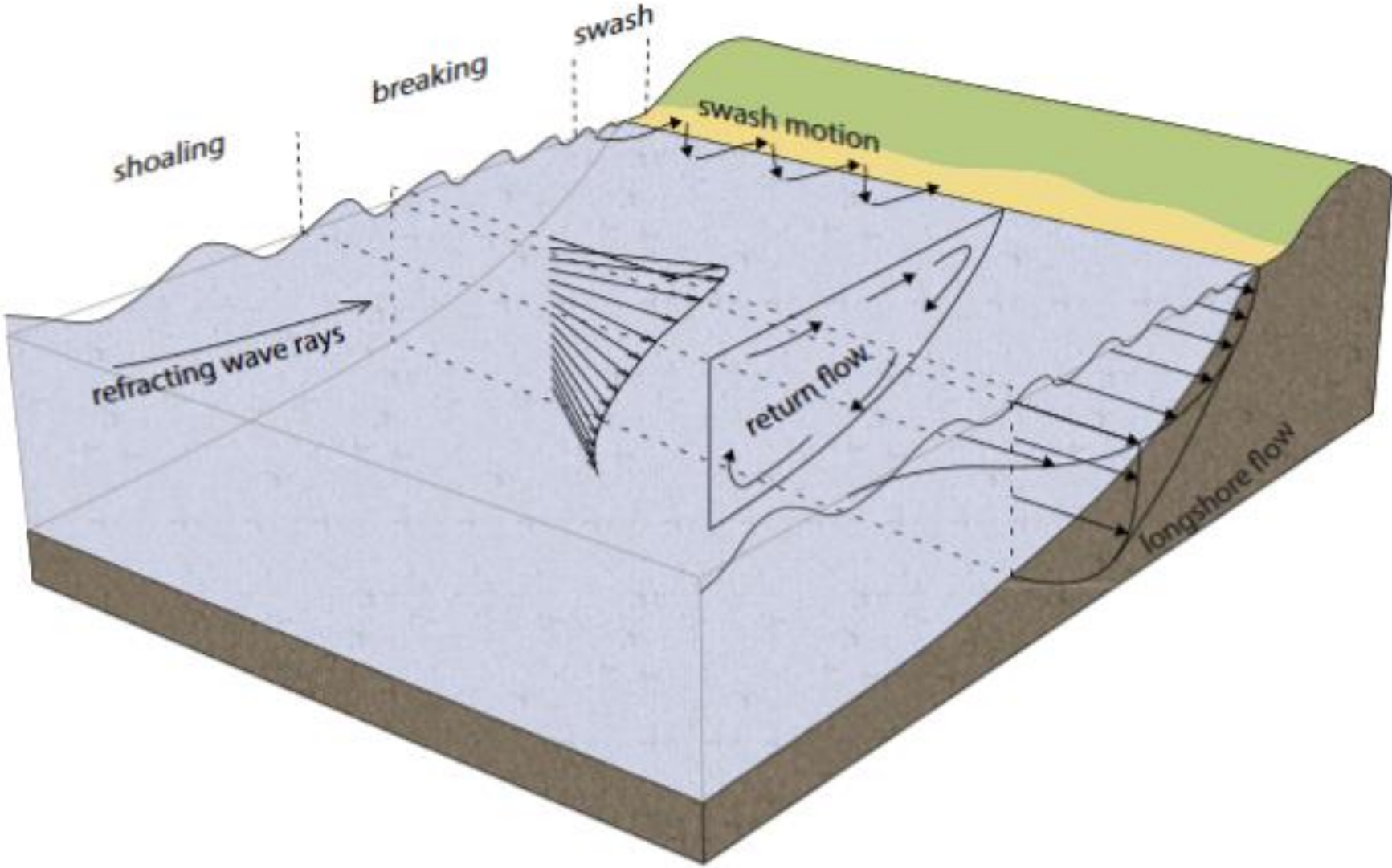
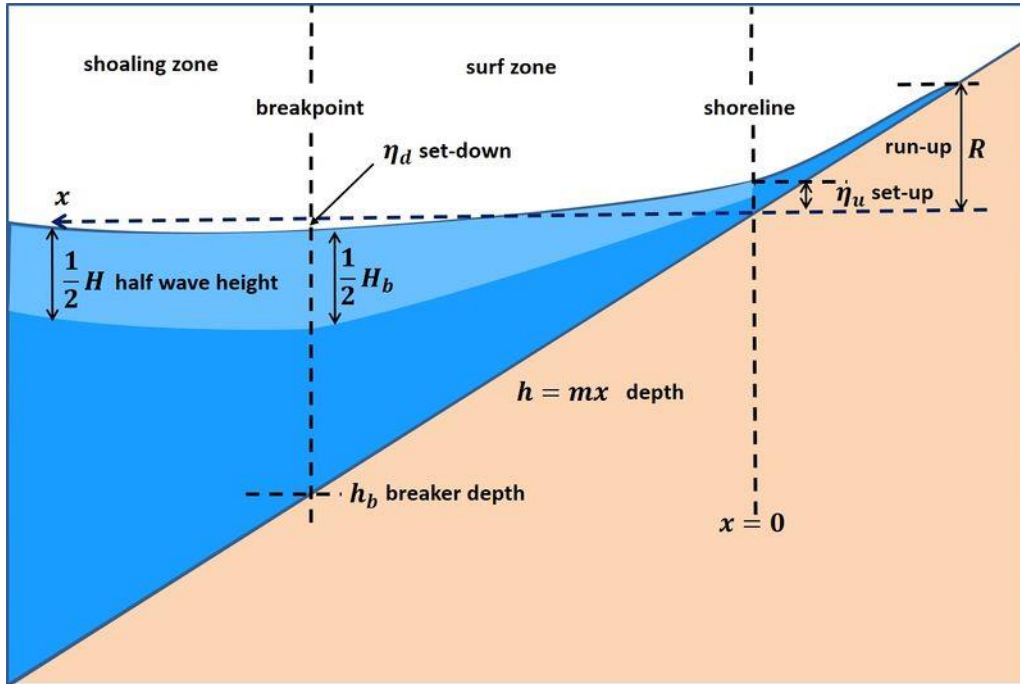

Figure 5.49: Rip currents in the case of submerged breakwaters (or an interrupted bar system).





Tomado de Coastalwiki

Siendo:

$$\xi = \frac{\beta}{(H/L_0)^{1/2}} \cdot (\text{Iribarren})$$

R_2 es el run-up excedido el 2% del tiempo (Oleaje irregular)

$$H_0 = H_{s,0}$$

β es la pendiente del frente de playa

Stockdon et al. (2006):

Formulación empírica para estimar Run-up en playas naturales

$$\xi_0 < 0.3 \quad R_2 = 0.043(H_0 L_0)^{1/2}.$$

$$0.3 \leq \xi_0 \leq 1.25 \quad R_2 = 1.1 \left(0.35 \beta_f (H_0 L_0)^{1/2} + \frac{[H_0 L_0 (0.563 \beta_f^2 + 0.004)]^{1/2}}{2} \right)$$

$$(\xi_0 > 1.25) \quad R_2 = 0.73 \beta_f (H_0 L_0)^{1/2}.$$