



LoRaWAN

Germán Capdehourat

Tecnologías para la Internet de las Cosas (TloT)
2024





LoRaWAN

Application

LoRaWAN[®] Standard

LoRa[®]



Arquitectura de LoRaWAN

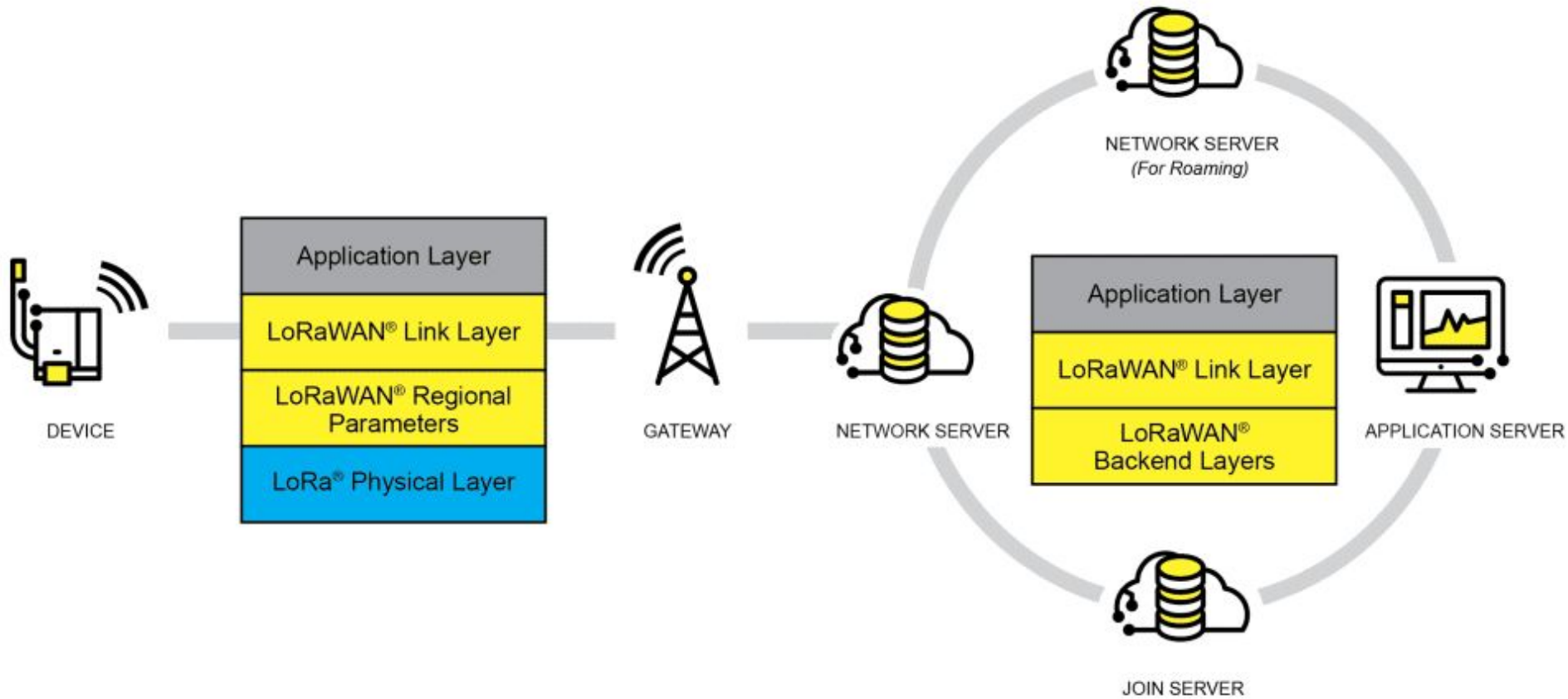



Agenda



- Arquitectura y capas de la red LoRaWAN.
- Nodos, gateways y network server.
- Bandas de frecuencia y canales.
- Capa física (RF) y acceso al medio.
- Estructura de las tramas.
- Configuración de los nodos: aprovisionamiento vía ABP y OTAA.
- Seguridad, ADR y geolocalización.
- Configuración de gateway y servidor de red.
- Ejemplo de diseño de red LoRaWAN.





Arquitectura de la red

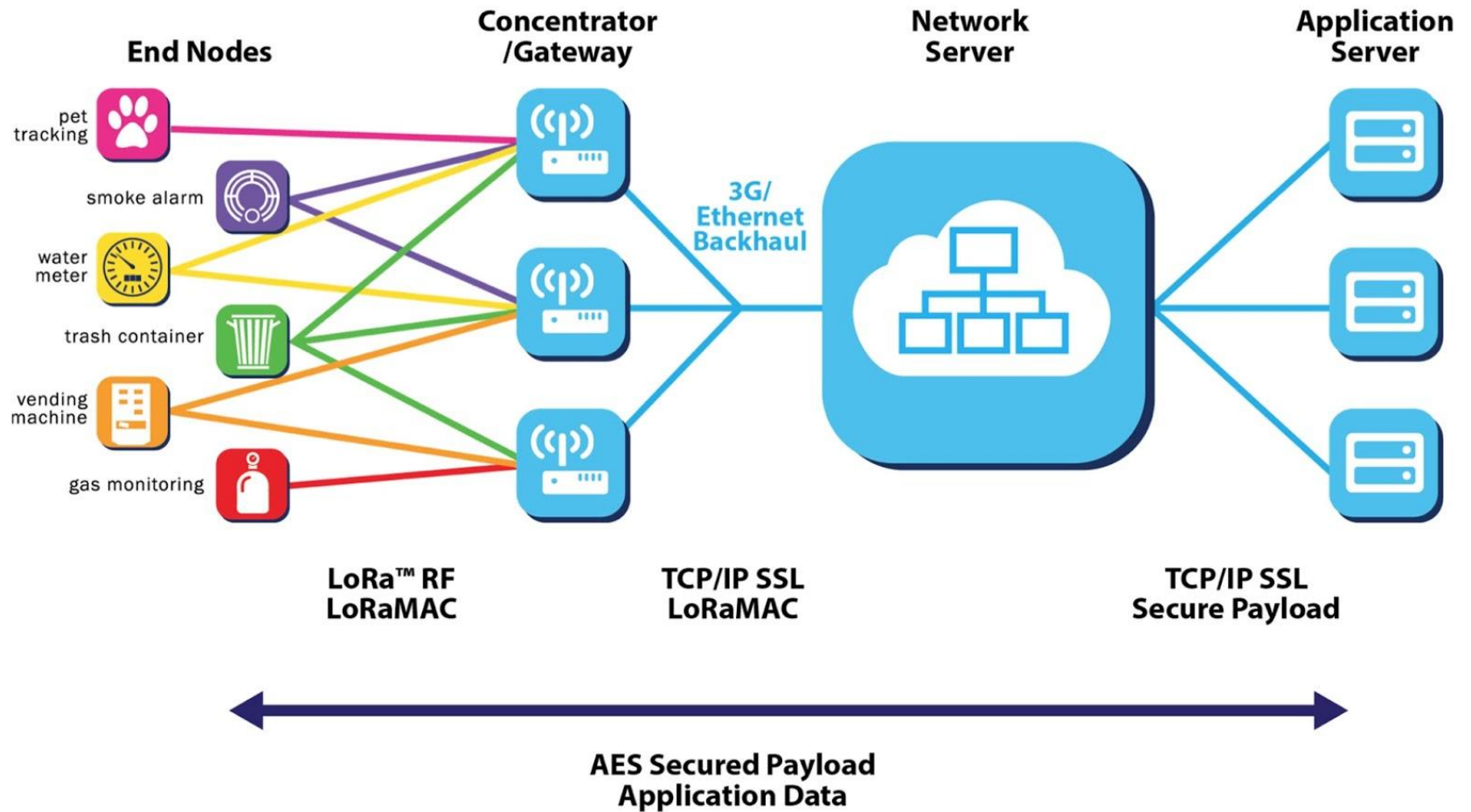



Arquitectura de la red



LoRaWAN End-to-End Architecture

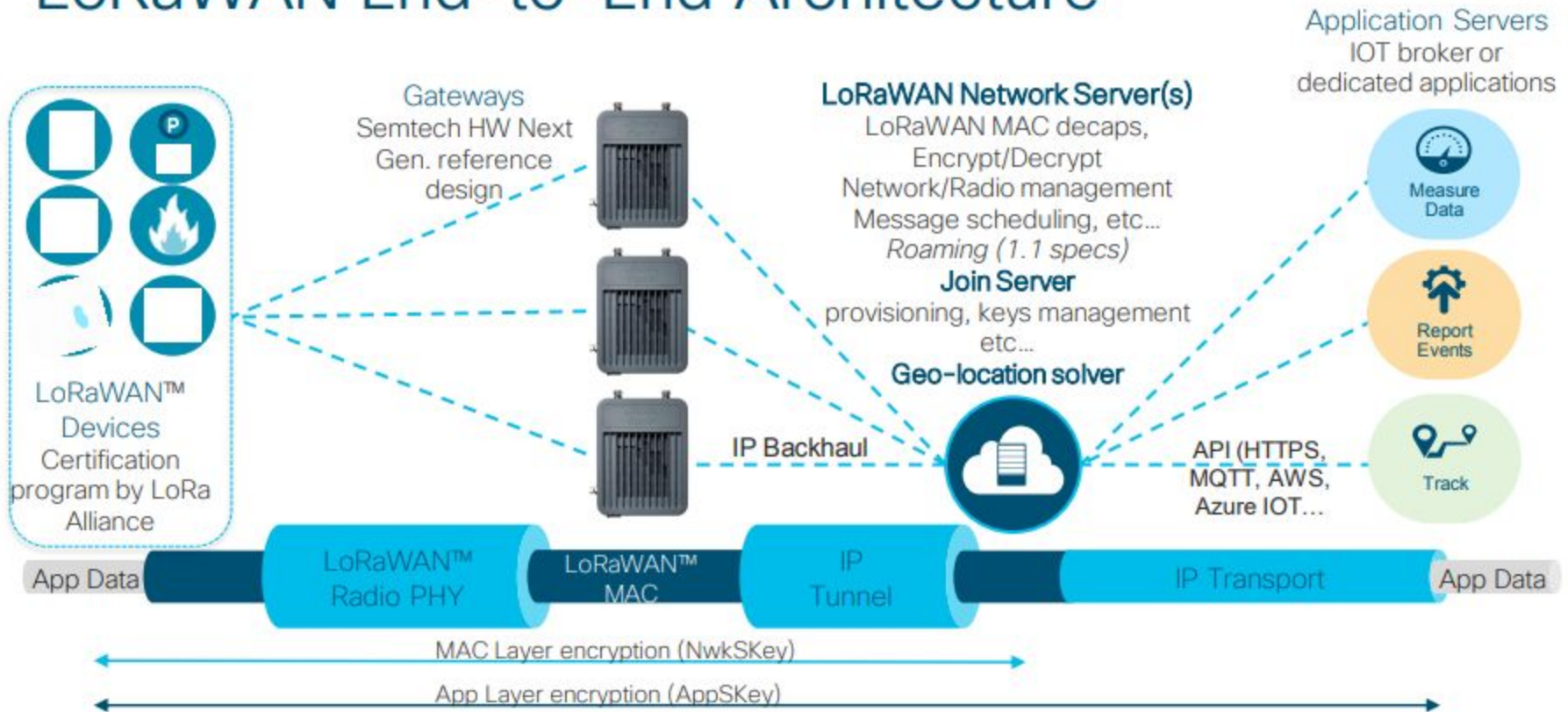



Arquitectura de la red

Modulation	LoRa RF (Spread Spectrum)
Range	~ 15 Km
Throughput	~ 50 Kbps

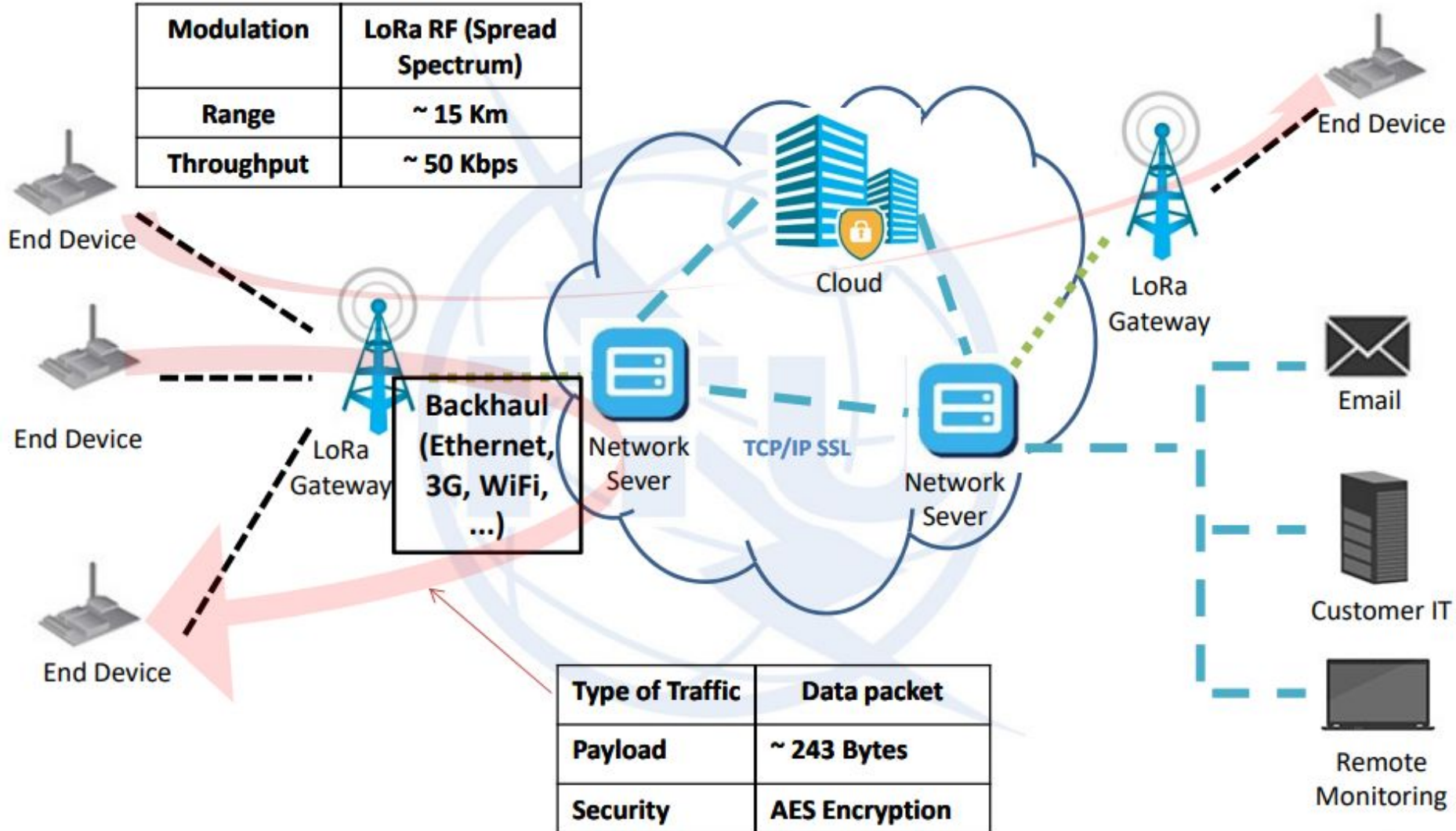

Type of Traffic	Data packet
Payload	~ 243 Bytes
Security	AES Encryption





Capas de LoRaWAN

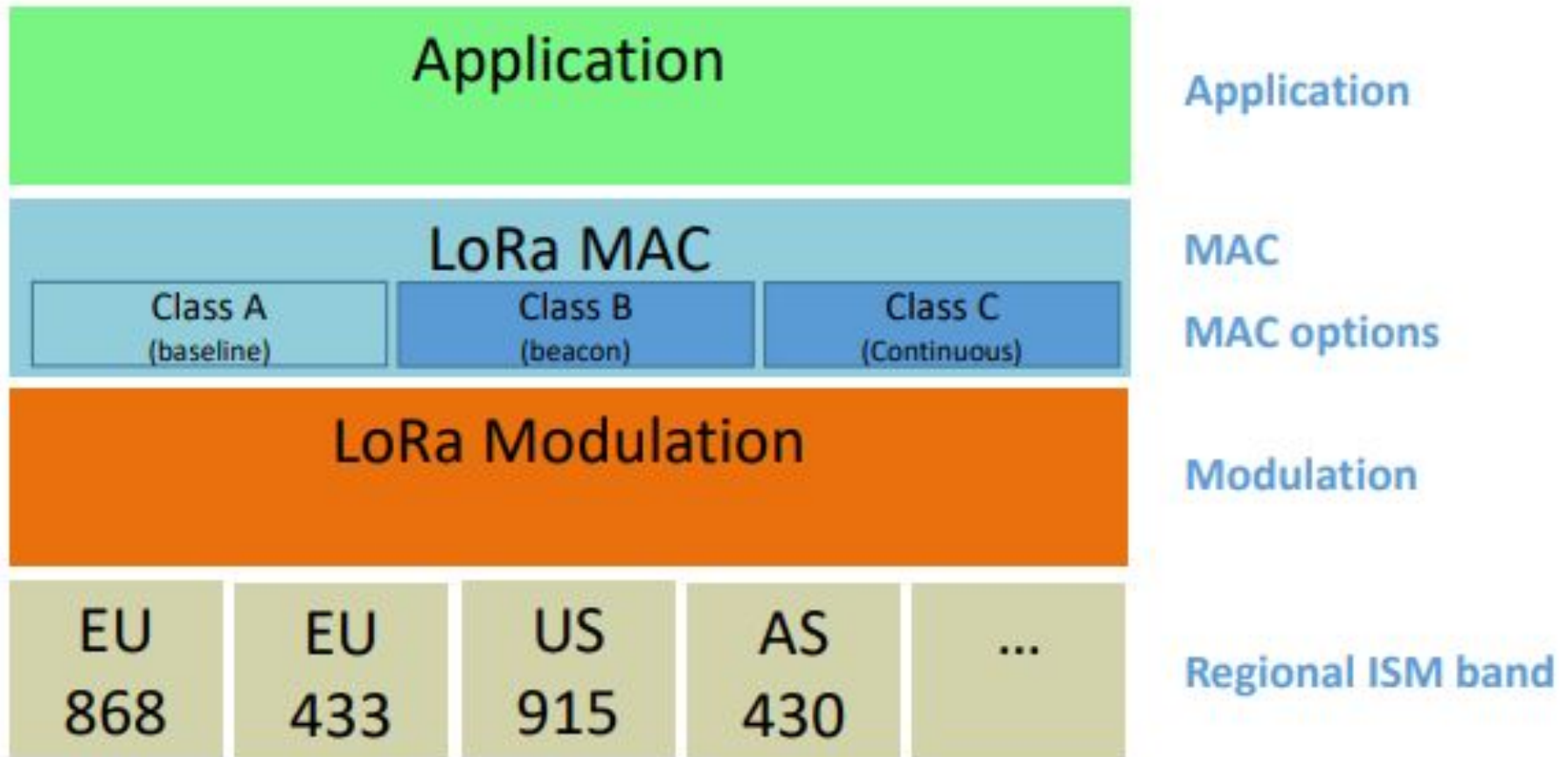



Capas de LoRaWAN

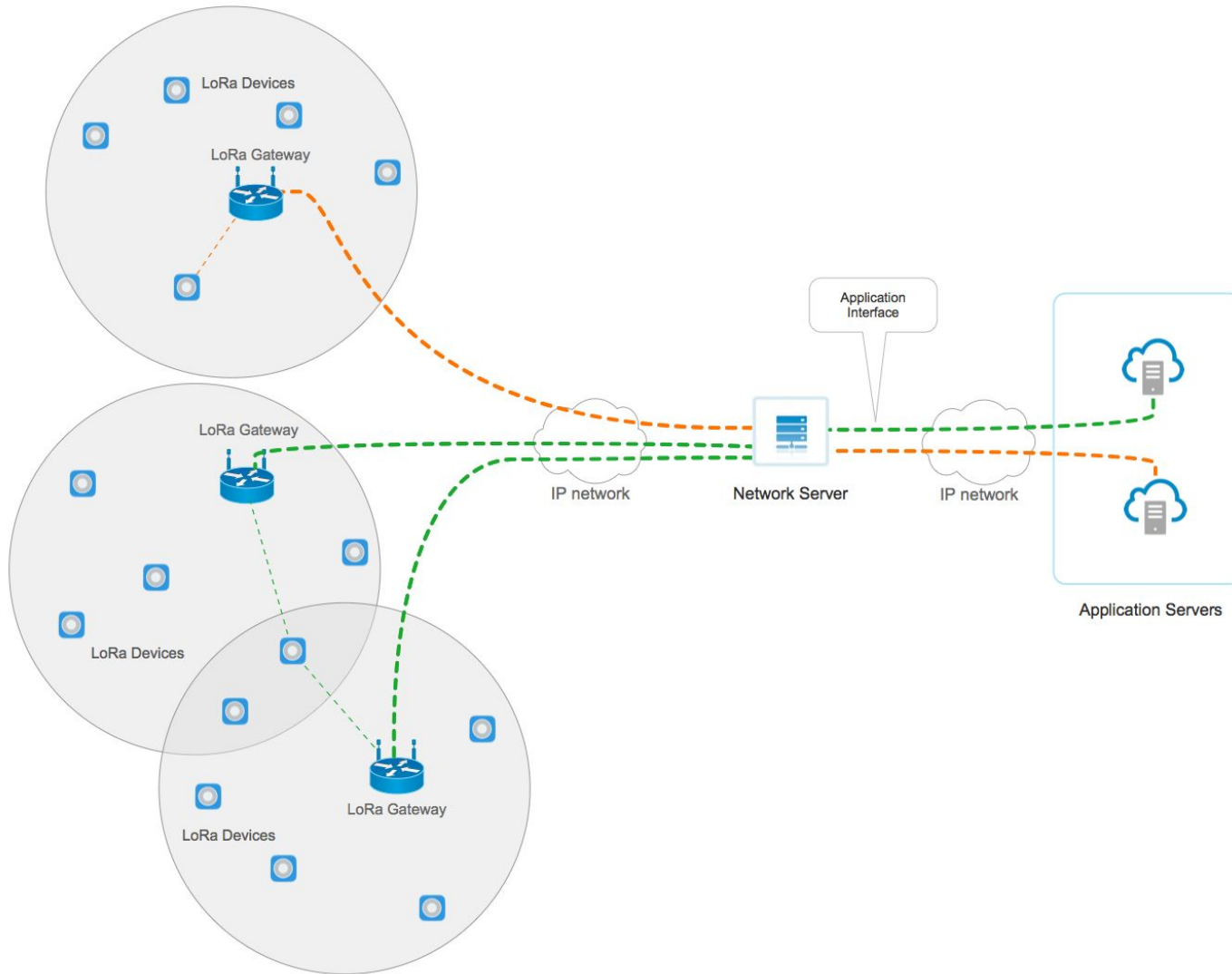



Capas de LoRaWAN

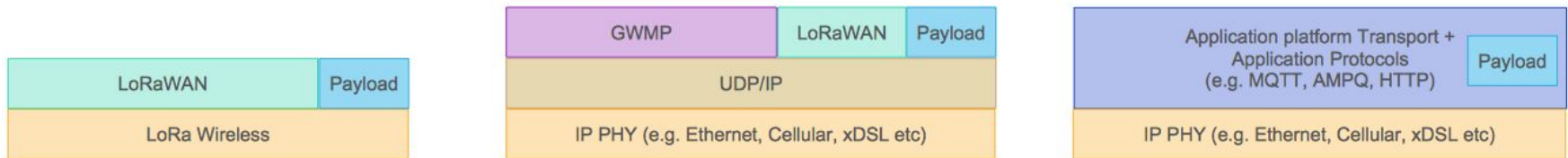

Device



LoRa Gateway



Network Server



Application Server

- LoRa corresponde únicamente a la capa física del enlace entre nodo y gateway.
- El estándar LoRaWAN especifica:
 - Capa MAC para el enlace nodo-gateway.
 - Capa de red/transporte para la comunicación entre nodo y servidor de red.



Nodos

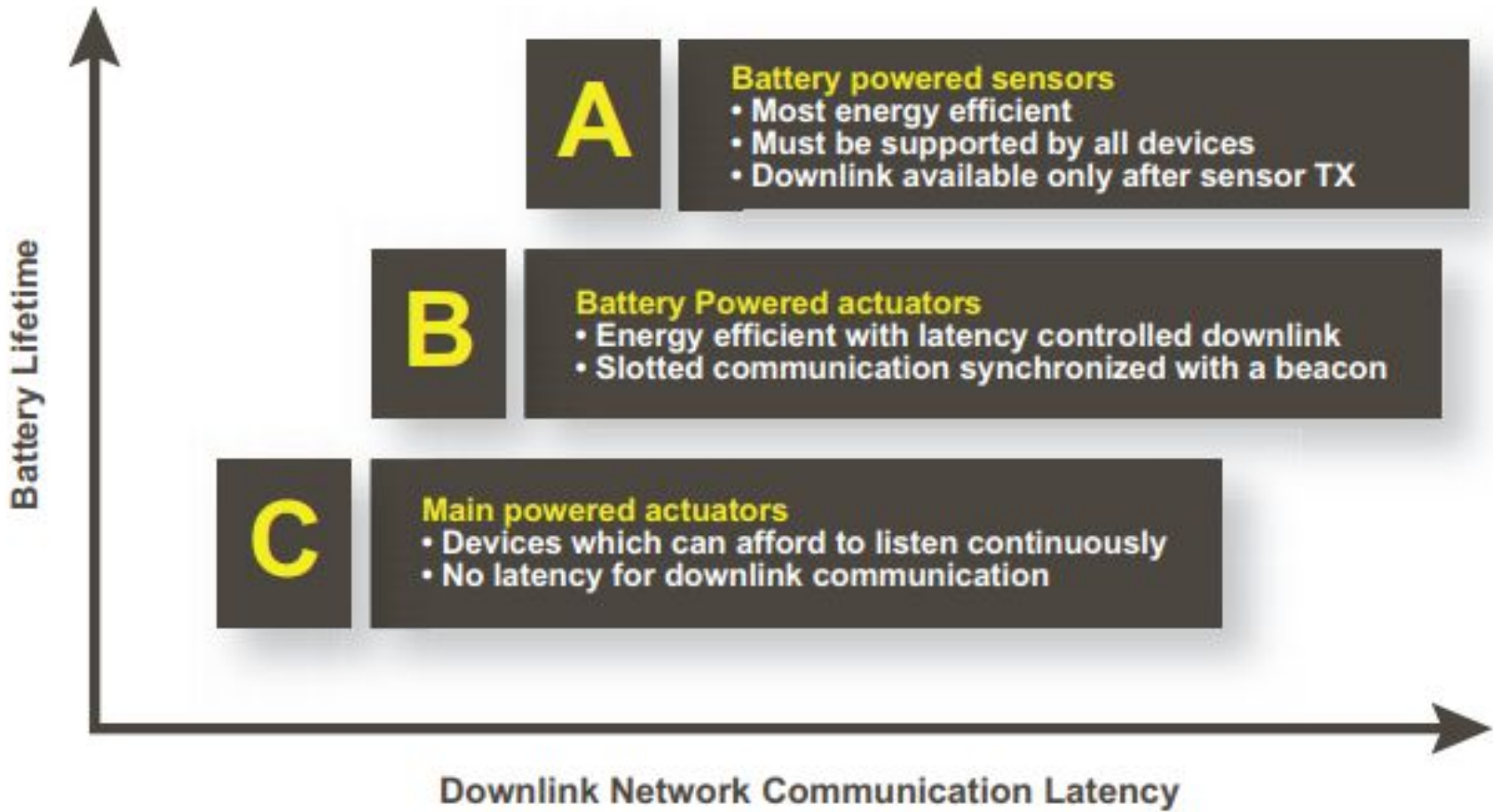



Nodos

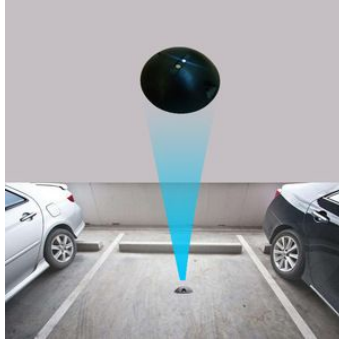



Nodos



- Sensores y/o actuadores de bajo consumo.
- Usan comunicación asíncrona con un esquema tipo ALOHA (cuando tienen algo para transmitir lo hacen).
- Los nodos deben soportar clase A.
- El soporte de clase B o C es opcional.
- Todas soportan comunicación bi-direccional.
- La diferencia está en:
 - latencia.
 - consumo de energía.



Nodos - Clase A

LoRaWAN Class A Devices

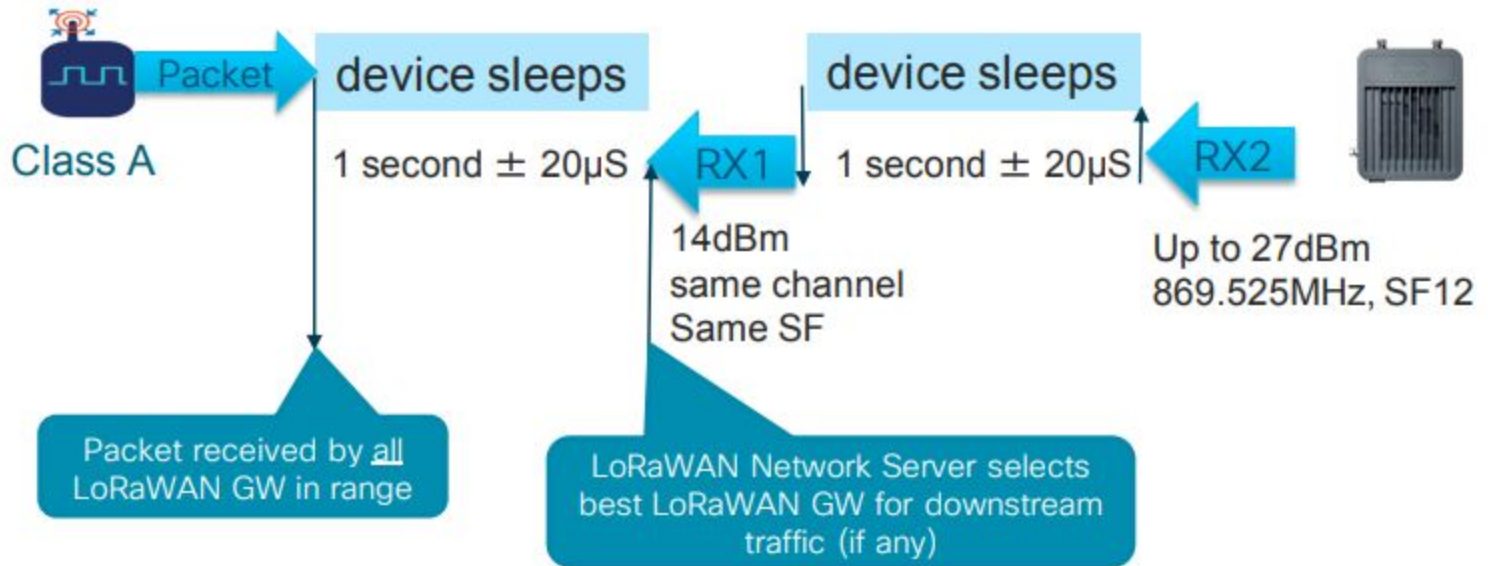

Class A: bi-directional (default: must be supported by all devices)

- Most energy efficient communication class
- Class A must initiate a Tx before listening on Rx windows
- Can switch to Class B or C





Nodos - Clase A

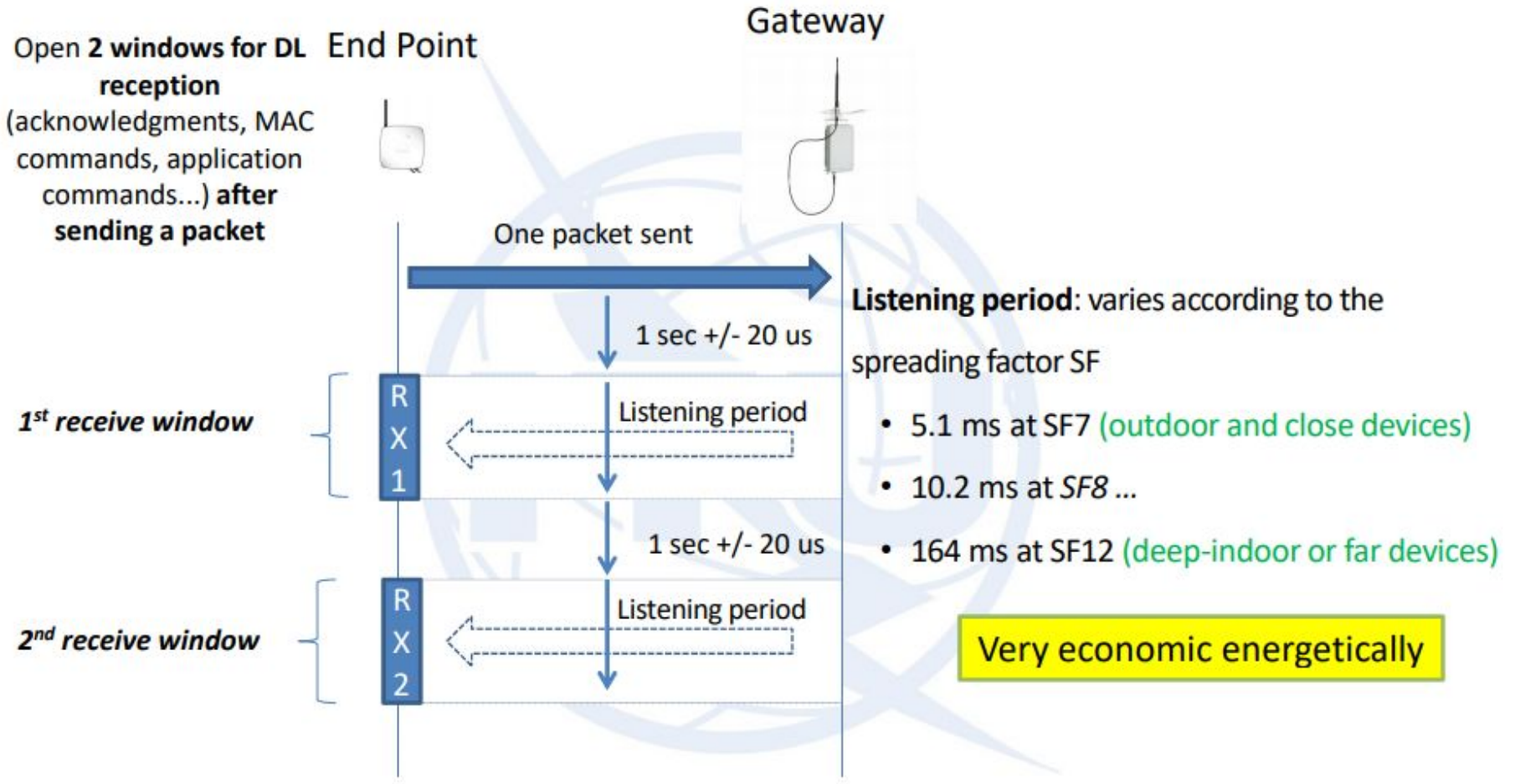



Nodos - Clase B

LoRaWAN Class B Devices

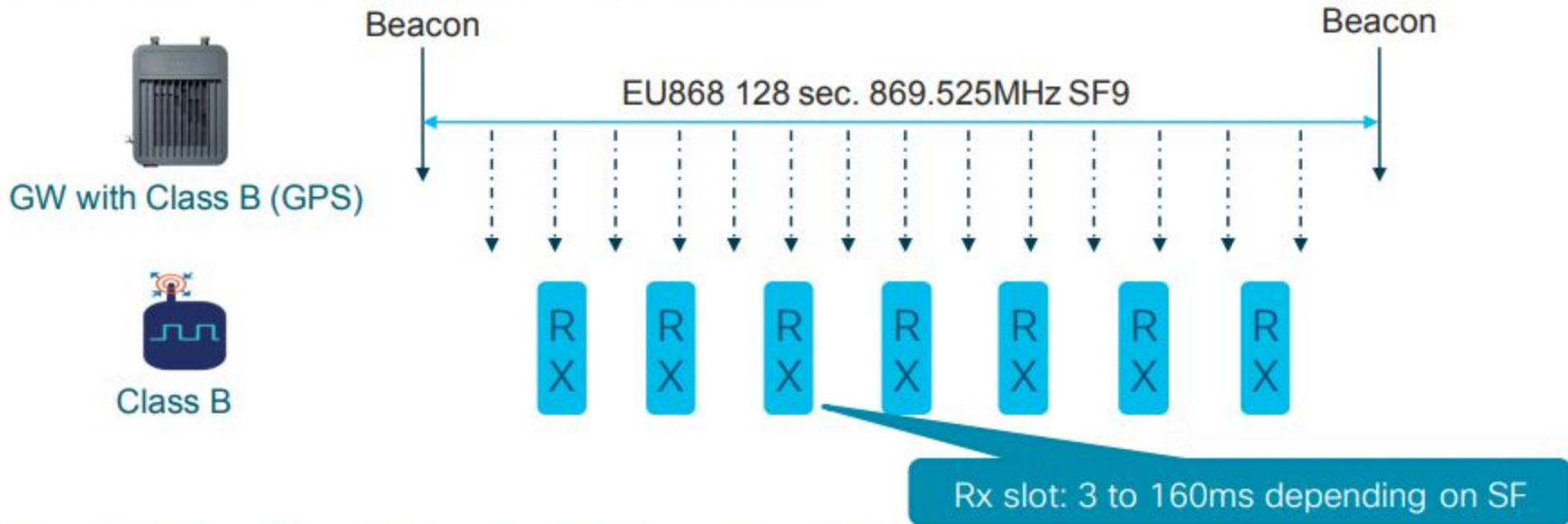

Class B Bi-directional with scheduled receive slots (Beacons)

- Energy efficient communication class for latency controlled downlink.
- Slotted communication synchronized with a network beacon (from gateways).
- Network may send downlink packet to node at any Rx slot
- Node may implements Class A, then switch to Class B, if application firmware supports it





Nodos - Clase B

- Synchronized with the GW
- Opens listening windows at regular intervals.

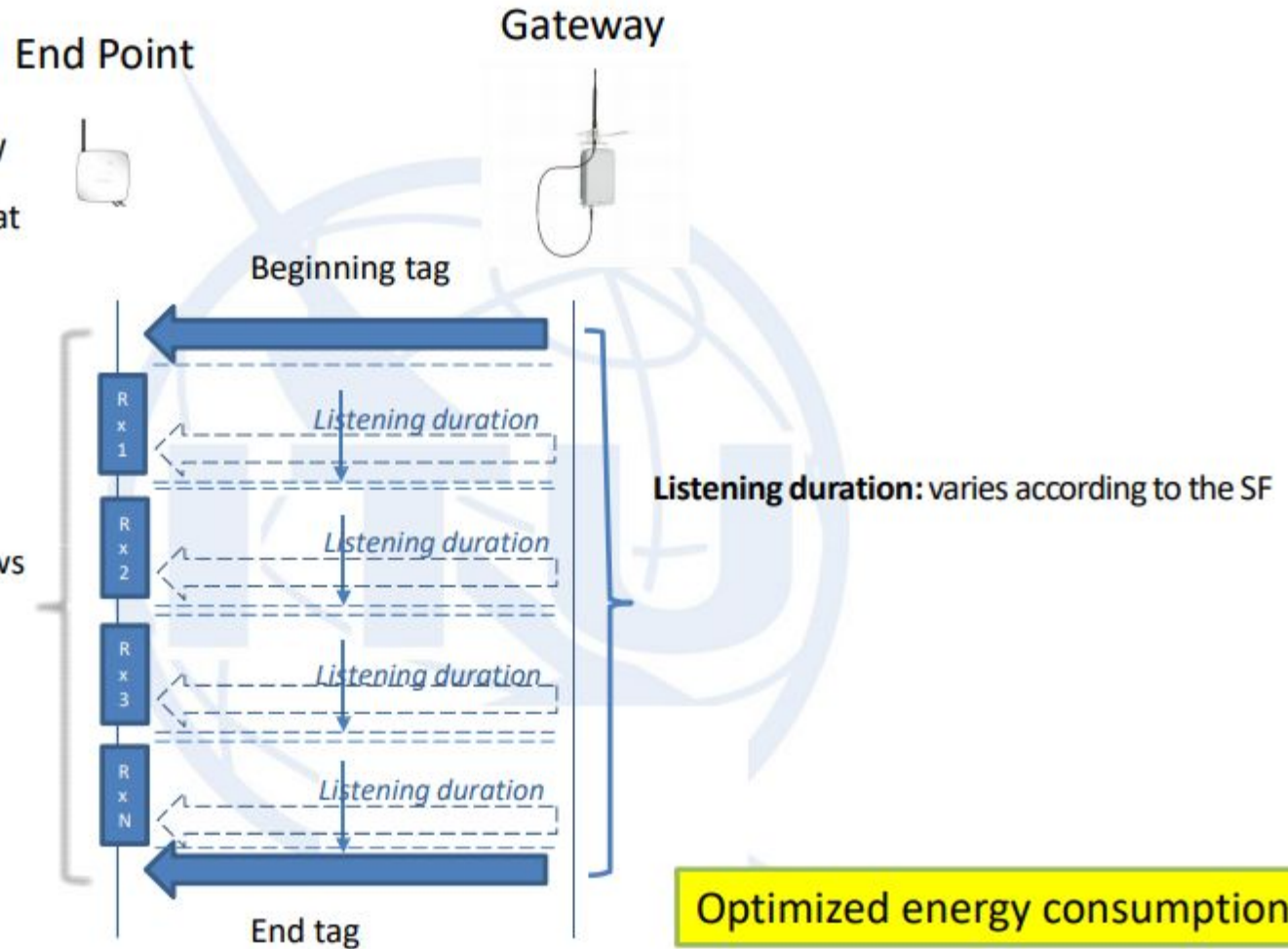

Opens N reception windows between the two tags

Listening duration: varies according to the SF

Optimized energy consumption





Nodos - Clase C

LoRaWAN Class C Devices

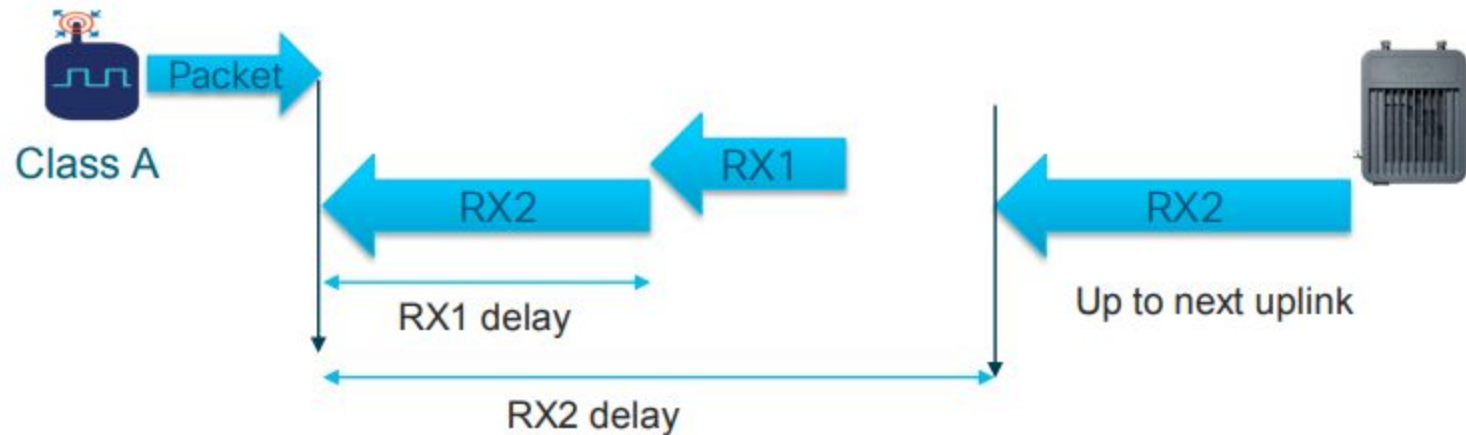

Class C: bi-directional with “Continuous Rx”

- Powered devices which can afford to listen continuously.
- No latency for downlink communication.
- Implements Class A RX1 window plus...Continually listens on RX2 channel, only closed when Transmitting



Nodos - Clase C

- **Permanent listening**
- Closes the reception window only during transmissions

Reception window always open

Closed receive window

Reception window is open

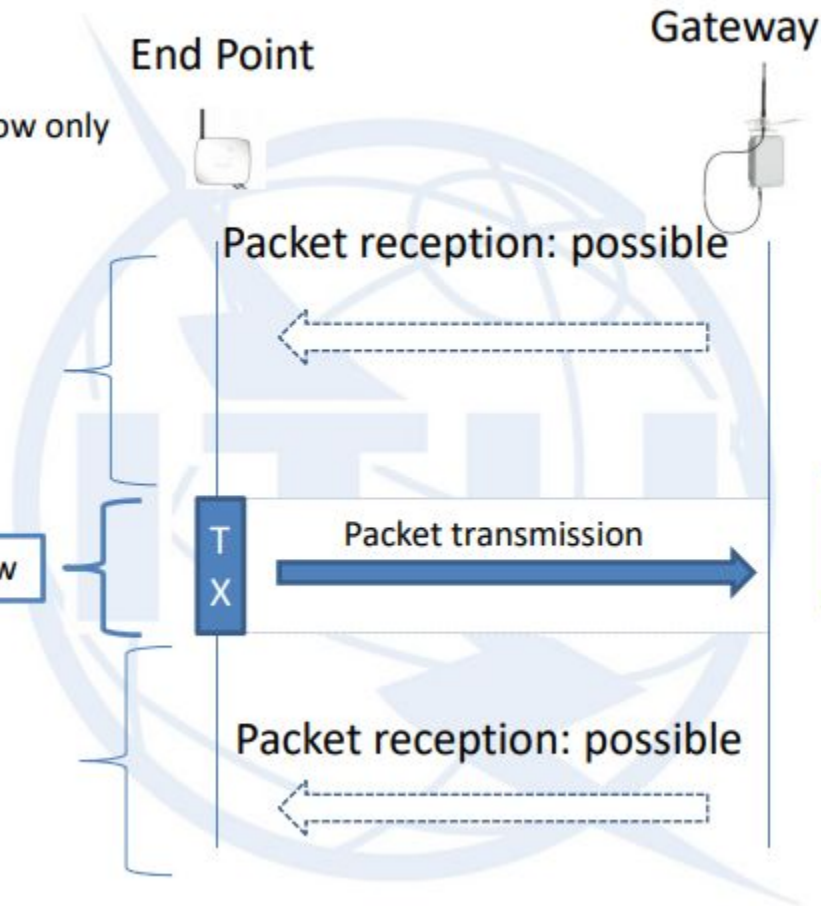

Adapted to devices on the power grid





Resumen de nodos

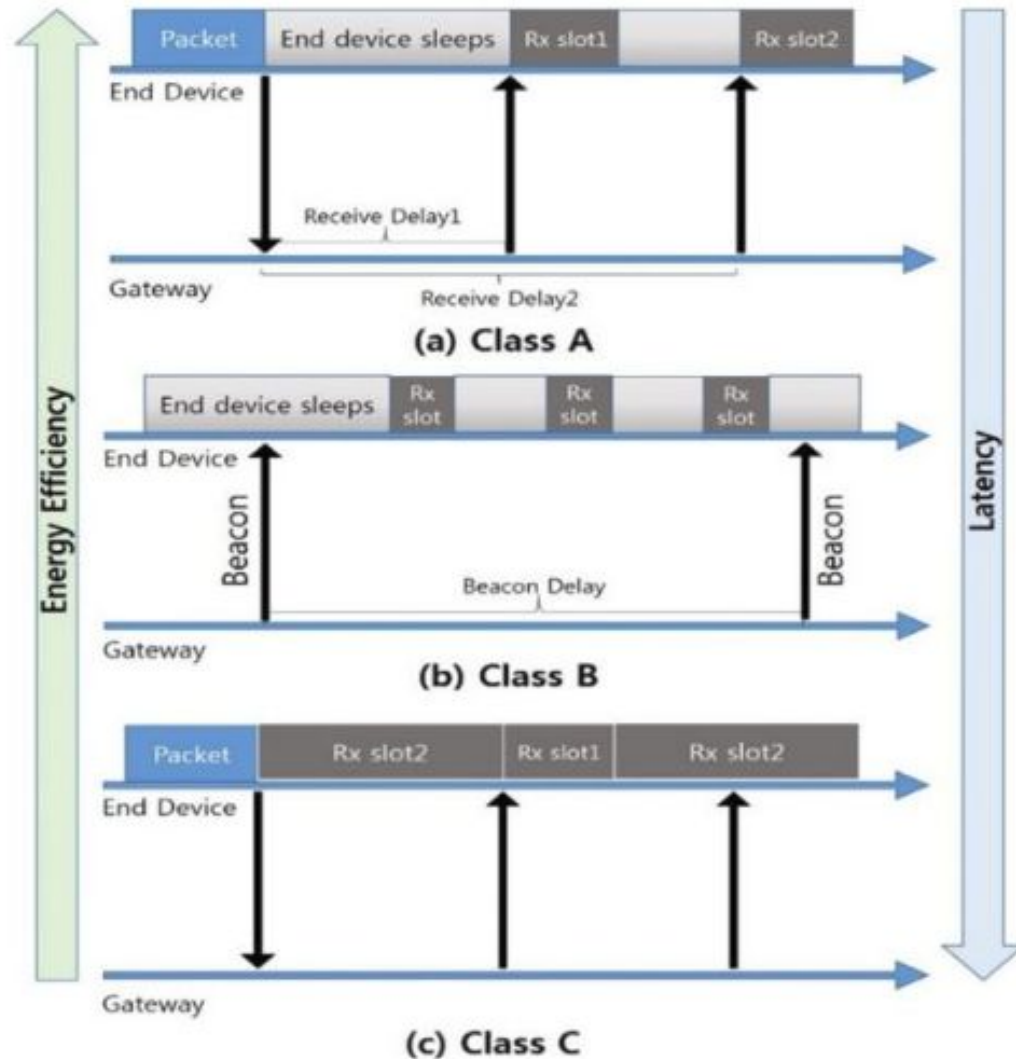



Gateways



- Son el equivalente a las radiobases en redes celulares o los APs en redes Wi-Fi.
- Actúan como concentradores, reenviando los paquetes de los nodos al servidor de red.
- La interfaz con los nodos es inalámbrica, a través de la capa física LoRa.
- La interfaz con el servidor de red es una conexión IP (3G/4G, Ethernet o fibra).
- Múltiples gateways pueden recibir el mismo paquete de cierto nodo (cobertura solapada).





Gateways





Tipos de gateways



- Al igual que radiobases o APs, los gateways pueden ser para interior o exterior.
- SCG (Single-Channel Gateways): solamente pueden recibir paquetes en un canal y un SF a la vez. No cumplen con estándar LoRaWAN.
- MSG (Multiple-Channel Gateways): pueden escuchar y recibir paquetes en diversos canales simultáneamente (típicamente 8), incluso con distintos SF y rates.



Network server



- Entidad centralizada que gestiona toda la red.
- Tareas del servidor de red:
 - Filtra paquetes duplicados (recibidos por múltiples gateways).
 - Realiza el chequeo de seguridad.
 - Envía ACK a los gateways.
 - Adaptative Data Rate (ADR).
 - Ruteo de paquetes, selección de GW.



Network server



LORIoT



orbiwise



THE THINGS NETWORK



LoRaServer



ChirpStack



THE THINGS STACK



senet

Connecting the IoT Revolution



ResIoT



everynet



Actility

Connecting with intelligence

MACHINE Q™
A COMCAST COMPANY



ThingPark
by actility
Making Things Smart





Historia de LoRaWAN



- LoRa Alliance y primer estándar
 - Creado por empresas diversas de la industria.
 - Versión 1.0 liberada en Junio de 2015.
 - Estándar abierto (similar a 802.11).
- Actualmente dos versiones 1.0.X (más nueva es 1.0.4) y 1.1 (agrega roaming entre redes).
- Documentos principales:
 - LoRaWAN specification.
 - LoRaWAN regional parameters.





Bandas de frecuencia US902-928

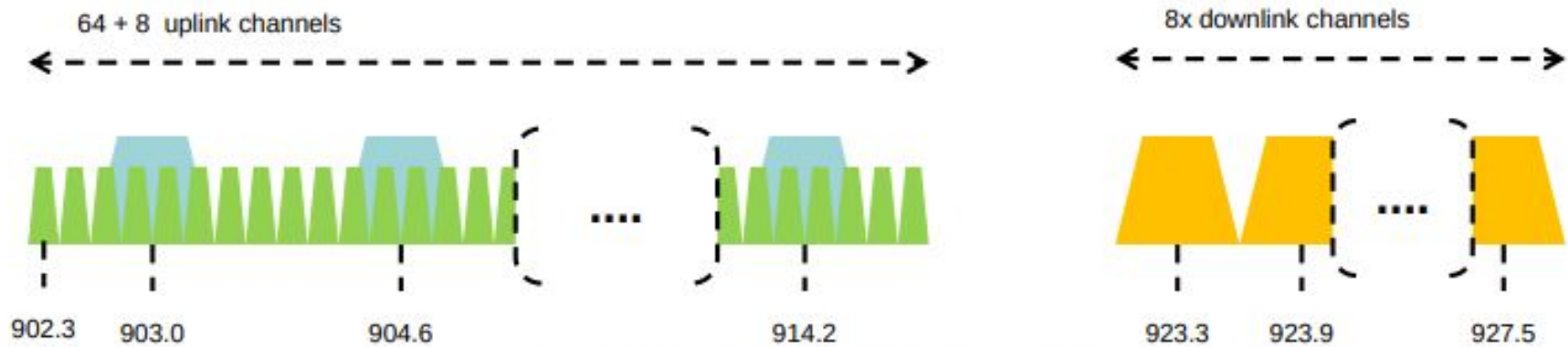

Figure 1: US902-928 channel frequencies



Bandas de frecuencia AU915-928

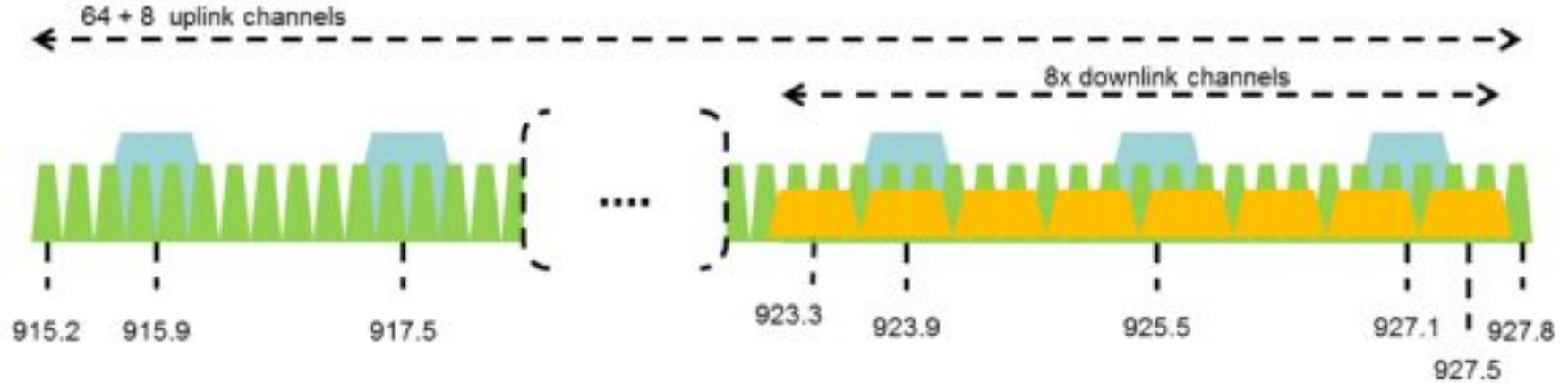

Figure 2: AU915-928 channel frequencies



Datarates - AU915-928

DataRate	Configuration	Indicative physical bit rate [bit/sec]
0	LoRa: SF12 / 125 kHz	250
1	LoRa: SF11 / 125 kHz	440
2	LoRa: SF10 / 125 kHz	980
3	LoRa: SF9 / 125 kHz	1760
4	LoRa: SF8 / 125 kHz	3125
5	LoRa: SF7 / 125 kHz	5470
6	LoRa: SF8 / 500 kHz	12500
7	RFU	
8	LoRa: SF12 / 500 kHz	980
9	LoRa: SF11 / 500 kHz	1760
10	LoRa: SF10 / 500 kHz	3900
11	LoRa: SF9 / 500 kHz	7000
12	LoRa: SF8 / 500 kHz	12500
13	LoRa: SF7 / 500 kHz	21900
14..15	RFU	

Table 35: AU915-928 Data rate table





Capa física (RF)

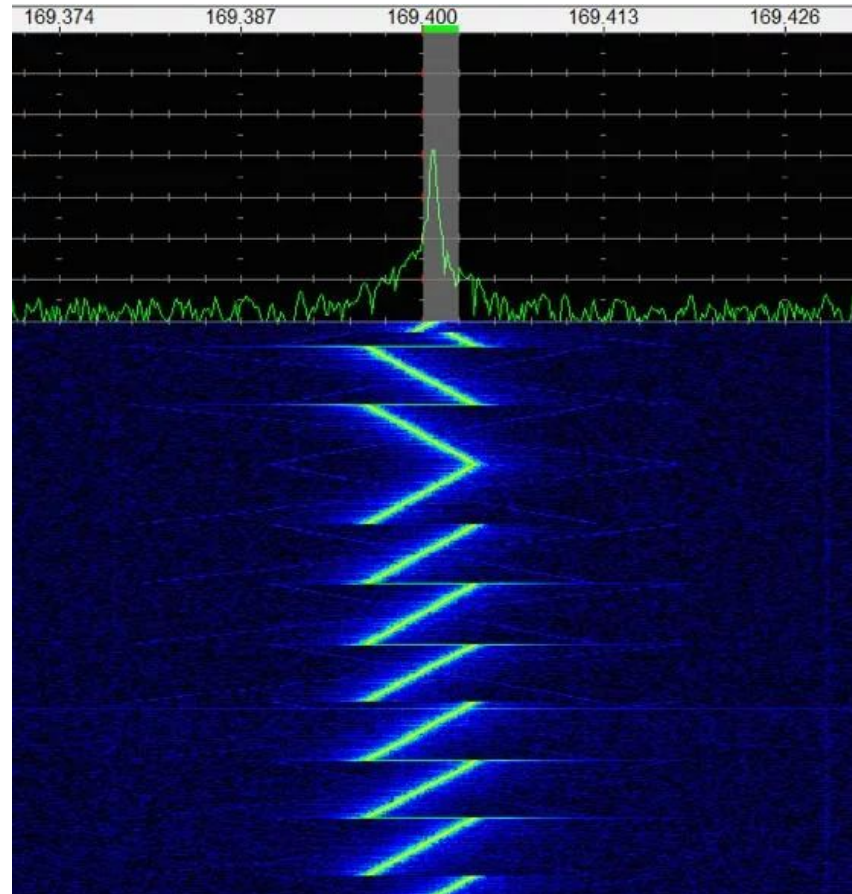

- CSS: Chirp Spread Spectrum



Capa física (RF)



- Spreading Factor (SF)

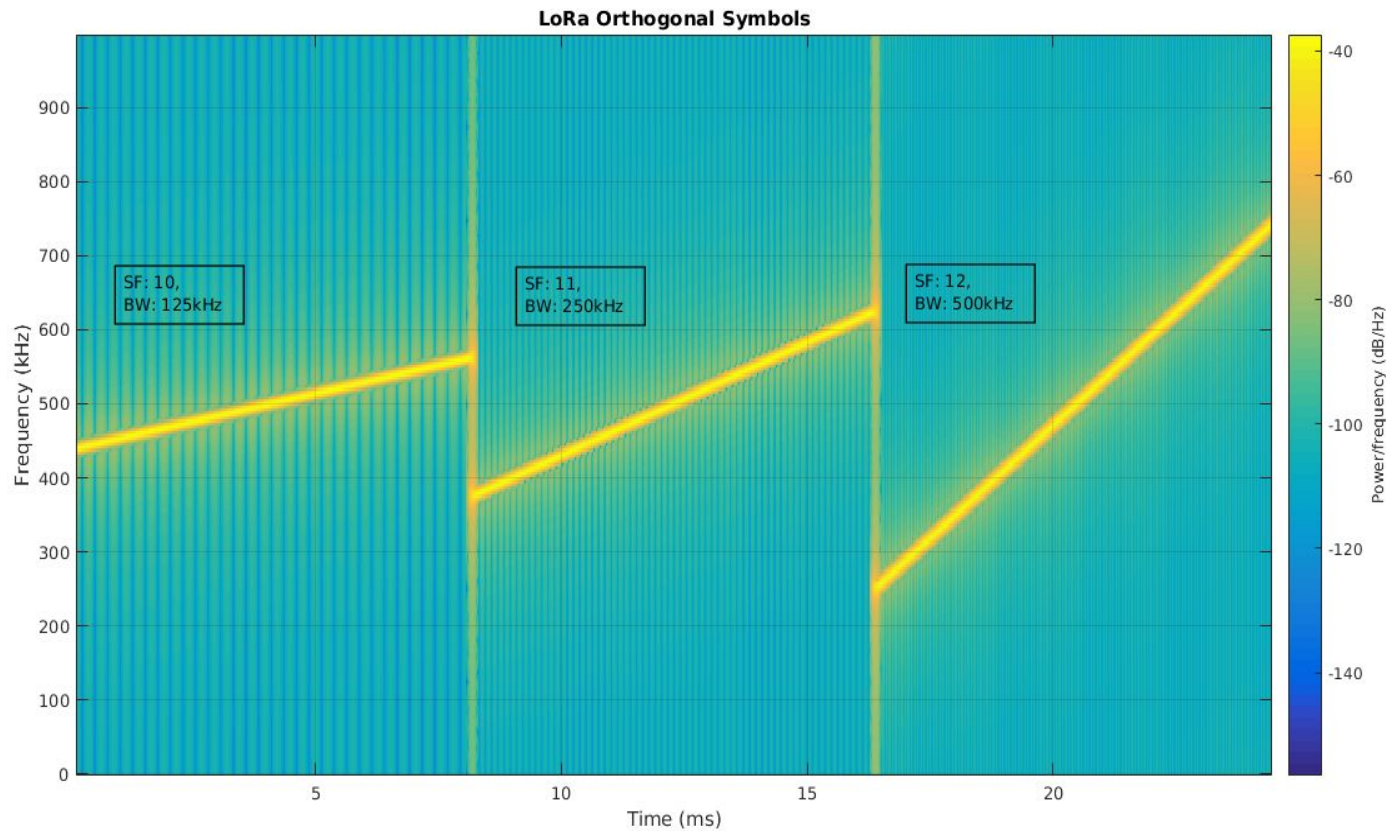



Capa física (RF)



Table 3: Semtech SX1276 LoRa receiver sensitivity [dBm] [24].

SF BW	6	7	8	9	10	11	12
125kHz	-118	-123	-126	-129	-132	-133	-136
250kHz	-115	-120	-123	-125	-128	-130	-133
500kHz	-111	-116	-119	-122	-125	-128	-130





Capa física (RF)

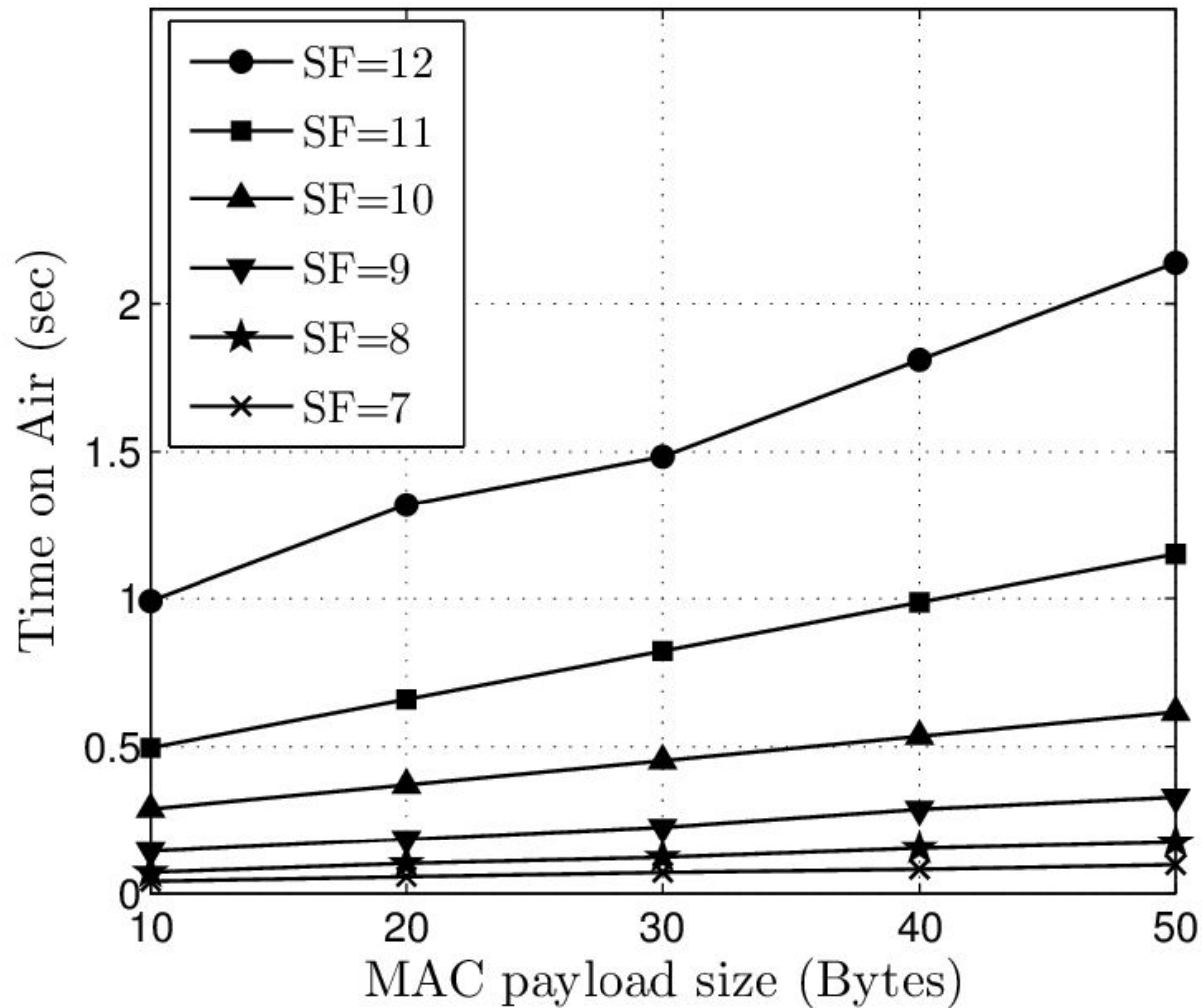



Acceso al medio (MAC)



- Está basado en ALOHA y por tanto muy eficiente desde el punto de vista del consumo.
- Se reducen paquetes del plano de control y permite nodos asíncronos.
- Problema: no escala bien.
- A medida que aumenta la cantidad de nodos tratando de transmitir simultáneamente, también aumenta el tiempo para lograrlo.
- Potencial problema en “horas pico”.



Acceso al medio (MAC)

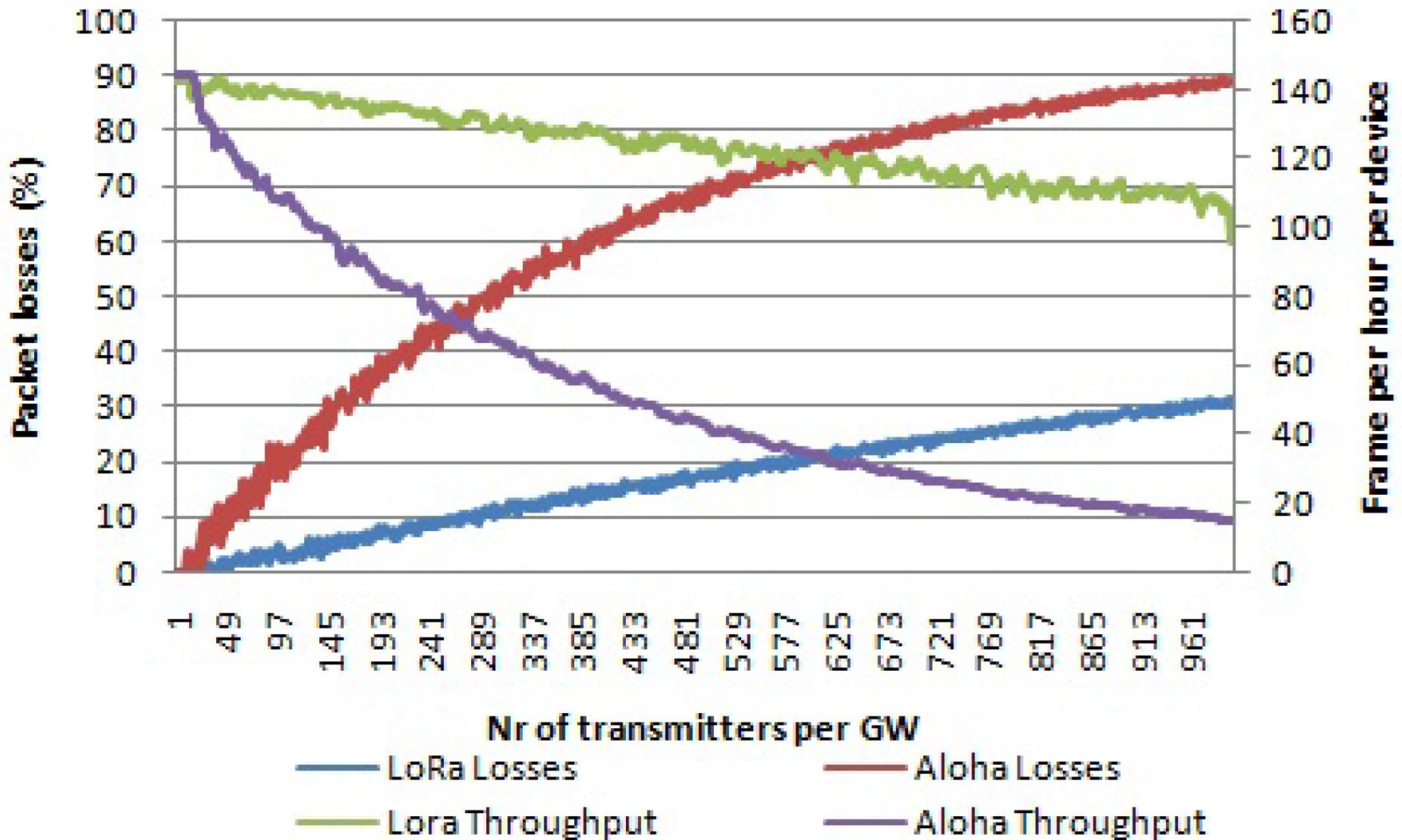



Estructura de trama

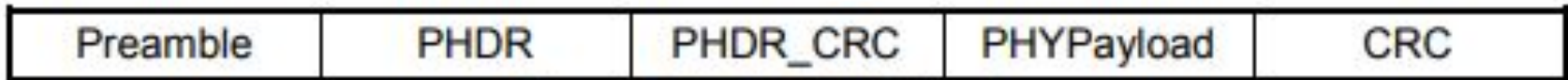

Figure 2: Uplink PHY structure



Figure 3: Downlink PHY structure

- Preámbulo: sincronismo en tiempo y frecuencia.
- PHDR y PHDR_CRC: encabezado PHY y su correspondiente CRC.
- PHYPayload: carga útil de capa física.
- CRC: protección de integridad del payload.



Tipos de tramas

MType	Description
000	Join-request
001	Join-accept
010	Unconfirmed Data Up
011	Unconfirmed Data Down
100	Confirmed Data Up
101	Confirmed Data Down
110	Rejoin-request
111	Proprietary

Table 1: MAC message types

- 4 tipos para datos (Up y Down, con y sin ACK).
- 3 para activación vía OTAA.



Estructura de trama

Radio PHY layer:

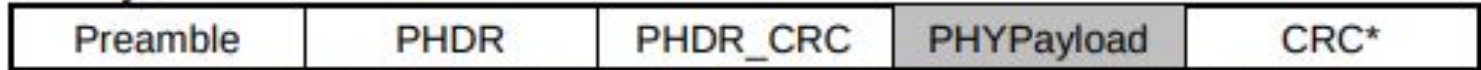

Figure 5: Radio PHY structure (CRC* is only available on uplink messages)

PHYPayload:

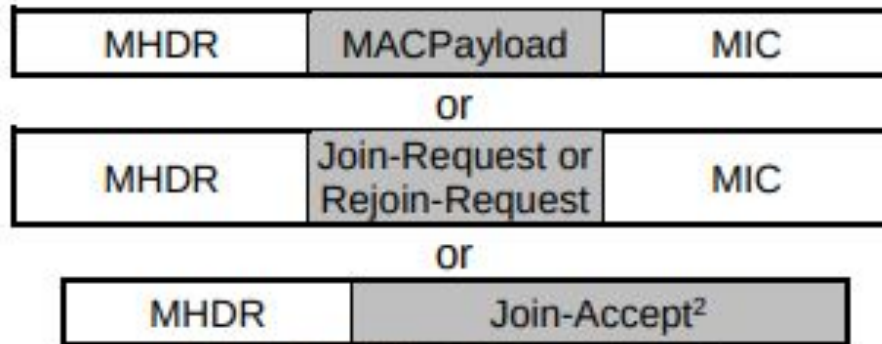

Figure 6: PHY payload structure

MACPayload:



Figure 7: MAC payload structure

FHDR:

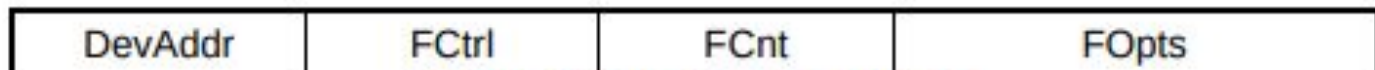

Figure 8: Frame header structure





Estructura de trama



- MHDR (MAC header) especifica el tipo de mensaje y la versión de LoRaWAN.
- MAC Payload tiene el frame header (FHDR) seguido de un campo opcional con el puerto (FPort) y otro campo opcional de payload de la trama (FRMPayload).
- El largo del payload de capa MAC Payload es variable, ya que depende del data rate que se esté utilizando.



Estructura de trama



- FHDR contiene la dirección del nodo(DevAddr), una trama de control 8 bits (FCtrl) para el ADR (Adaptive Data Rate), dos octetos de para el contador de tramas(FCnt), y hasta 15 octetos de opciones de trama(FOpts) utilizados por los comandos MAC.
- MIC (Message Integrity Code) autentica cada mensaje con el servidor de red LoRaWAN.



Estructura de trama

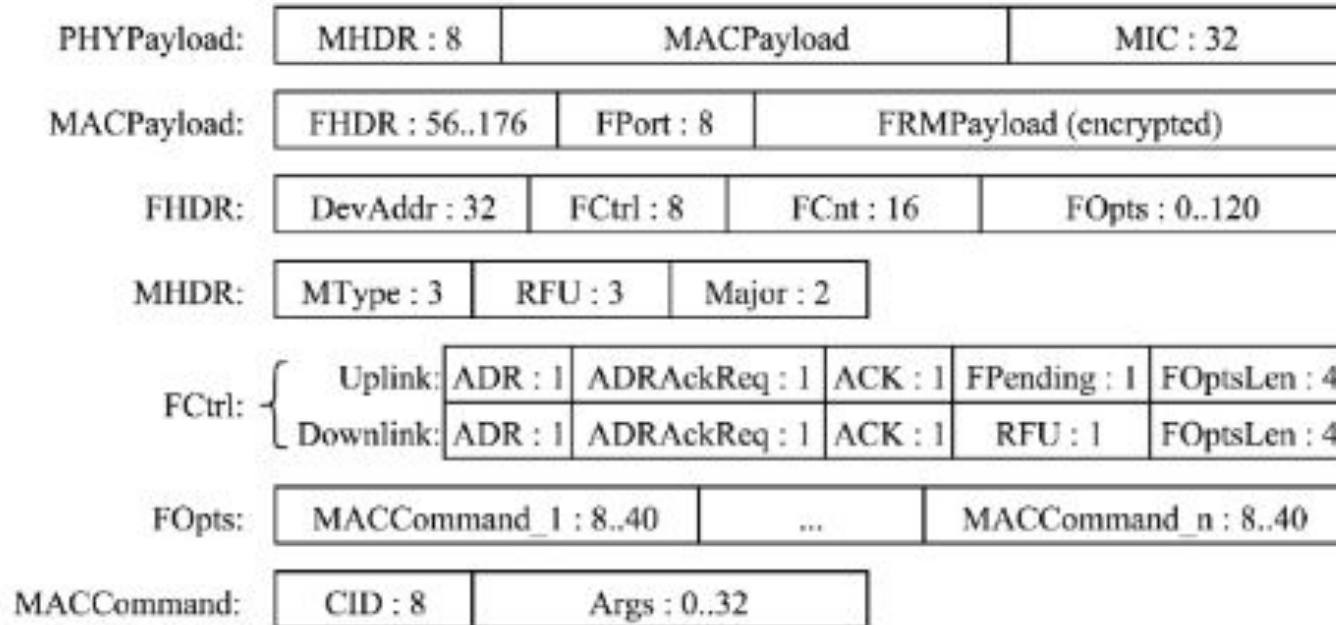

Figure 3.10 – LoRaWAN frame format. The sizes of the fields are in bits [33]



Configuración de nodo



- Para la conexión vía LoRaWAN se debe definir en qué frecuencias va a transmitir/escuchar.
- Es posible cambiar la potencia de transmisión.
- Es necesario activar el dispositivo en la red, para lo cual existen dos mecanismos:
 - ABP - Activation by personalization.
 - OTAA - Over the air activation.
- En ambos casos, es necesario cargar cierta información en el nodo previamente.



Aprovisionamiento



- DevEUI (IEEE EUI64) - Identificador global del nodo, análogo a dirección MAC en red TCP/IP.
- Es el identificador recomendado para que el servidor de red identifique a los nodos, sea cual fuere el mecanismo de activación.
- Dispositivos OTAA - deben tenerlo almacenado previo a poder asociarse.
- Para ABP no se requiere tenerlo almacenado, pero se recomienda que también lo tengan.



Aprovisionamiento



- End-device address (DevAddr): Identificador de 32 bits del nodo en la red.
- Siete bits se utilizan como identificador de la red, y los restantes 25 bits corresponden a la dirección de red del nodo.
- Comparable con una dirección IP para un dispositivo TCP/IP.



Aprovisionamiento



- AppEUI/JoinEUI (IEEE EUI64) - Identificador global de la aplicación que identifica al Join Server que asiste en el proceso de asociación y generación de claves de sesión.
- Dispositivos OTAA - deben tenerlo almacenado previo a poder asociarse.
- No se requiere para dispositivos que únicamente soportan ABP.



Configuración de nodo



- Network session key (NwkSKey): clave AES de 128 bits usada para la autenticación entre servidor de red y nodo, y para calcular y verificar el MIC de todos los mensajes y asegurar la integridad de los datos.
- Application session key (AppSKey): clave AES de 128 bits usada por el servidor de red y los nodos para encriptar/desencriptar el payload de todos los mensajes de datos.



Aprovisionamiento vía ABP

ABP: Activation By Personalisation

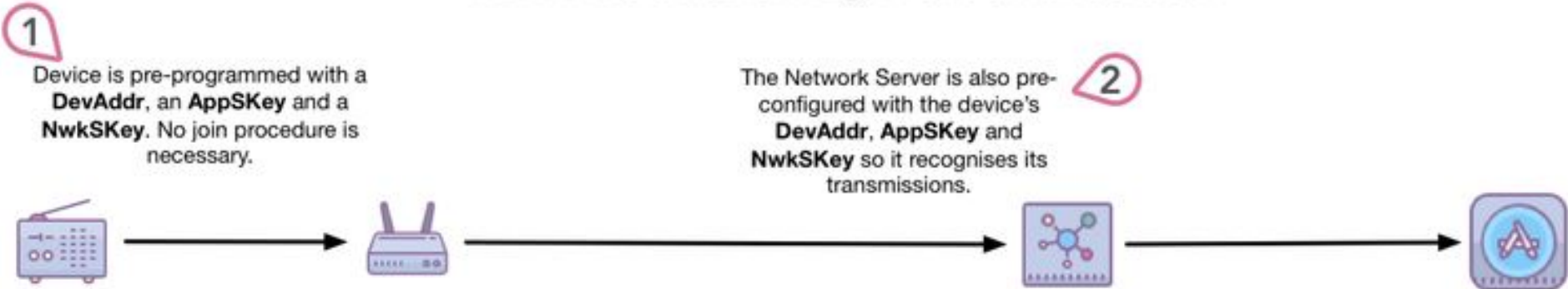



Aprovisionamiento vía ABP

LoRaWAN Activation-By-Personalisation (ABP)

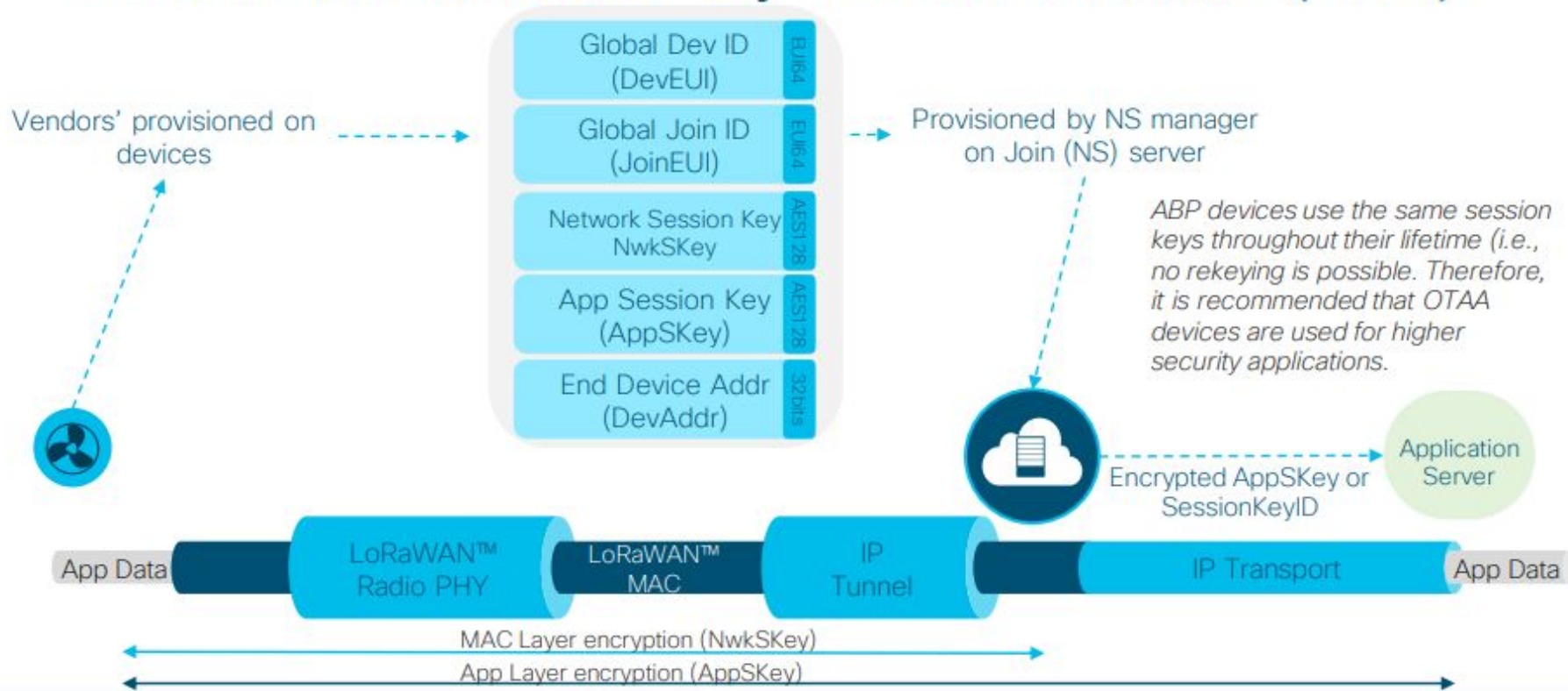



Aprovisionamiento vía OTAA

OTAA: Over-The-Air Activation

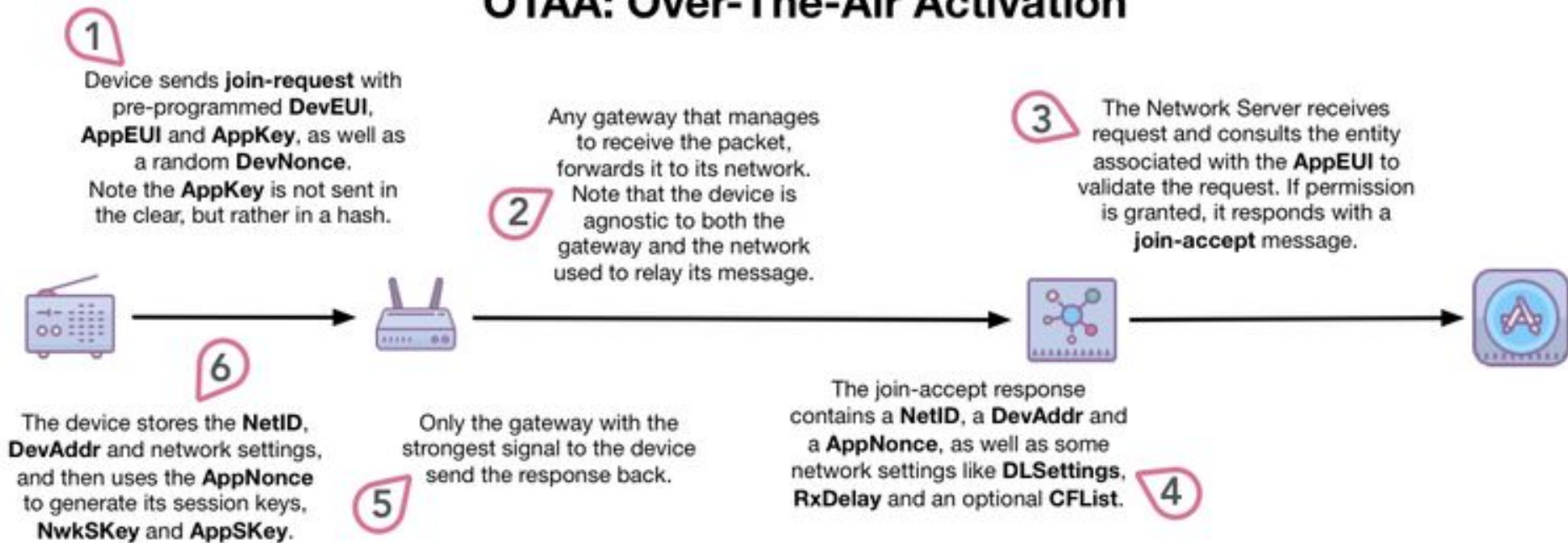



Aprovisionamiento vía OTAA

LoRaWAN Over-The-Air Activation (OTAA)

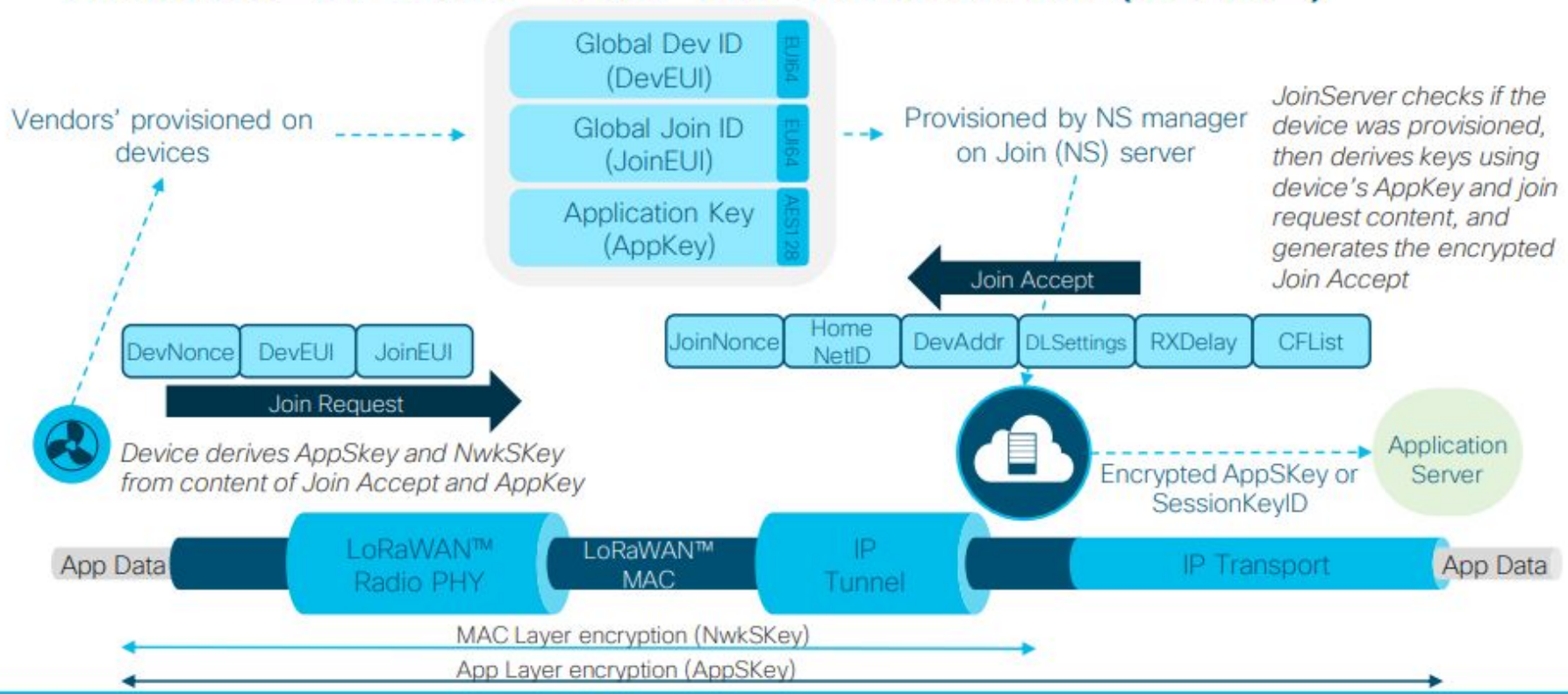



Seguridad

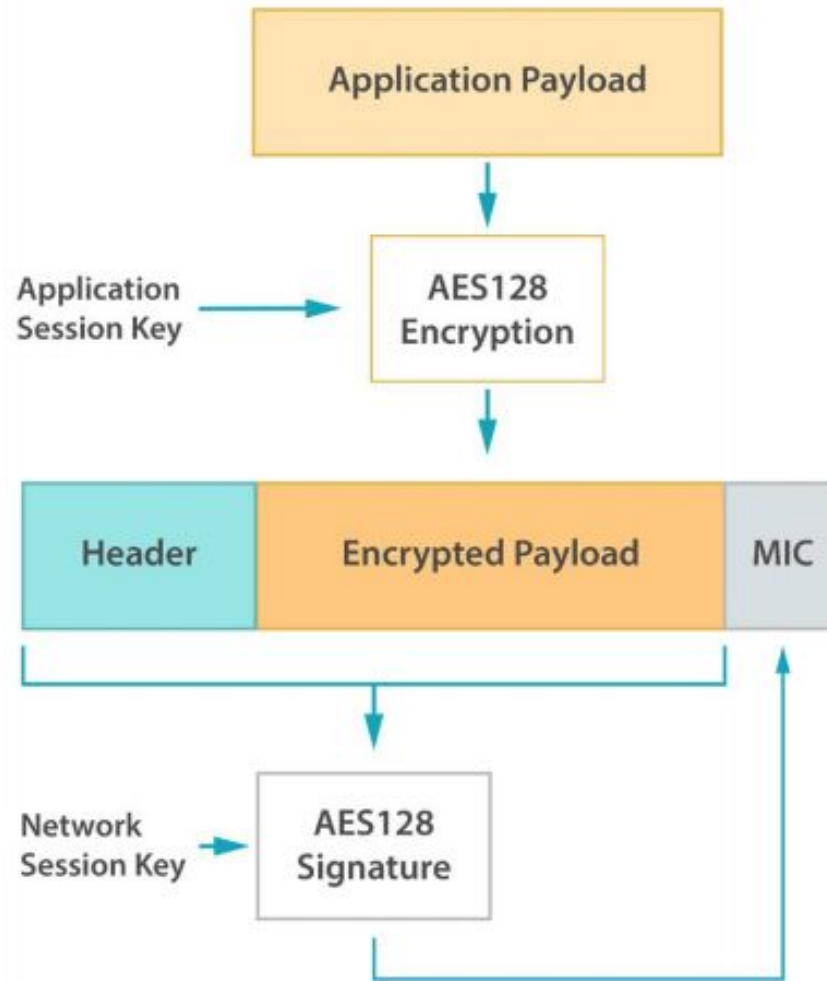



Seguridad

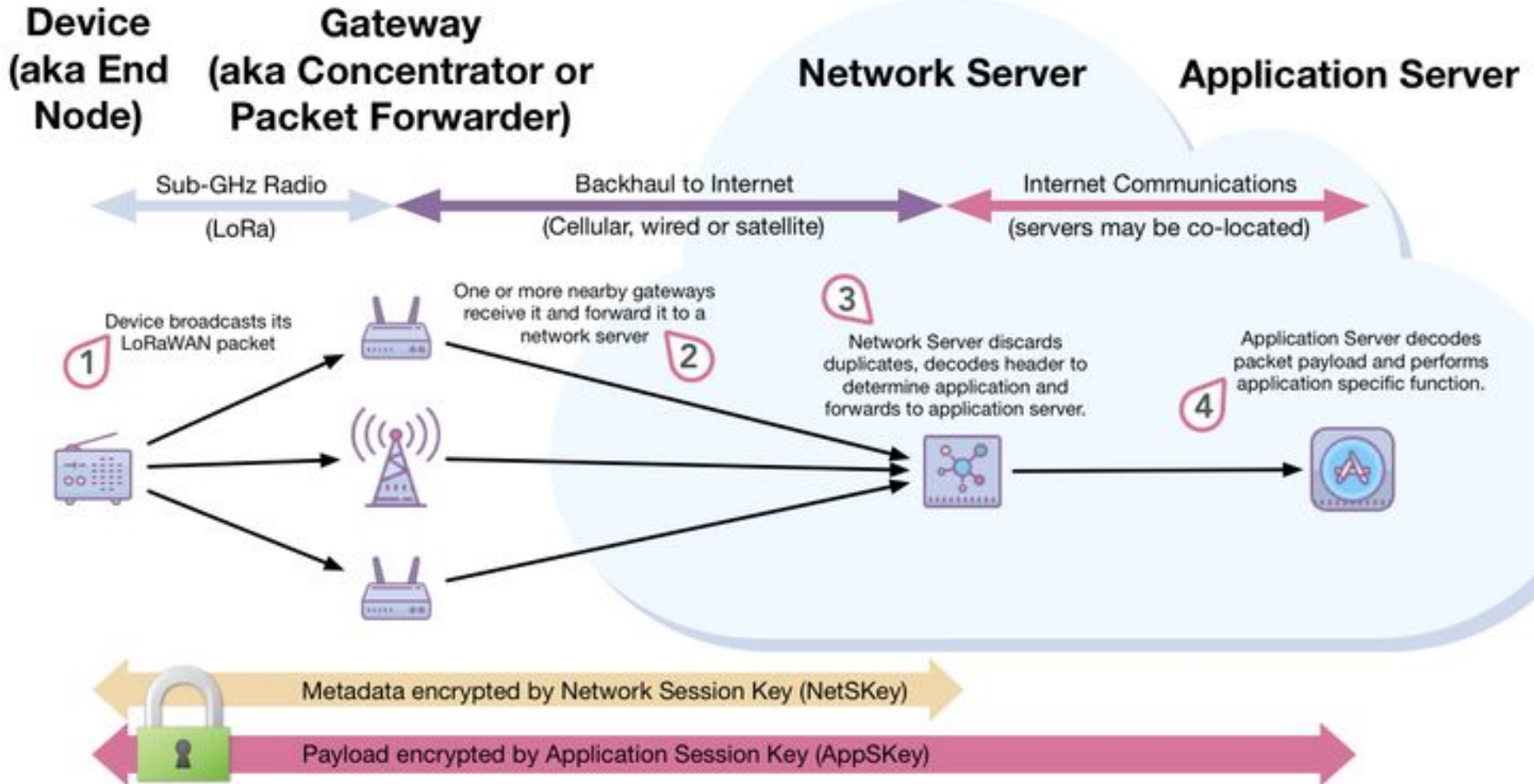

Tasa de datos adaptiva (ADR)



LoRaWAN Adaptive Data Rate (ADR)

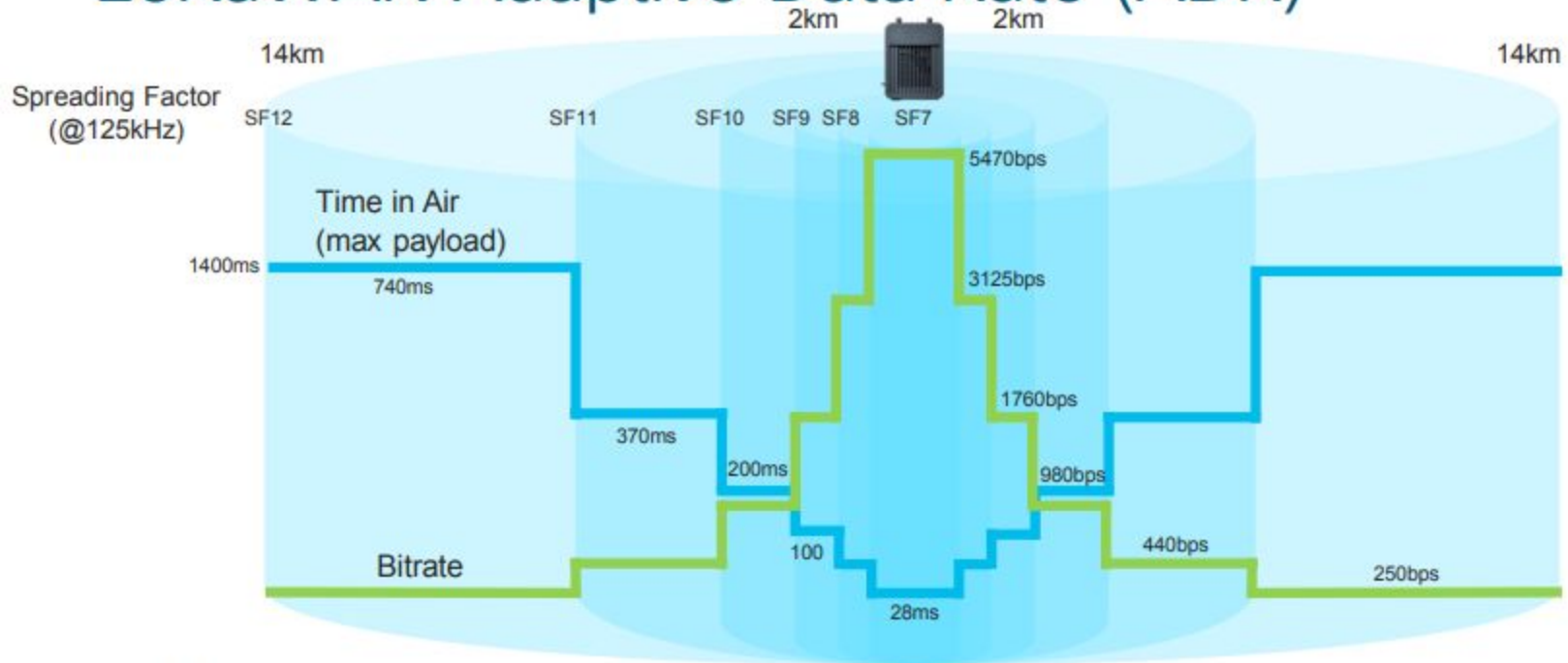

- ADR maximises battery life overall & network capacity
- ADR manages the data rate and RF output for each device



Tasa de datos adaptativa (ADR)



ADR, Spreading Factor and Payload

Spreading Factor	Data Rate (bit/s)	Time on Air (ms)	Maximum Payload Size	End-device sensitivity (dBm)
SF12	250	1400	59 bytes	-137
SF11	440	740	59 bytes	-135
SF10	980	370	59 bytes	-133
SF9	1760	200	123 bytes	-130
SF8	3125	100	250 bytes	-127
SF7	5470	28	250 bytes	-124





Geolocalización

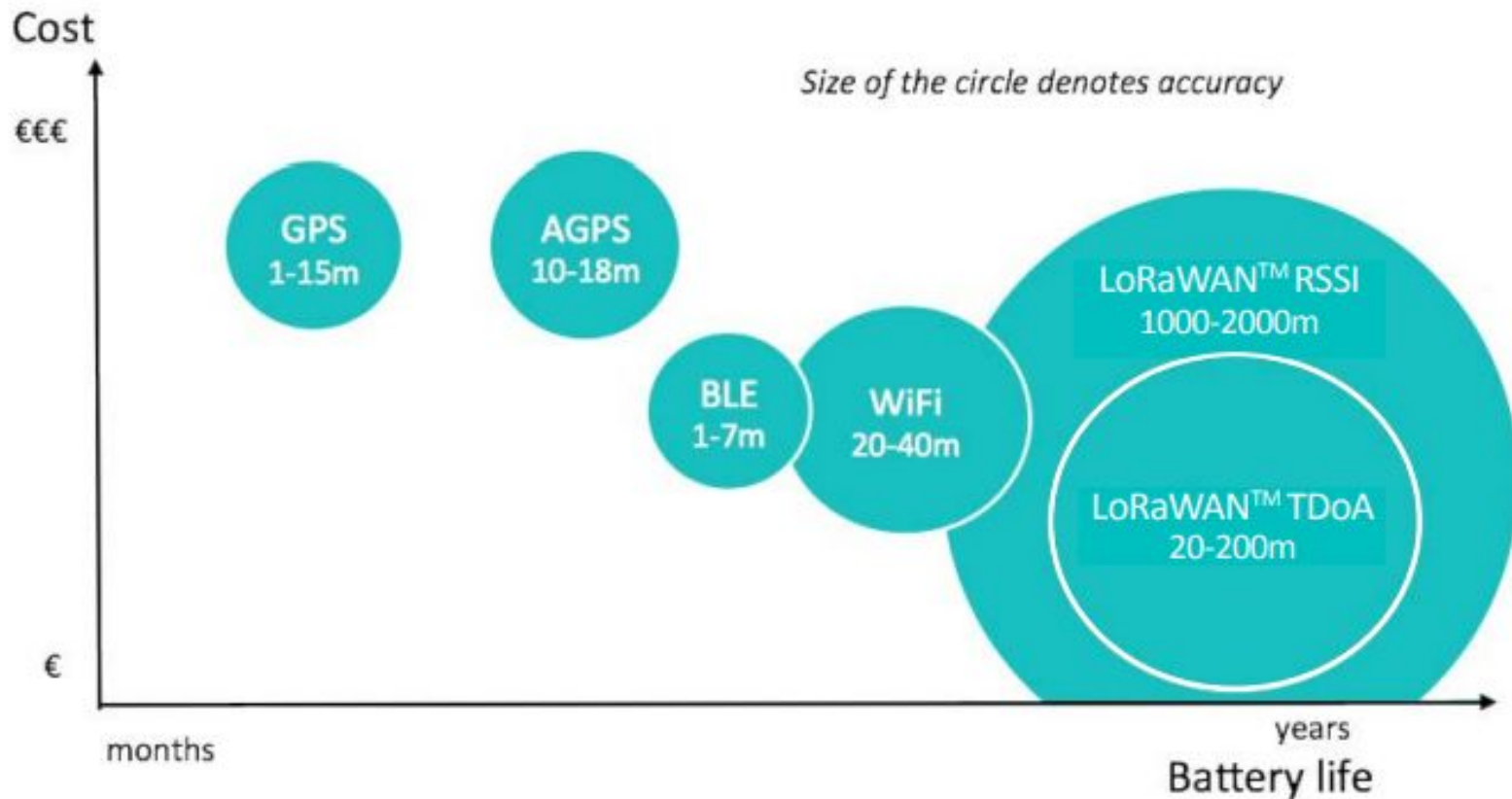

- Solución de bajo costo soportada para cualquier sensor (GWs deben estar localizados).



Configuración de gateway



- Para la interfaz LoRaWAN se debe definir en qué frecuencias va a escuchar/transmitir.
- También es posible cambiar la potencia de transmisión.
- Para la interfaz de backhaul se necesita configuración estándar de redes IP.
- Se debe indicar la URL/IP del servidor de red.
- Hay otras opciones respecto al tratamiento de los paquetes.



Configuración de NS



- Para la interfaz de backhaul se necesita configuración estándar de redes IP (direccionamiento, DNS, etc).
- Se debe indicar la banda de frecuencia (ej. en Lora server: AU_915_928).
- Habilitar ADR y configurar canales disponibles.
- Parámetros de dispositivos según la clase.
- Conexiones de backend con aplicaciones (ej. MQTT, plataformas de IoT, etc.).

Ejemplo de caso de diseño



Use case

Assumptions

- Big City
- **Public LoRaWAN Network Dimensioning**
- Number of devices increase every year
- Total Bandwidth: **1 MHz**



- **LoRa SX1301 Chipset**
- **Bandwidth: 125 KHz**
- **8 channels**
- **Central Frequency: 868 MHz**
- CRC enabled
- Low data rate optimization enabled

Ejemplo de caso de diseño



Service and End Device Modeling

Modeling of:

- End devices (type, technology used, ...)
- Sensors
- Other connected things



Modeling the services

❖ *Fleet Management*: The end device can send a packet in the network every **30 second** to track a vehicle



❖ *Logistic*: an end device can send a packet in the network every **5 min** to report his occupation state



❖ *Water meter*: can send a packet **once a day** to inform the water consumption



Ejemplo de caso de diseño



Traffic Modeling

Several parameters to consider depending on the technology

Packet size

Preamble

Payload

CRC

Change according the services

Number of available channels

More channels → More simultaneous connections

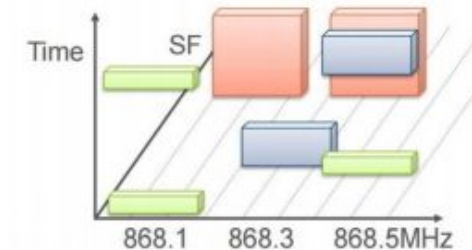

Throughput

Determine the time on Air → Packets inter-arrival time

Gateway Capacity

Gateway capacity (packets/day, maximum throughput, ...)

Ejemplo de caso de diseño

Traffic Modeling

Services	Packet transmission frequency (per hour)
Sensor	1
Metering	0,04
Alarm	1/365/24
Tracking Logistic	2
Vehicle Tracking	6
Traffic Control	60
Agriculture	1
Wearables	2
Home Automation	0,50

Ejemplo de caso de diseño



Gateway Capacity

Lora Gateway **Capacity**: given in terms of **number of packets per day**.

LoRa Packet
(maximum size: 256 bytes)

Preamble	Payload	CRC
Up to 5 bytes	Min: 2 bytes	Up to 2 bytes

Payload Size (byte)	Spreading Factor	Symbol Rate	Programmed Preamble (Symbol)	Preamble Duration (ms)	Coding Rate	Number of payload Symbol	Payload Duration (ms)	Duration of packet (ms)	Single Gateway with 8 channels Capacity (Packets per day)
10	7	0,98	6	10	2	32	32	43	1 997 041
10	8	0,49	6	20	1	23	47	68	1 268 797
5	9	0,24	6	41	2	14	57	99	869 845
15	10	0,12	6	83	4	40	327	411	209 888
15	11	0,06	6	167	1	23	376	544	158 600
10	7	0,98	6	10	4	40	40	51	1 679 104
15	8	0,49	6	20	1	33	67	88	975 434
12	9	0,24	6	41	3	29	118	160	537 420
12	10	0,12	6	83	1	23	188	272	317 199

Ejemplo de caso de diseño



IoT Applications with Different Characteristics

Example Applications	Data volume	Quality of Service	Amount of signaling	Time sensitivity	Mobility	Server initiated Communication	Packet switched only
Smart energy meters	low	low	intermediate	low	no	yes	yes
Red charging	low	low	low	low	yes	no	yes
eCall	very low	very high	very low	very high	yes	no	no
Remote maintenance	low	low	high	high	no	yes	yes
Fleet management	low	low	very high	intermediate	yes	yes	no
Photo frames	intermediate	low	high	low	no	yes	yes
Assets tracking	low	low	very high	high	yes	yes	no
Mobile payments	intermediate	low	high	very high	yes	no	yes
Media synchronisation	high	low	high	intermediate	yes	yes	yes
Surveillance cameras	very high	very high	low	very high	no	yes	yes
Health monitoring	high	high	high	very high	yes	yes	yes

very low
 low
 intermediate
 high
 very high

Ejemplo de caso de diseño

First Year

Gateway Capacity: 1 500 000 packets per day

Services	Packet transmission frequency (at BH)	End devices Number	Number of packets per day for one device	Burstiness Margin	Security Margin	Number of packets
Sensor	1	200	24	20%	10%	152 064
Metering	0,04	100,00	1	20%	10%	132
Alarm	0,00	100,00	1	20%	10%	132
Tracking Logistic	2	100	48	20%	10%	304 128
Vehicle Tracking	6	70	144	20%	10%	1 916 007
Traffic Control	10	150	240	20%	10%	11 404 800
Agriculture	1	200,00	24	20%	10%	152 064
Wearables	0,5	1000,00	12	20%	10%	190 080
Home Automation	0,5	300	12	20%	10%	57 024
Total Packets per day						14 176 431

Number of Gateways: 10

Ejemplo de caso de diseño

Second Year

Gateway Capacity: 1 500 000 packets per day

Services	Packet transmission frequency (at BH)	End device Number	Number of packets per day for one device	Burstiness Margin	Security Margin	Number of packet
Sensor	1	400	24	20%	10%	304 128
Metering	0,04	200	1	20%	10%	264
Alarm	0,00	200	1	20%	10%	264
Tracking Logistic	2	200	48	20%	10%	608 256
Vehicle Tracking	6	140	144	20%	10%	3 832 013
Traffic Control	10	300	240	20%	10%	22 809 600
Agriculture	1	400	24	20%	10%	304 128
Wearables	0,5	2000	12	20%	10%	380 160
Home Automation	0,5	600	12	20%	10%	114 048
Total Packets per day						28 352 861

Number of Gateways: 19

Ejemplo de caso de diseño

Third Year

Services	Packet transmission frequency (at BH)	End device Number	Number of packets per day for one device	Burstiness Margin	Security Margin	Number of packets
Sensor	1	800	24	20%	10%	608 256
Metering	0,04	400	1	20%	10%	528
Alarm	0,00	400	1	20%	10%	528
Tracking Logistic	2	400	48	20%	10%	1 216 512
Vehicle Tracking	6	300	144	20%	10%	8 211 456
Traffic Control	10	600	240	20%	10%	45 619 200
Agriculture	1	800	24	20%	10%	608 256
Wearables	0,5	3000	12	20%	10%	570 240
Home Automation	0,5	1200	12	20%	10%	228 096
Total Packets per day						57 063 072

Number of Gateways: **39**



Referencias



- Documentación del estándar:
 - [LoRaWAN specification v1.1](#)
 - [LoRaWAN regional parameters v1.1](#)
 - [LoRaWAN 1.0.4 Specification Package](#)
 - [RP2-1.0.3 LoRaWAN Regional Parameters](#)
- Presentación de curso de ITU sobre IoT: ["IoT Network Planning"](#), Diciembre 2016.
- Presentación Cisco Live 2019 sobre LoRaWAN: [LoRaWAN for IOT Enterprises services](#).





Referencias



- Tesis de maestría, Instituto Superior de Ingeniería de Lisboa: ["IoT Network – Design and Implementation"](#), Diciembre 2018.
- Tesis de maestría, FING-UDELAR: ["Plataforma de Pruebas de Conformidad LoRaWAN"](#), Pablo Modernell, Octubre 2020.
- Presentación en WLPC 2022: ["LoRaWAN Overview"](#), Troy Martin, Febrero 2022.
- Artículo en TTN: [What's new in LoRaWAN 1.0.4?](#)
- Curso [AWS IoT Core for LoRaWAN workshop](#).





FIN

Muchas Gracias.
¿Preguntas?

gcapde@fing.edu.uy

