

Compresión de la señal digital y su distribución: JPEG

[Rafael Sotelo](#)

JPEG

- Joint Photographic Experts Group
- Establecido en 1992. Basado en la DCT, transformada de coseno discreta.
- ISO/IEC 10918, *Information Technology – Digital compression and coding of continuous-tone still images.*
- *No existía la World Wide Web → ¡se proyectaba utilizarlo en máquinas de fax a color!*

Reducción de la tasa de bits en video

- Redundancia estadística de datos.
 - Redundancia espacial.
 - Redundancia temporal.
- Redundancia psicovisual.
 - El sistema visual humano no percibe de la misma forma todos los valores posibles de las muestras.
- Codificación
 - Un evento menos probable provee más información que uno más probable.

Características del Sistema Visual Humano

- Sensibilidad de frecuencia espacial: altas frecuencias son menos visibles.
- Errores en regiones texturadas son difíciles de ver. Somos muy sensibles a errores en regiones uniformes.
- Errores cerca de los bordes son difíciles de ver.
- El umbral visual aumenta con la iluminación del fondo.
- Errores en porciones claras son más difíciles de ver.

Técnicas de reducción de la tasa de bits

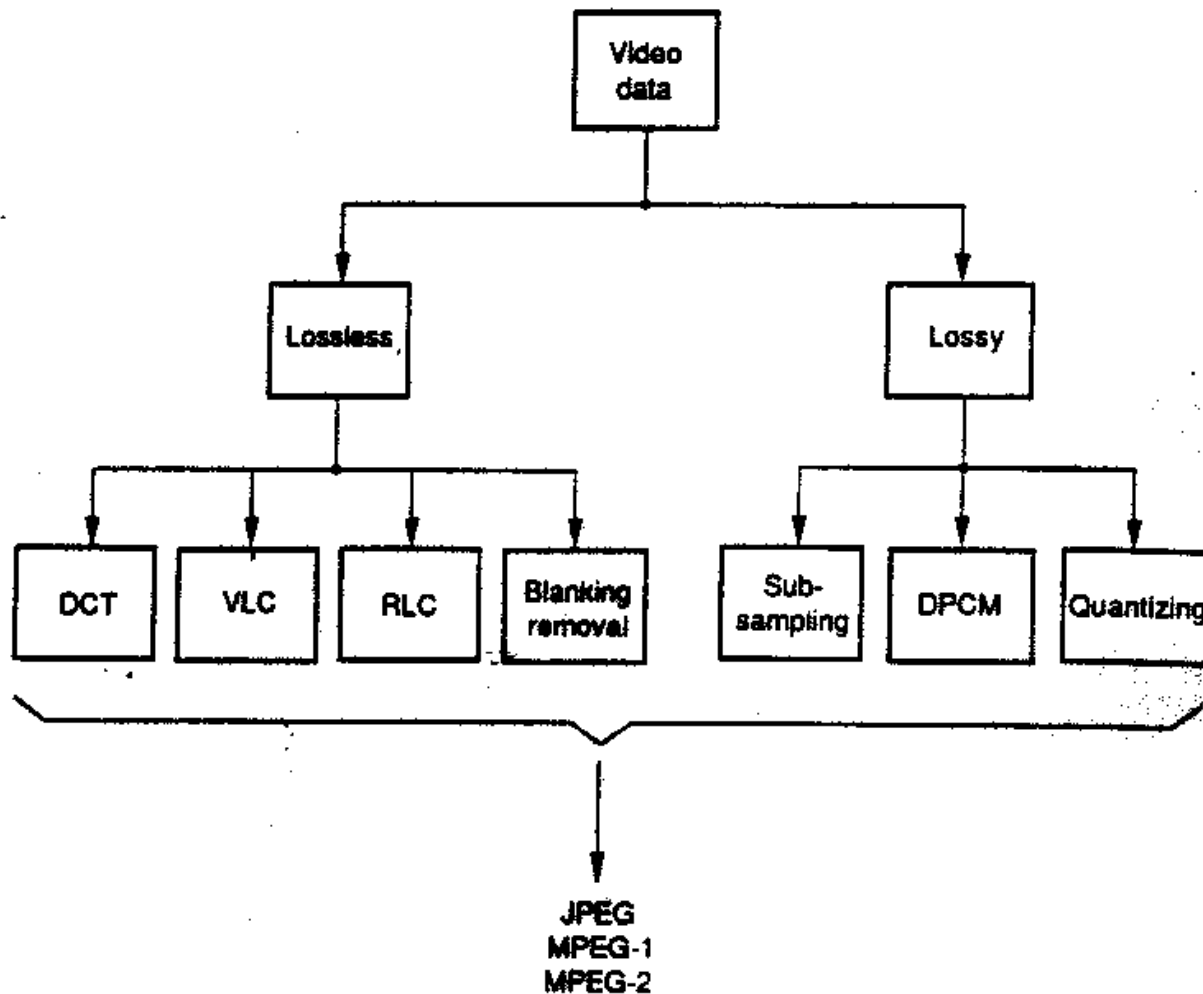
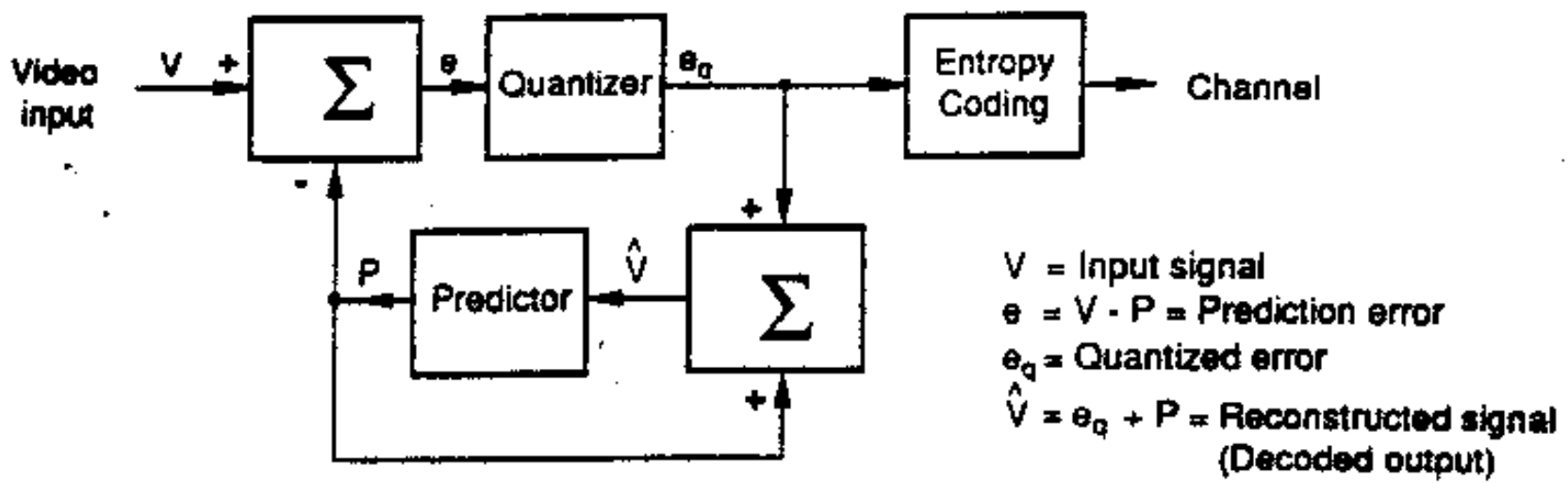


Figure 8.5 Summary of lossless and lossy data reduction techniques which are combined to generate JPEG and MPEG data signals.

a) DPCM encoder



b) DPCM decoder

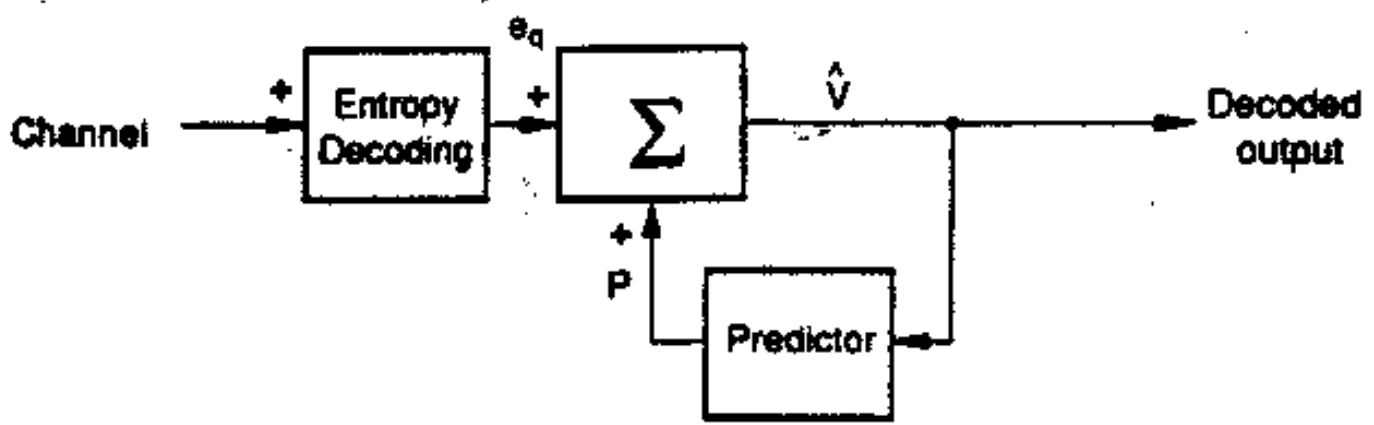
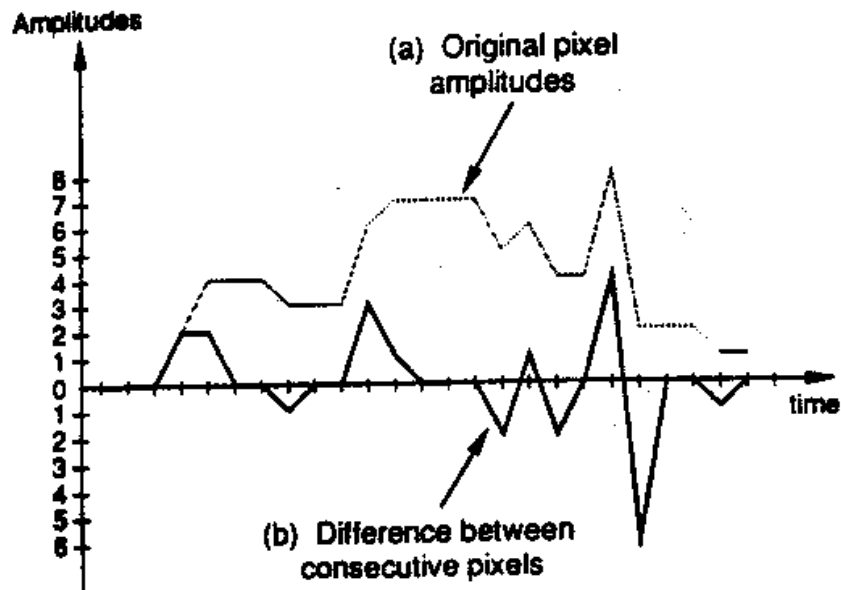
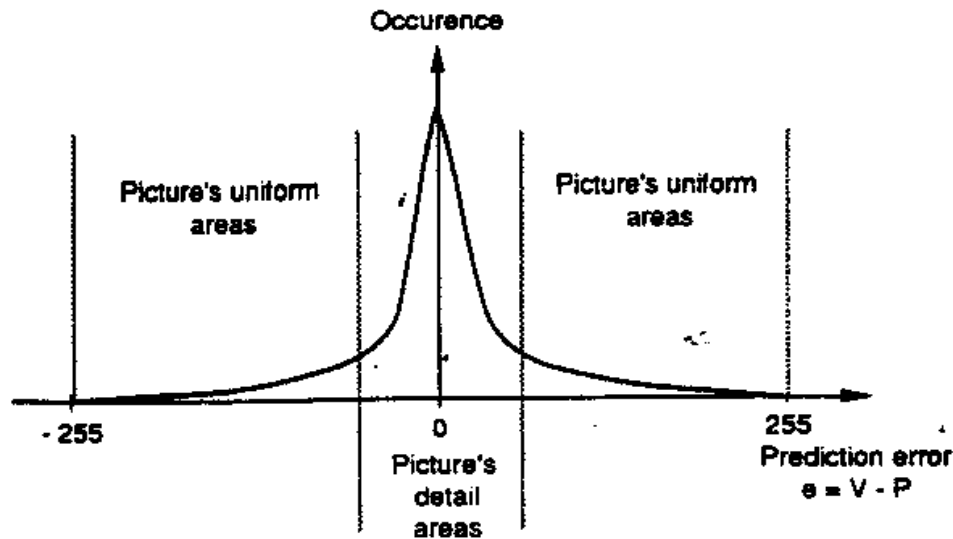


Figure 8.6 DPCM encoder/decoder.



Amplitude values	Probability of occurrence	
	(a)	(b)
-8		1
-5		0
-4		0
-3		0
-2		2
-1		2
0	2	12
1	2	1
2	4	2
3	3	1
4	5	1
5	1	0
6	2	0
7	4	0
8	1	0

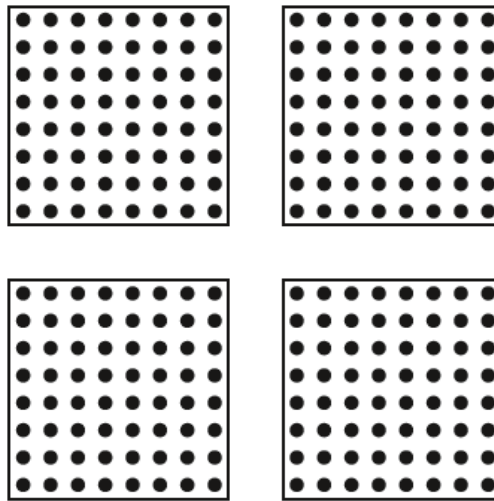


(c) Prediction error histogram based on a long term average of TV pictures.

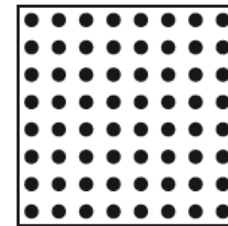
Figure 8.7 DPCM encoding and entropy reduction.

Figure 45.1 A JPEG 4:2:0 minimum coded unit (MCU) comprises six 8×8 blocks: four luma blocks, a block of C_B , and a block of C_R . The six constituent blocks result from nonlinear $R'G'B'$ data being matrixed to $Y'C_BC_R$, then subsampled according to the 4:2:0 scheme; chroma subsampling is effectively the first stage of compression. The blocks are processed independently.

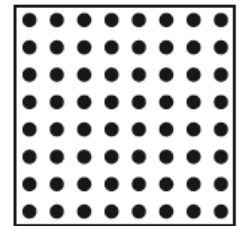
Four 8×8 Luma (Y') blocks



$8 \times 8 C_B$ block



$8 \times 8 C_R$ block

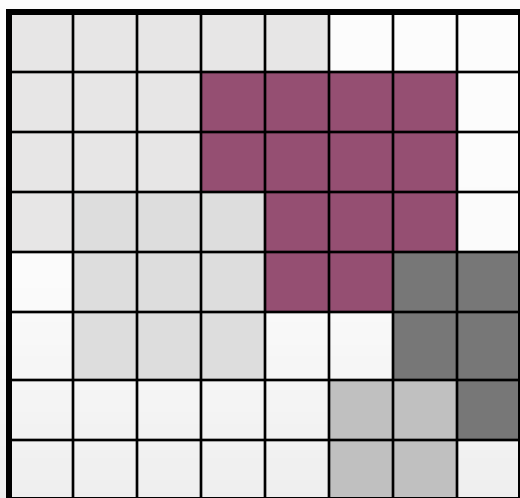


Transformada de coseno discreta - DCT

$$F_{u,v} = \frac{1}{4} C(u) C(v) \sum_{i=0}^7 \sum_{j=0}^7 f_{i,j} \cos \left[\frac{(2i+1)u\pi}{16} \right] \cos \left[\frac{(2j+1)v\pi}{16} \right];$$

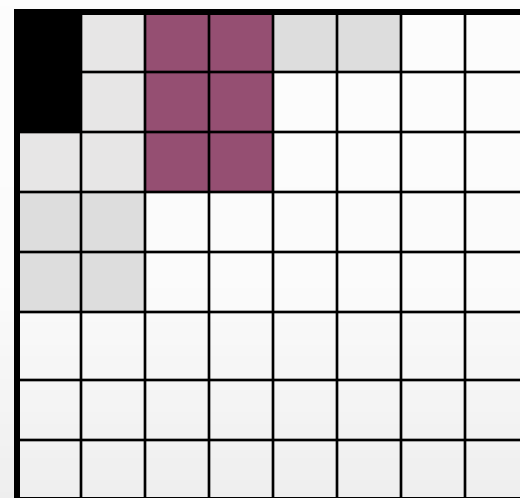
$$C(w) = \begin{cases} \frac{1}{\sqrt{2}}; & w = 0 \\ 1; & w = 1, 2, \dots, 7 \end{cases}$$

Transformada de Coseno Discreta (DCT)



$f(x,y) = 64$ elementos
de imagen (8x8 pixels)

DCT



$F(u,v) = 64$ componentes
de frecuencias especiales

Transformada de coseno discreta - DCT

$$F(u,v) = \frac{C(u)C(v)}{4} \sum_{j=0}^7 \sum_{k=0}^7 f(j,k) \cos\left(\frac{(2j+1)u\pi}{16}\right) \cos\left(\frac{(2k+1)v\pi}{16}\right) \quad (\text{Eq. 8.1})$$

where $f(j,k)$ = the original samples in the 8×8 luminance pixel block.

$F(u,v)$ = coefficients of the 8×8 DCT block.

u = the normalized horizontal frequency ($0 < u < 7$).

v = the normalized vertical frequency ($0 < v < 7$).

$$C(u), C(v) = 1/\sqrt{2} \quad \text{if } u, v = 0$$

$$C(u), C(v) = 1 \quad \text{if } u, v = 1, 2, \dots, 7$$

For the first coefficient, the normalized frequencies u and v are equal to 0. Then, this coefficient is called the DC coefficient.

$$F(0,0) = \frac{1}{8} \sum_{j=0}^7 \sum_{k=0}^7 f(j,k) \quad (\text{Eq. 8.2})$$

Transformada de Coseno Discreta (DCT)

- Cada coeficiente $F(u,v)$ expresa la semejanza (correlación) entre el bloque de 8x8 pixels y una determinada función primitiva correspondiente:

$$P_{u,v}(x, y) = \cos\left(\frac{(2x+1)u\pi}{16}\right) \times \cos\left(\frac{(2x+1)v\pi}{16}\right)$$

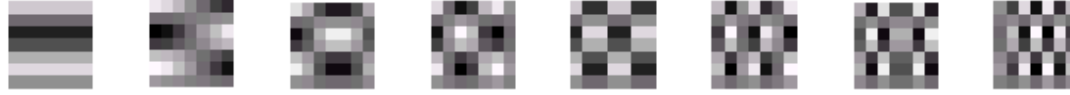
Primitivas de la Transformada de Coseno Discreta (DCT)

$P_{0,0}$



$P_{0,7}$

$P_{1,0}$

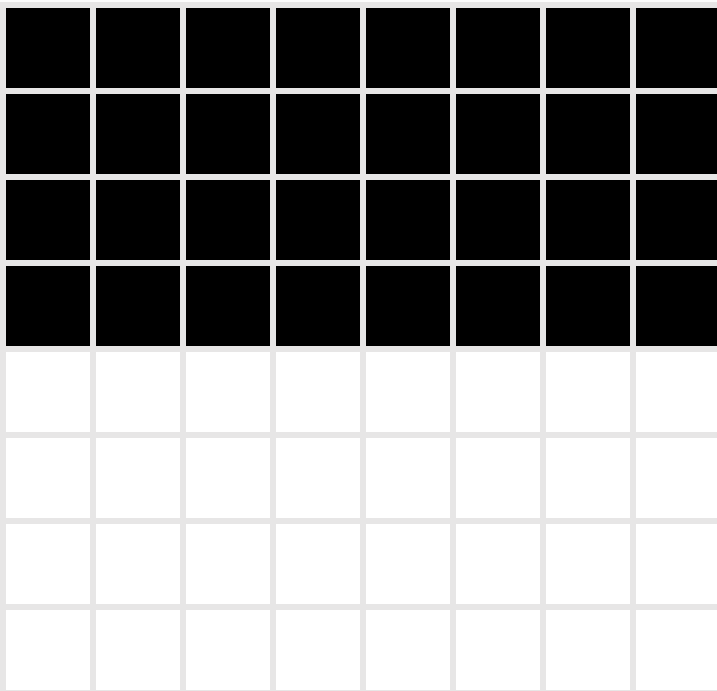


$P_{7,0}$



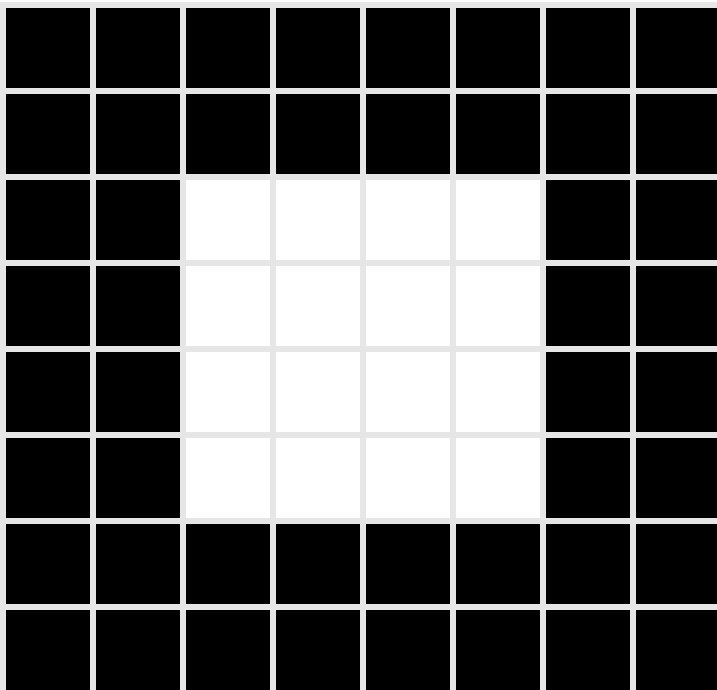
$P_{7,7}$

Ejemplo de Transformada DCT



-4	0	0	0	0	0	0	0
-924	0	0	0	0	0	0	0
0	0	0	0	0	0	0	0
325	0	0	0	0	0	0	0
0	0	0	0	0	0	0	0
-217	0	0	0	0	0	0	0
0	0	0	0	0	0	0	0
184	0	0	0	0	0	0	0

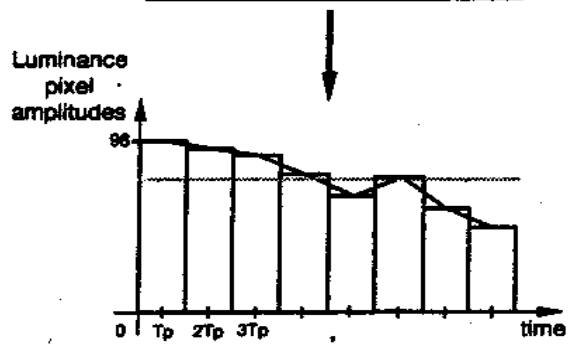
Ejemplo de Transformada DCT



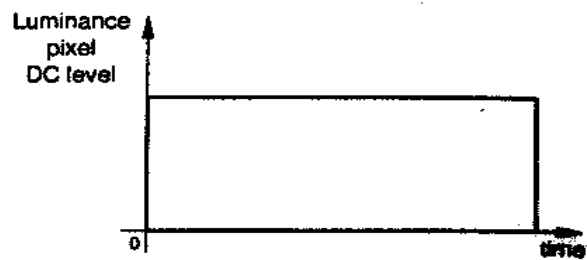
-514	0	-471	0	0	0	195	0
0	0	0	0	0	0	0	0
-471	0	435	0	0	0	-180	0
0	0	0	0	0	0	0	0
0	0	0	0	0	0	0	0
0	0	0	0	0	0	0	0
195	0	0	0	0	0	75	0
0	0	0	0	0	0	0	0

8 consecutive luminance pixels taken from one line

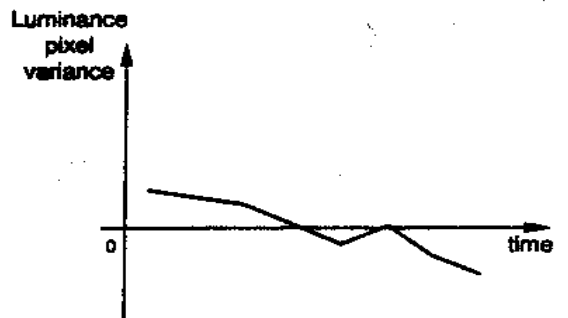
98	92	95	80	75	82	68	50
----	----	----	----	----	----	----	----



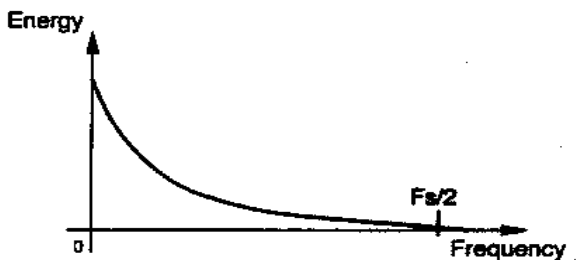
a) Luminance amplitude for the 8 consecutive pixels



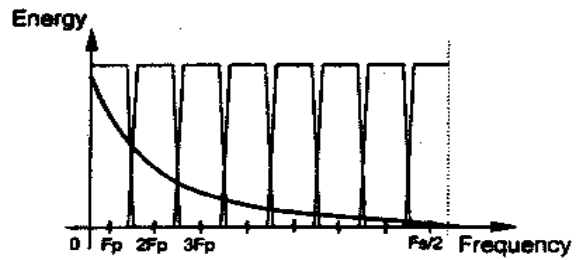
b) Average DC level of the 1x8 block



c) Variance from average level



d) 1x8 block luminance pixel spectrum



e) Luminance spectrum band separation



591	106	-18	28	-34	14	18	3
-----	-----	-----	----	-----	----	----	---

DC coefficient AC coefficients

f) 1x8 DCT coefficient values

Figure 8.8 Summary of 1-Dimensional DCT coding (Courtesy of Sony Corporation).

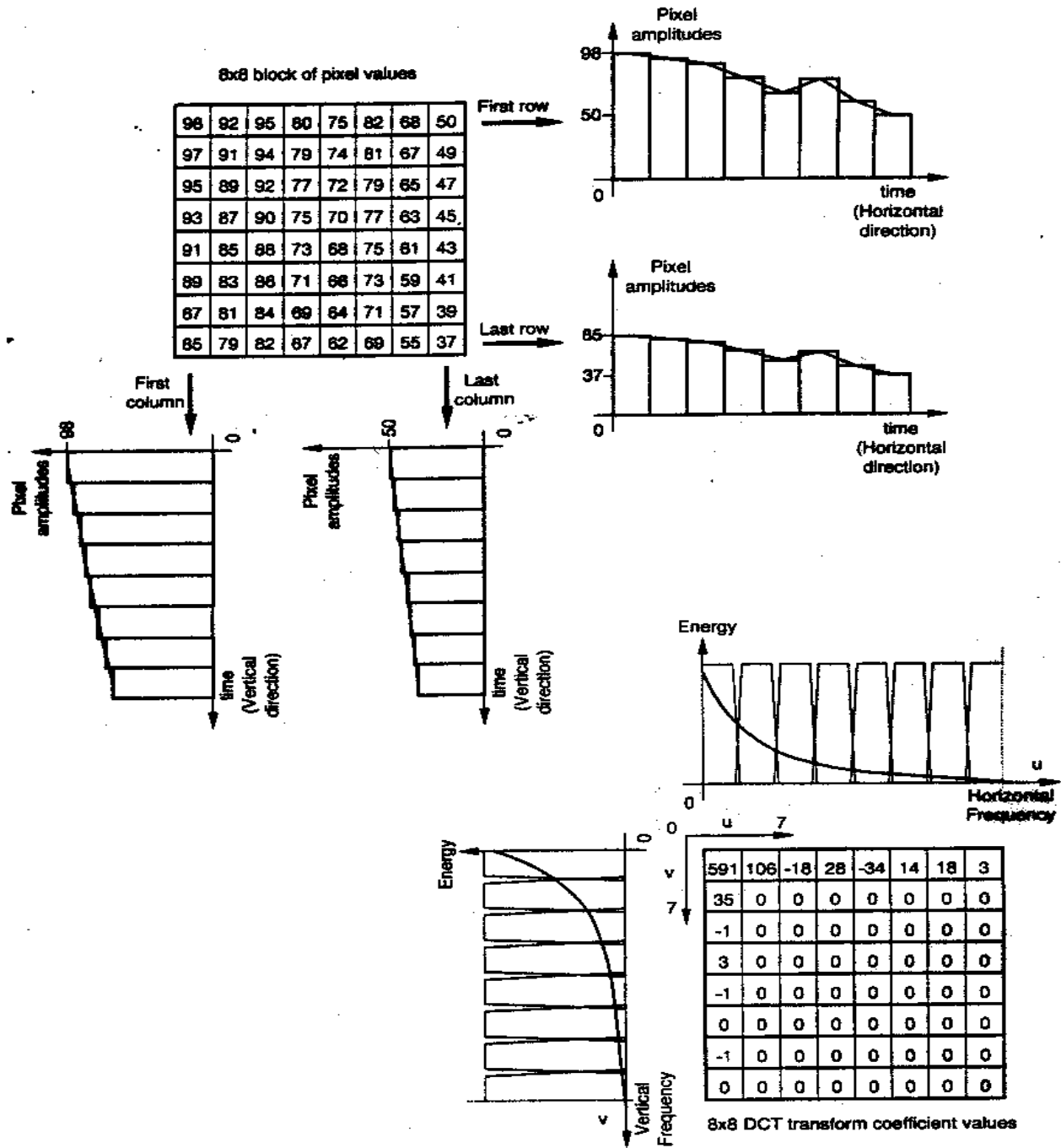


Figure 8.9 Summary of 2-Dimensional DCT block coding (Courtesy of Sony Corporation).

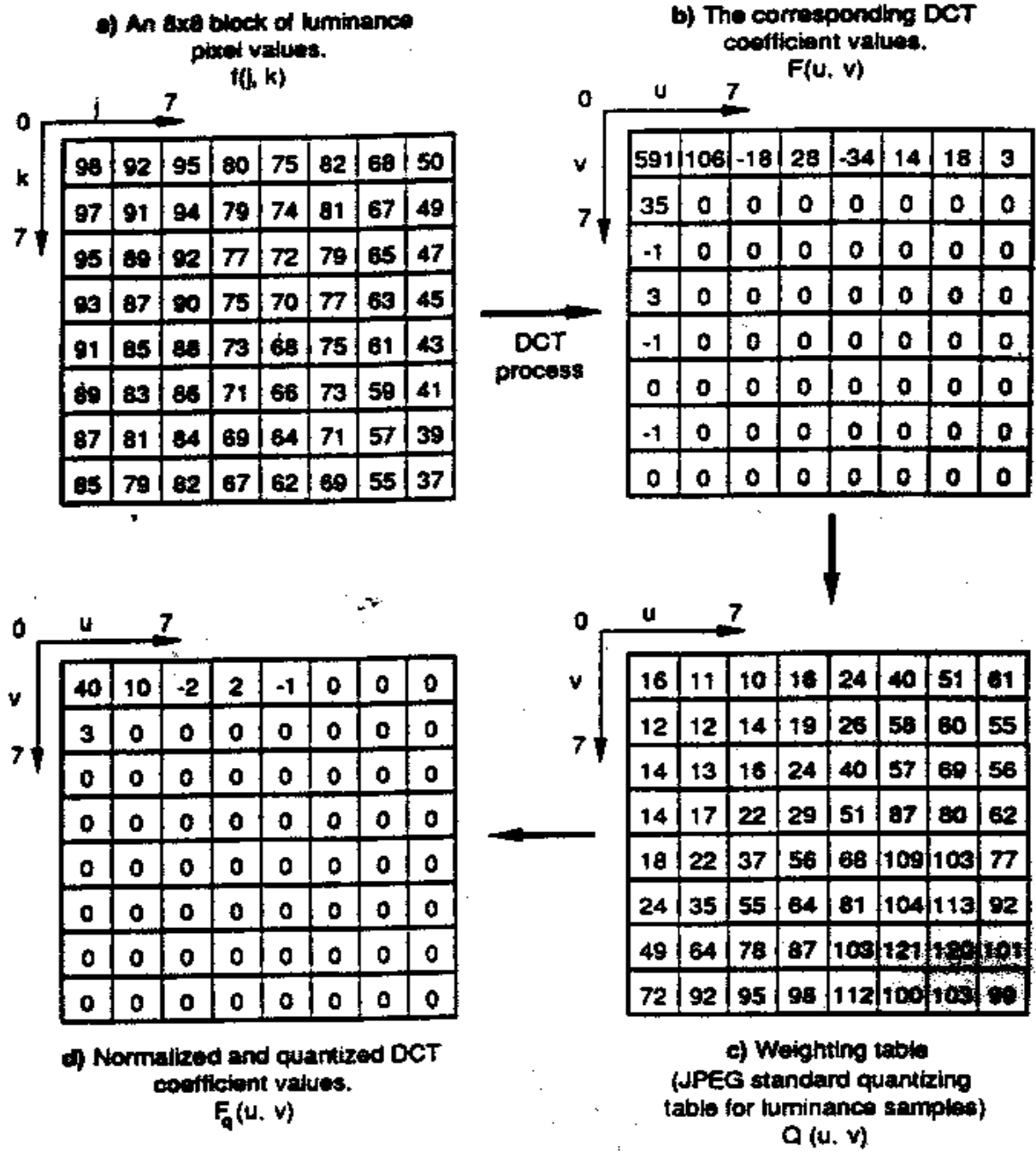


Figure 8.10 8x8 DCT block formatting, example #1.

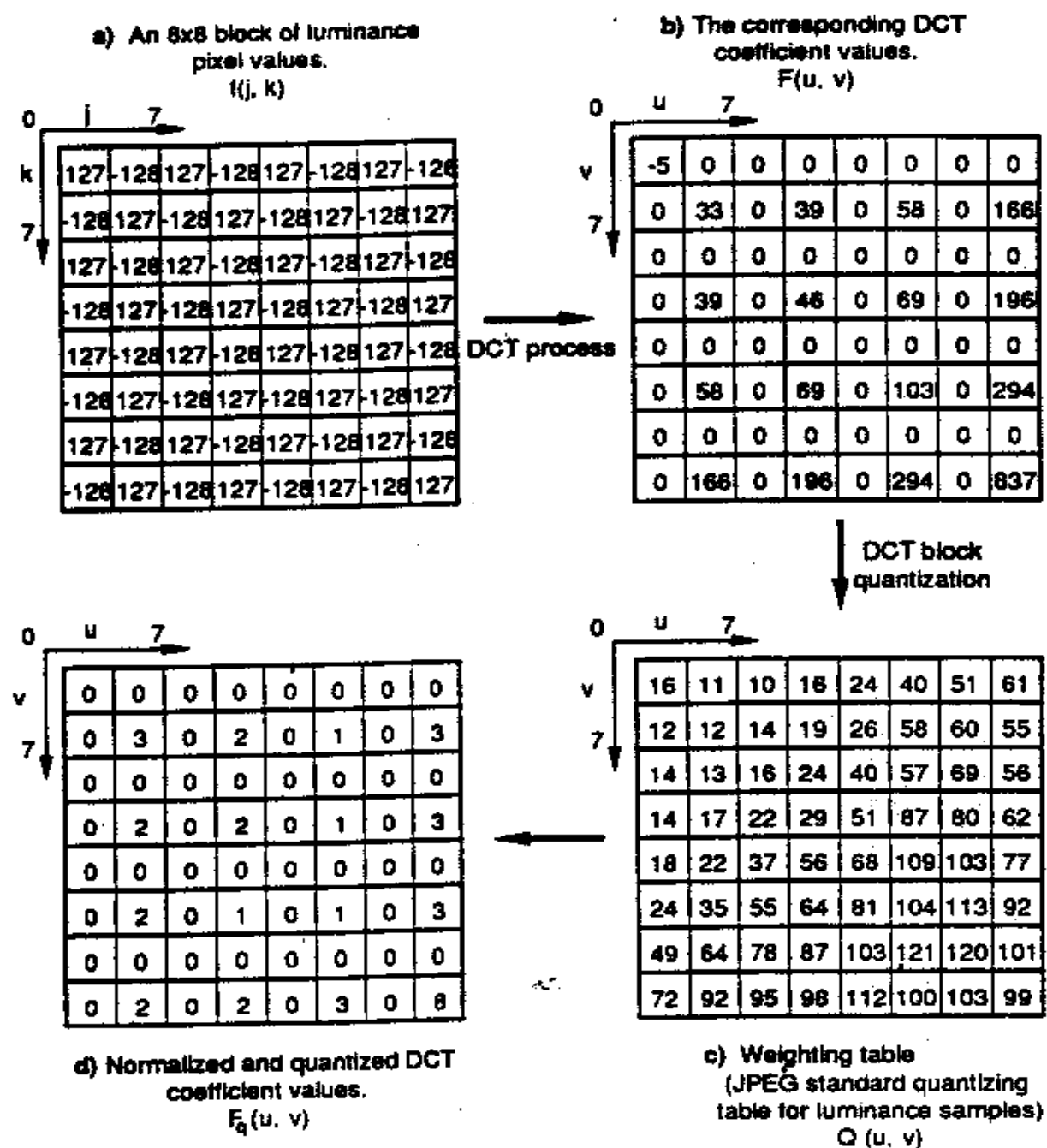
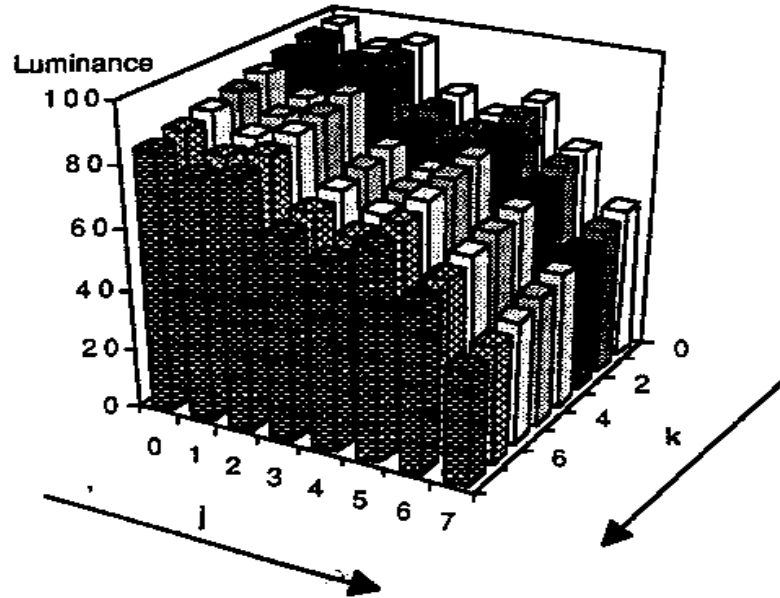
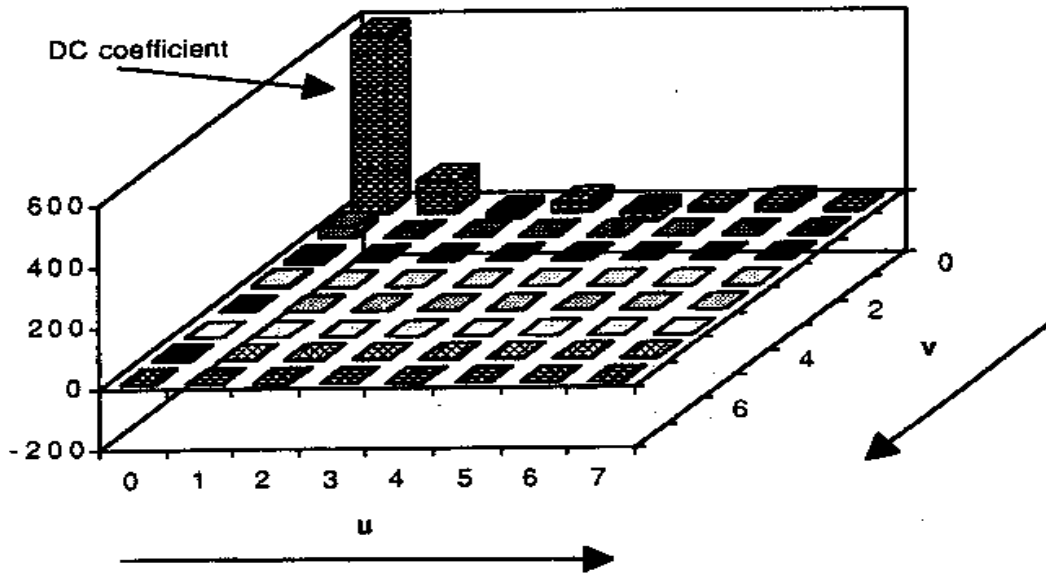


Figure 8.11 8x8 DCT block formatting, example #2: checkerboard picture.

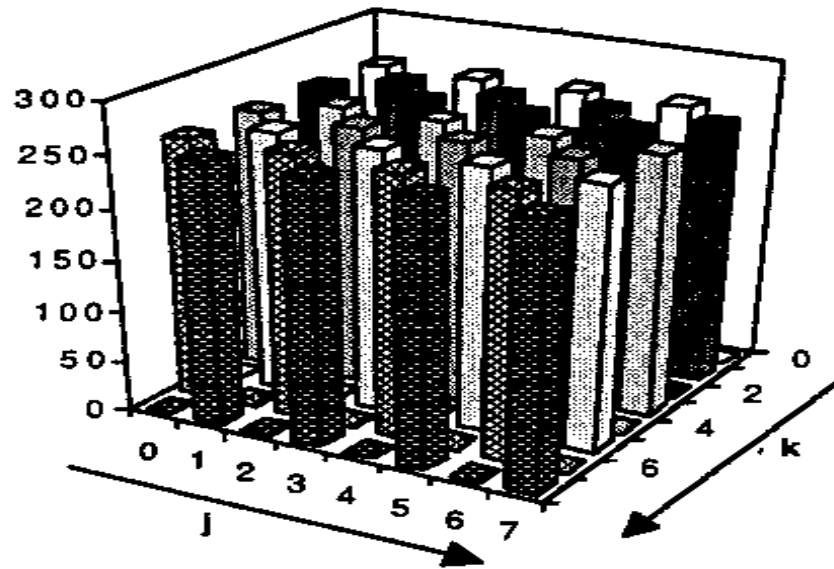


a) 3-D display of original luminance values (example #1)

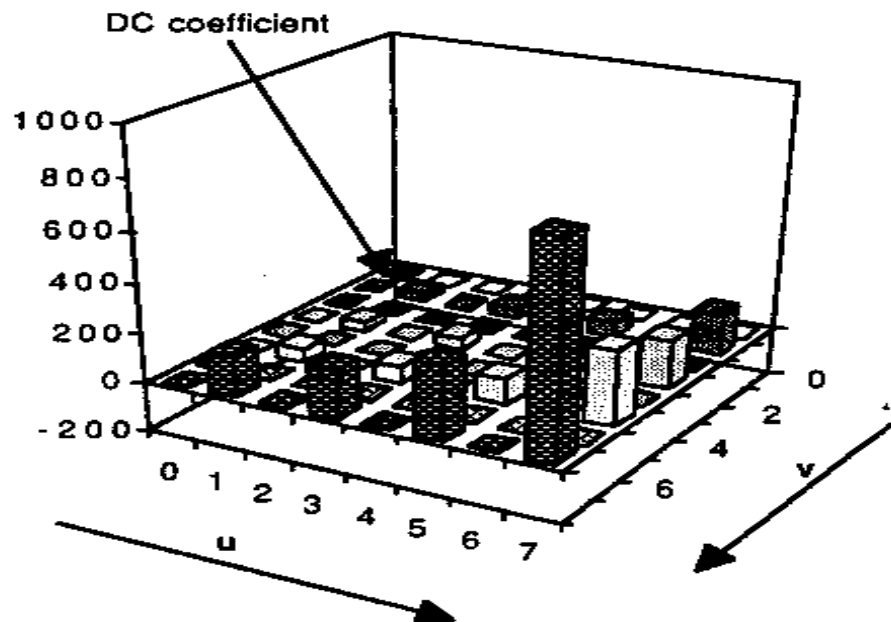


b) 3-D display of DCT coefficients (example #1)

Figure 8.12 3-D display of original luminance values and DCT coefficients (example #1).



a) 3-D display of original luminance values (example #2)



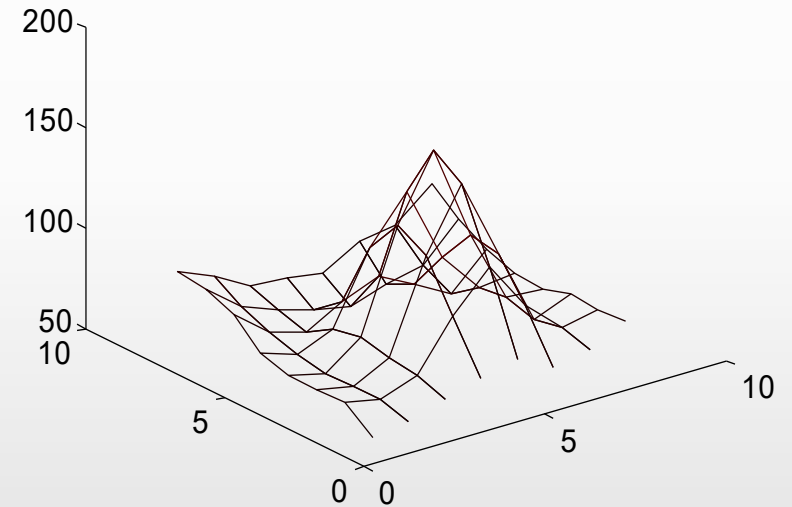
b) 3-D display of DCT coefficients (example #2)

Figure 8.13 3-D display of original luminance values and DCT coefficients (example #2).

Ejemplo de Codificación DCT

52	55	61	66	70	61	64	73
63	59	66	90	109	85	69	72
62	59	68	113	144	104	66	73
63	58	71	122	154	106	70	69
67	61	68	104	126	88	68	70
79	65	60	70	77	68	58	75
85	71	64	59	55	61	65	83
87	79	69	68	65	76	78	94

Bloque 8 x 8



Coeficientes DCT

-415	-29	-62	25	55	-20	-1	3
7	-21	-62	9	11	-7	-6	6
-46	8	77	-25	-30	10	7	-5
-50	13	35	-15	-9	6	0	3
11	-8	-13	-2	-1	1	-4	1
-10	1	3	-3	-1	0	2	-1
-4	-1	2	-1	2	-3	1	-2
-1	-1	-1	-2	-1	-1	0	-1

Coeficientes DCT Cuantizados

-26	-3	-6	2	2	0	0	0
1	-2	-4	0	0	0	0	0
-3	1	5	-1	-1	0	0	0
-4	1	2	-1	0	0	0	0
1	0	0	0	0	0	0	0
0	0	0	0	0	0	0	0
0	0	0	0	0	0	0	0
0	0	0	0	0	0	0	0

Imagen Reconstruida

58	64	67	64	59	62	70	78
56	55	67	89	98	88	74	69
60	50	70	119	141	116	80	64
69	51	71	128	149	115	77	68
74	53	64	105	115	84	65	72
76	57	56	74	75	57	57	74
83	69	59	60	61	61	67	78
93	81	67	62	69	80	84	84

-6	-9	-6	2	11	-1	-6	-5
7	4	-1	1	11	-3	-5	3
2	9	-2	-6	-3	-12	-14	9
-6	7	0	-4	-5	-9	-7	1
-7	8	4	-1	11	4	3	-2
3	8	4	-4	2	11	1	1
2	2	5	-1	-6	0	-2	5
-6	-2	2	6	-4	-4	-6	10

Error de Reconstrucción

Reconstrucción de Imagen JPEG

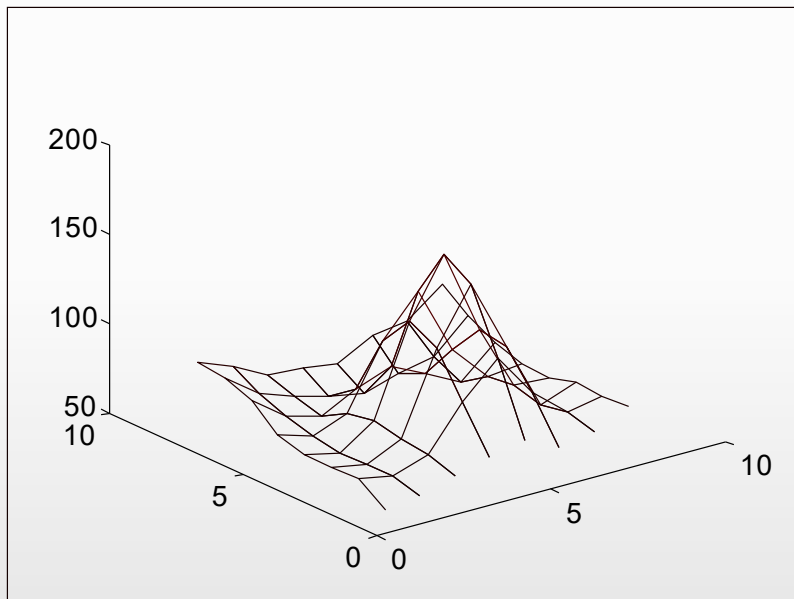


Imagen Original

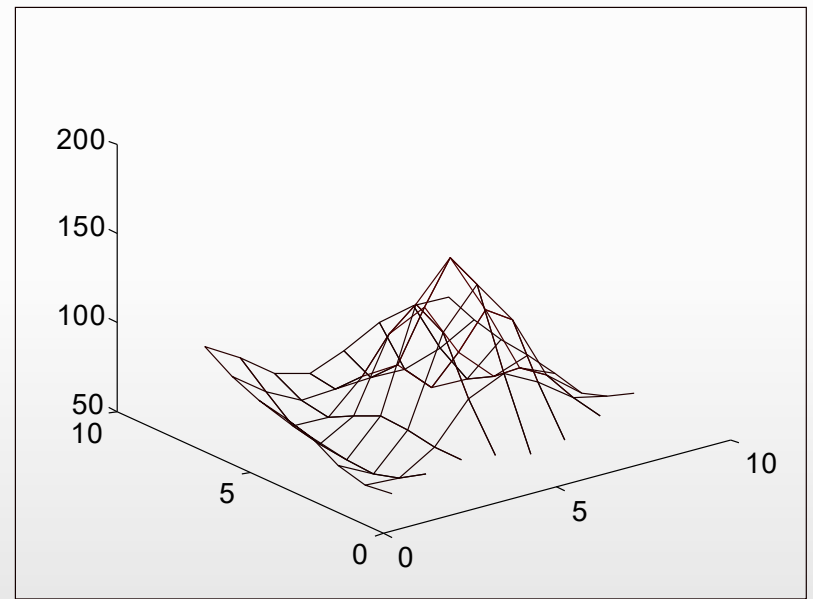


Imagen Reconstruida

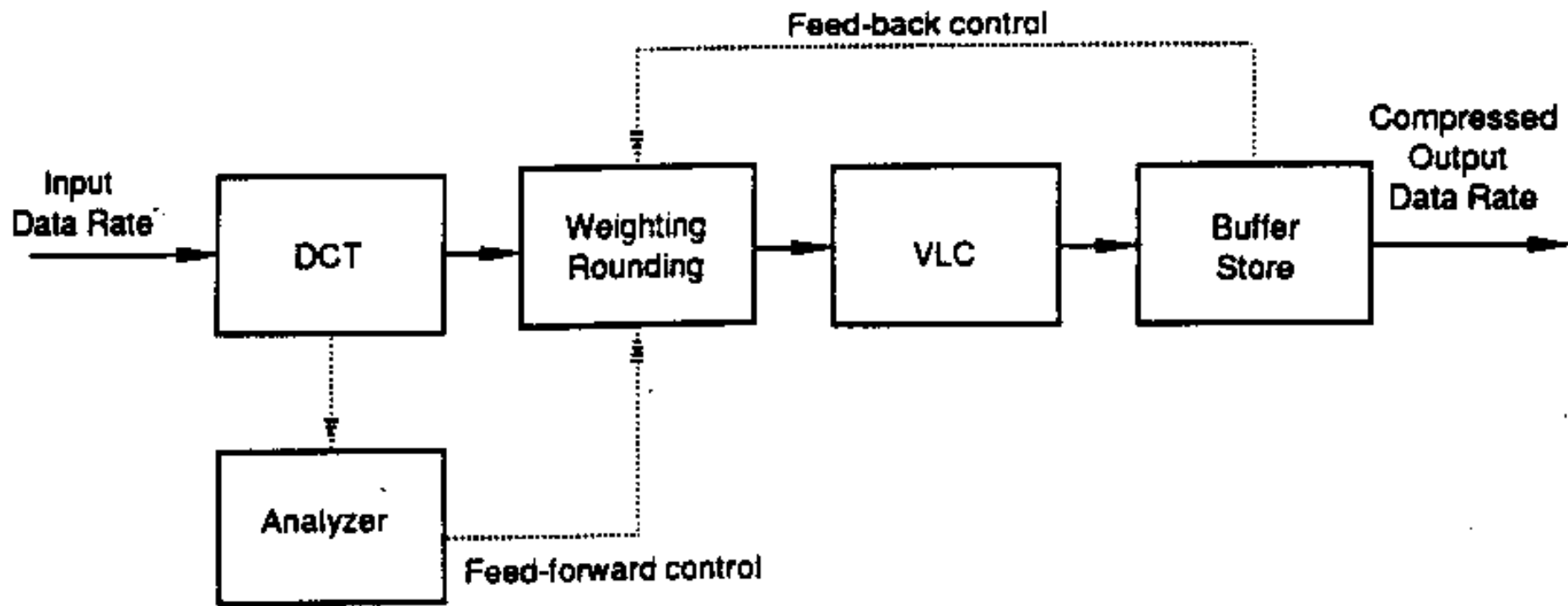


Figure 8.14 Simplified video data reduction process using a DCT scheme.

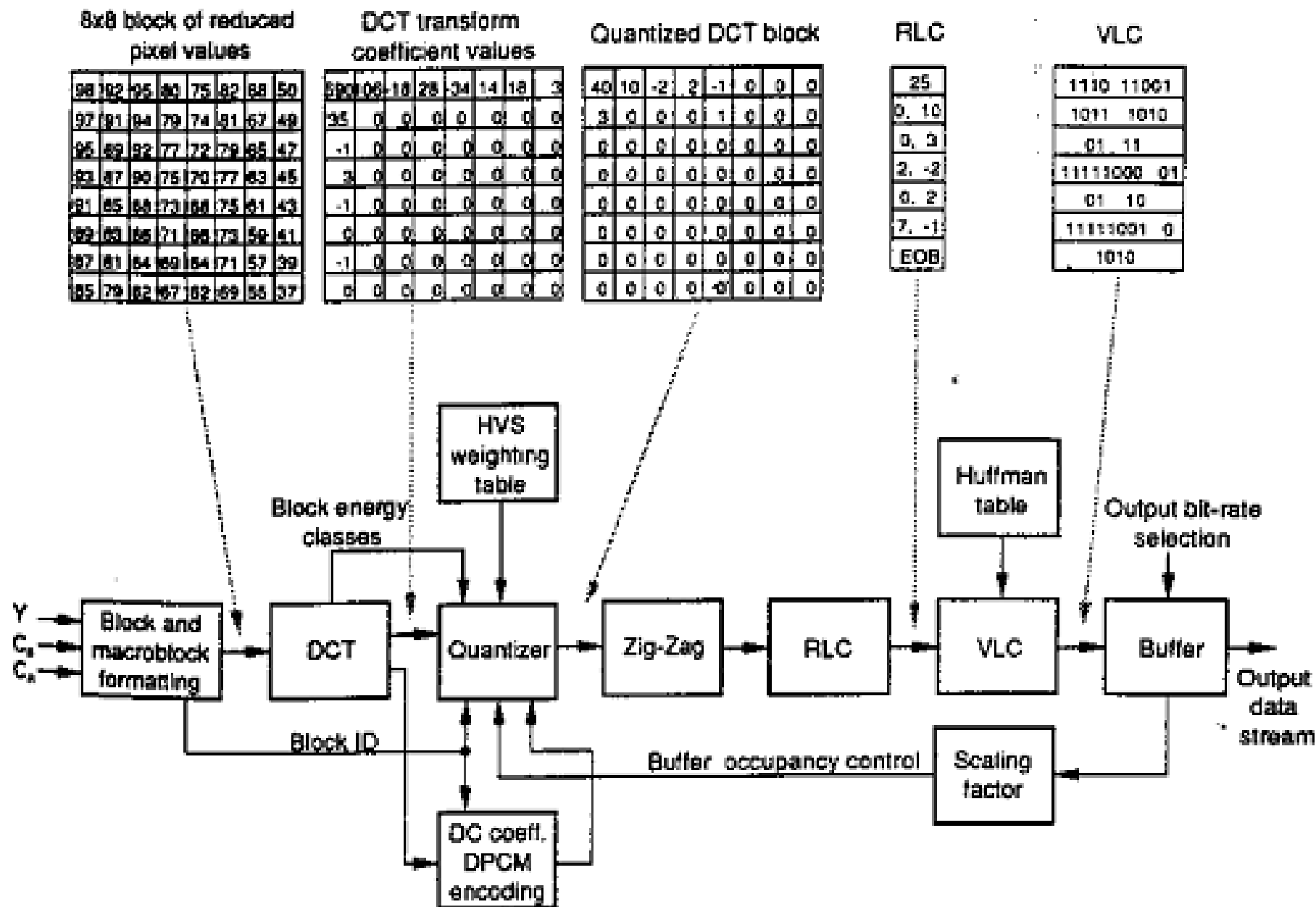


Figure 8.16 Basic picture data reduction process made with a DCT coding scheme.

- Matriz de cuantificación

0	1 → 7							
k	16	11	10	16	24	40	51	61
	12	12	14	19	26	58	60	55
	14	13	16	24	40	57	69	56
	14	17	22	29	51	87	80	62
	18	22	37	56	68	109	103	77
	24	35	55	64	81	104	113	92
	49	64	78	87	103	121	120	101
7	72	92	95	98	112	100	103	99

**Weighting table
(JPEG standard quantizing
table for luminance samples)**

0	1 → 7							
k	17	18	24	47	99	99	99	99
	18	21	26	66	99	99	99	99
	24	26	56	99	99	99	99	99
	47	66	99	99	99	99	99	99
	99	99	99	99	99	99	99	99
	99	99	99	99	99	99	99	99
	99	99	99	99	99	99	99	99
7	99	99	99	99	99	99	99	99

**Weighting table
(JPEG standard quantizing
table for chrominance samples)**

Figure 8.17 JPEG standard quantization tables for luminance and chrominance signals.

- Zigzag scanning

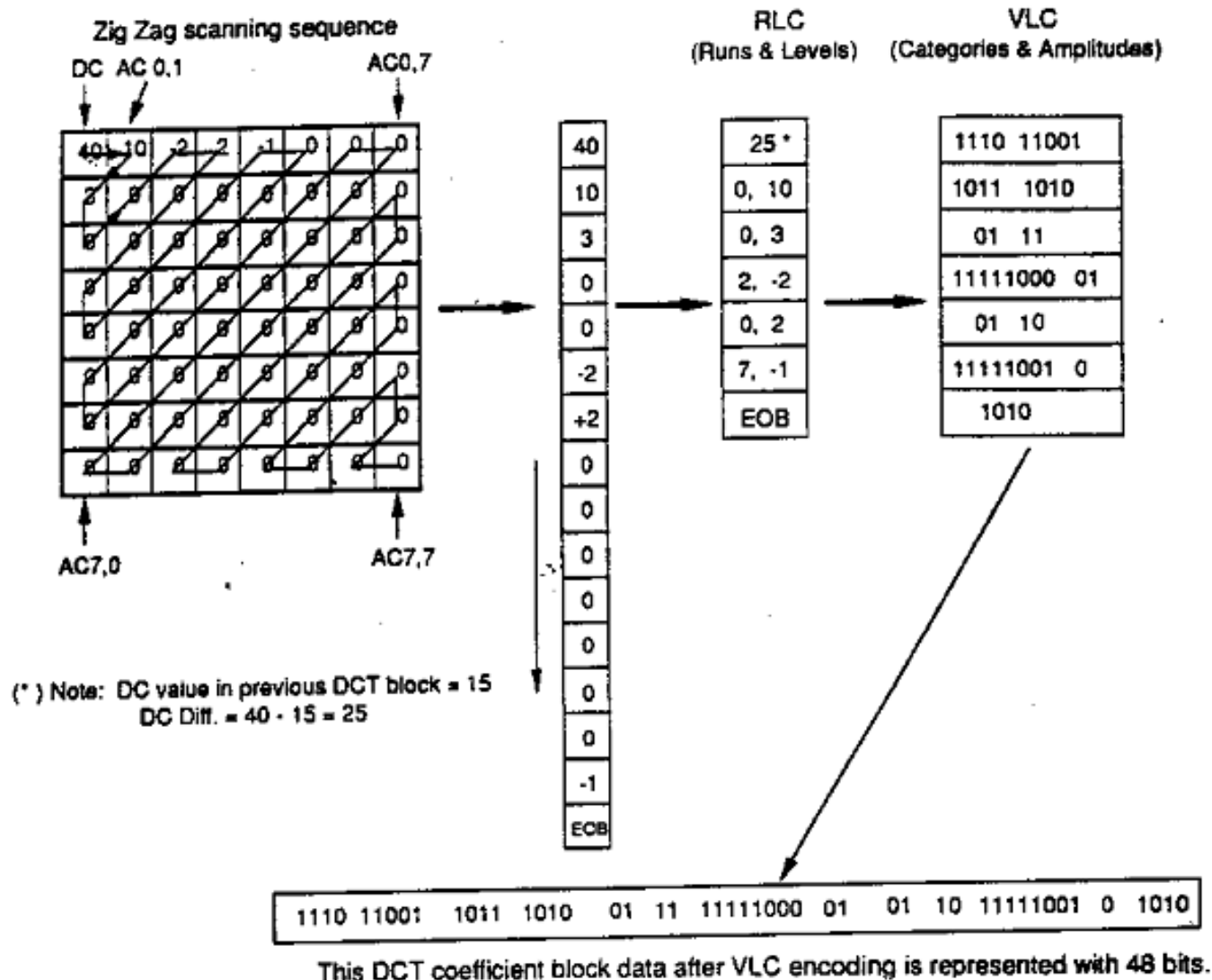


Figure 8.18 Zigzag scanning and Huffman encoding.

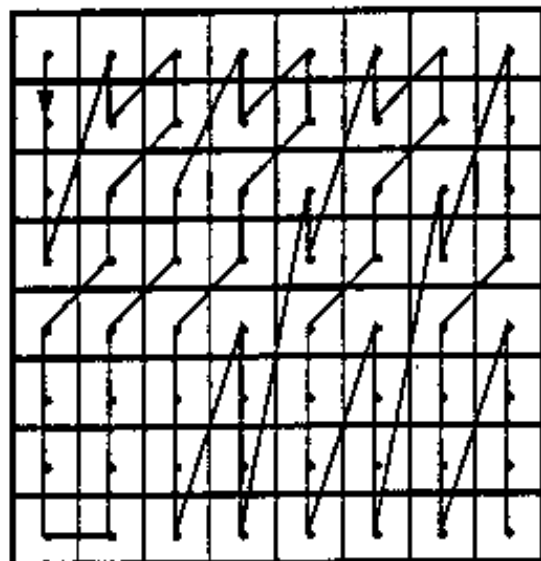


Figure 8.19 Other possible DCT coefficient block scanning process (MPEG-2 Standard).

TABLE 8.1 AC Coefficient Ranges and Categories

Category	Coefficient range	
NA	0	
1	-1,	1
2	-3, -2,	2, 3
3	-7, -6, -5, -4,	4, 5, 6, 7
4	-15,.....,-8,	8,.....,15
5	-31,.....,-16,	16,.....,31
6	-63,.....,-32,	32,.....,63
7	-127,.....,-64,	64,.....,127
8	-255,.....,-128,	128,.....,255
9	-511,.....,-256,	256,.....,511
10	-1023,.....,-512,	512,.....,1023
11	-2047,.....,-1024,	1024,.....,2047
⋮	⋮	

- Codificación de largo variable (VLC)

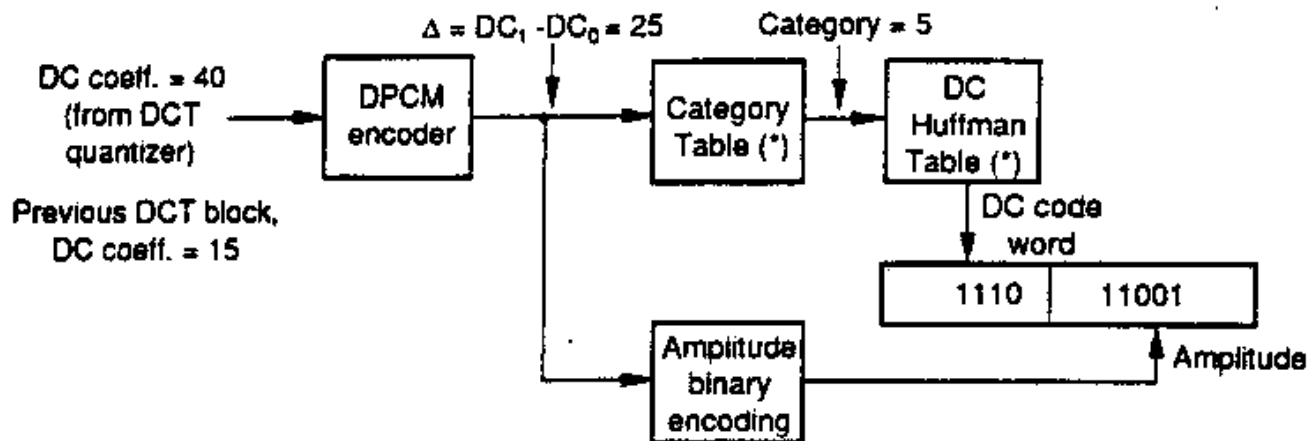
TABLE 8.2 Example of an AC Coefficient Huffman Code Table (JPEG Default Table)

Zero run	Category	Code length	Code word
0	1	2	00
0	2	2	01
0	3	3	100
0	4	4	1011
0	5	5	11010
0	6	6	111000
0	7	7	1111000
:	:	:	:
1	1	4	1100
1	2	6	111001
1	3	7	1111001
1	4	9	111110110
:	:	:	:
2	1	5	11011
2	2	8	11111000
:	:	:	:
3	1	6	111010
3	2	9	111110111
:	:	:	:
4	1	6	111011
5	1	7	1111010
6	1	7	1111011
7	1	8	11111001
8	1	8	11111010
9	1	9	111111000
10	1	9	111111001
11	1	9	111111010
:	:	:	:
End of Block (EOB)		4	1010

TABLE 8.3 Variable Length Codes for DC Coefficients

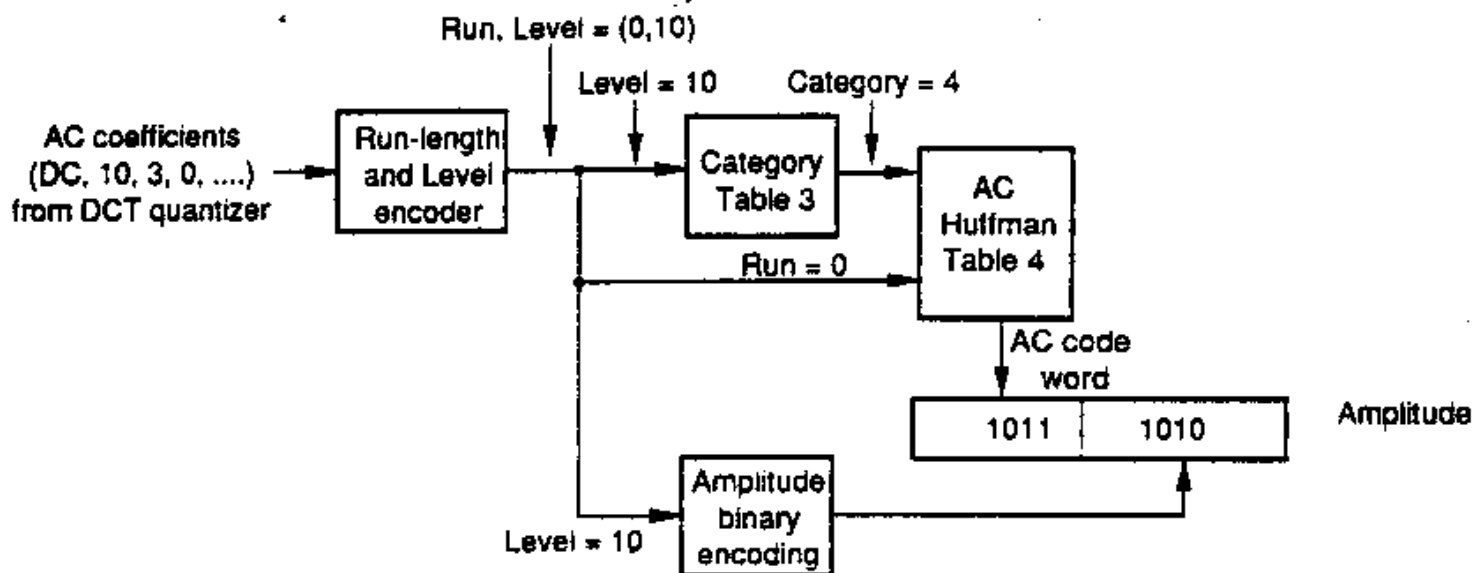
Differential DC values	Categories	Code word for luminance	Code word for chrominance
-255 to -128	8	1111 110	1111 1110
-127 to -64	7	1111 10	1111 110
-63 to -32	6	1111 0	1111 10
-31 to -16	5	1110	1111 0
-15 to -8	4	110	1110
-7 to -4	3	101	110
-3 to -2	2	01	10
-1	1	00	01
0	0	100	00
1	1	00	01
2 to 3	2	01	10
4 to 7	3	101	110
8 to 15	4	110	1110
16 to 31	5	1110	1111 0
32 to 63	6	1111 0	1111 10
64 to 127	7	1111 10	1111 110
128 to 255	8	1111 110	1111 1110

a) DC coefficient VLC encoding



(*) Category and DC Huffman binary numbers are shown in Table 8-3.

b) AC coefficient VLC encoding



(*) Category/run and AC Huffman binary numbers are shown in Tables 8-1 and 8-2.

Figure 8.20 DC and AC coefficient variable length/Huffman encoding (JPEG Baseline standard).

- Decodificador DCT - Transformada inversa

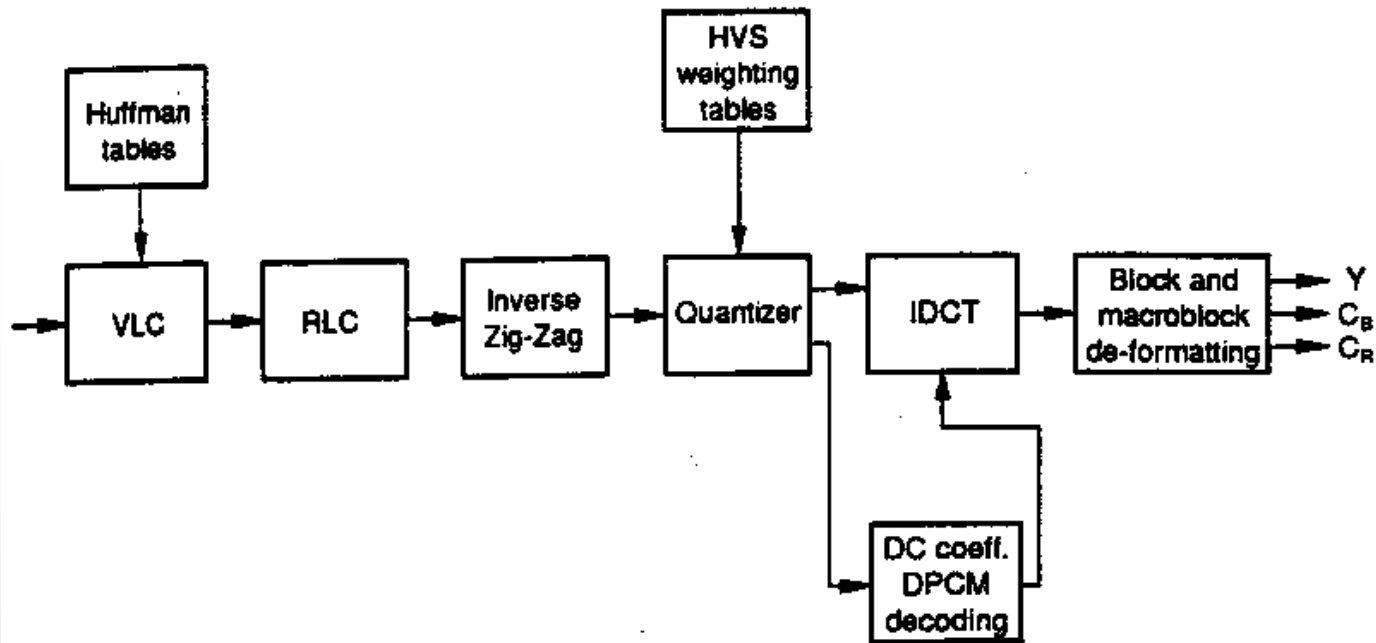


Figure 8.21 Basic DCT decoder.

$$f^*(j,k) = \frac{1}{4} \sum_{u=0}^7 \sum_{v=0}^7 C(u)C(v)F(u,v) \cos\left(\frac{(2j+1)u\pi}{16}\right) \cos\left(\frac{(2k+1)v\pi}{16}\right)$$

(Eq. 8.5)

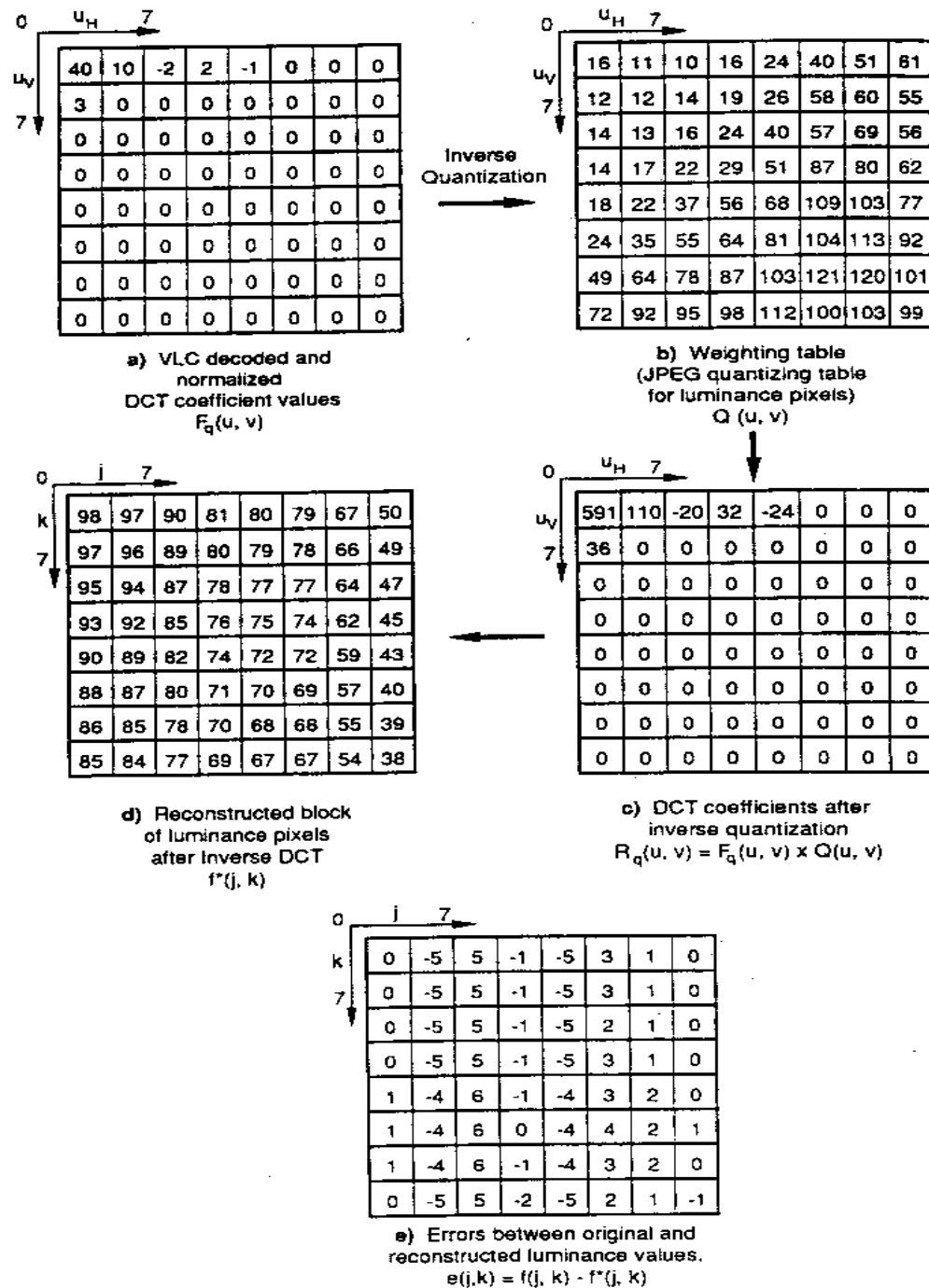


Figure 8.22 Inverse 8×8 DCT block process and resulting data errors. (Example #1).

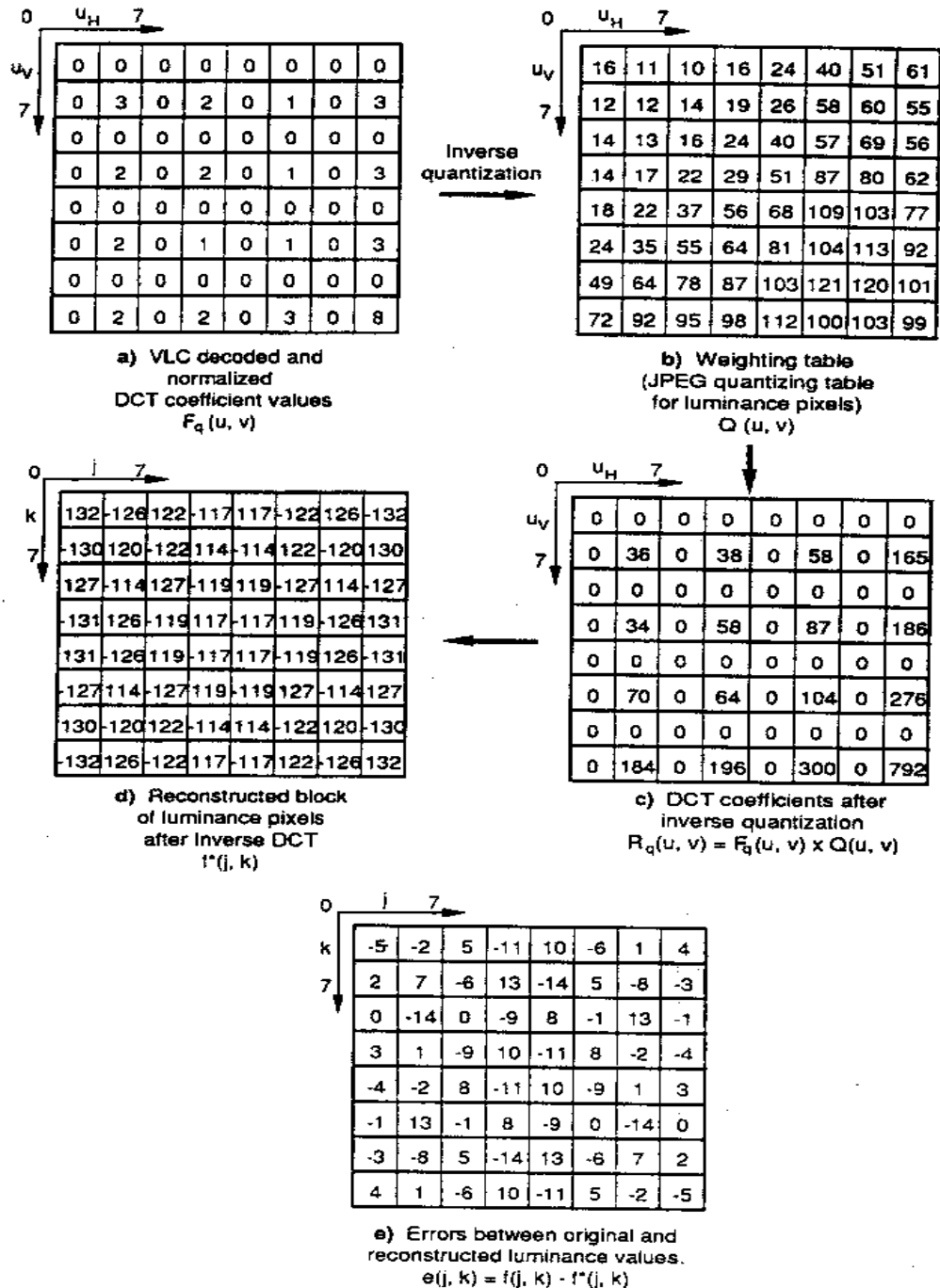


Figure 8.23 Inverse 8x8 DCT block process and resulting data errors. (Example #2: checkerboard picture).

Medición de los errores

- $e(j,k) = f(j,k) - f^*(j,k)$

$$RMSE = \sqrt{\frac{1}{64} \sum_{j=0}^7 \sum_{k=0}^7 e^2(j,k)}$$

Root-mean-squared error

$$PSNR = 20 \log_{10} \left(\frac{255}{RMSE} \right)$$

Picture Signal Noise Ratio

- En los ejemplos anteriores

- Ejemplo 1:

- $RMSE = 3.26$
 - $PSNR = 37.9 \text{ dB}$

- Ejemplo 2:

- $RMSE = 7.47$
 - $PSNR = 30.66 \text{ dB}$

Ejemplo de Codificación JPEG



Imagen Reconstruida por JPEG (~20:1)



Detalles de los Efectos de la Compresión

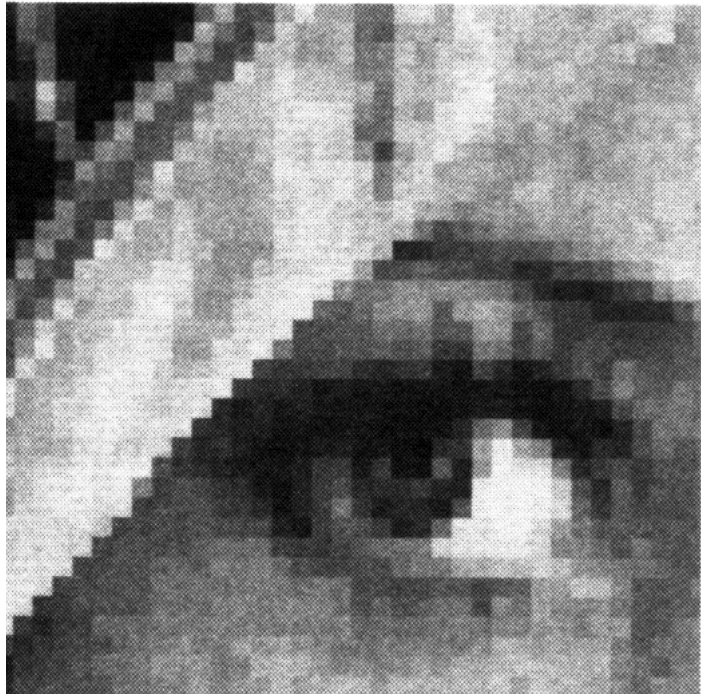


Imagen Original (40x40)

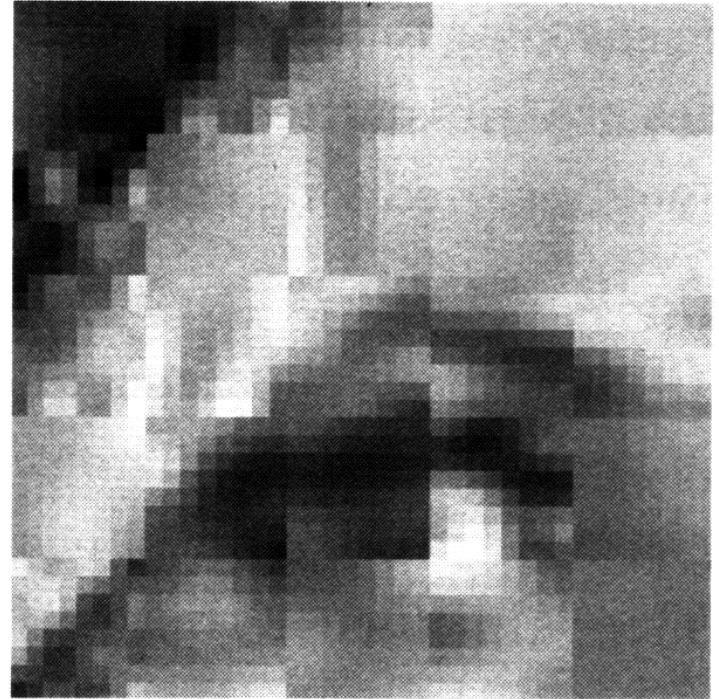
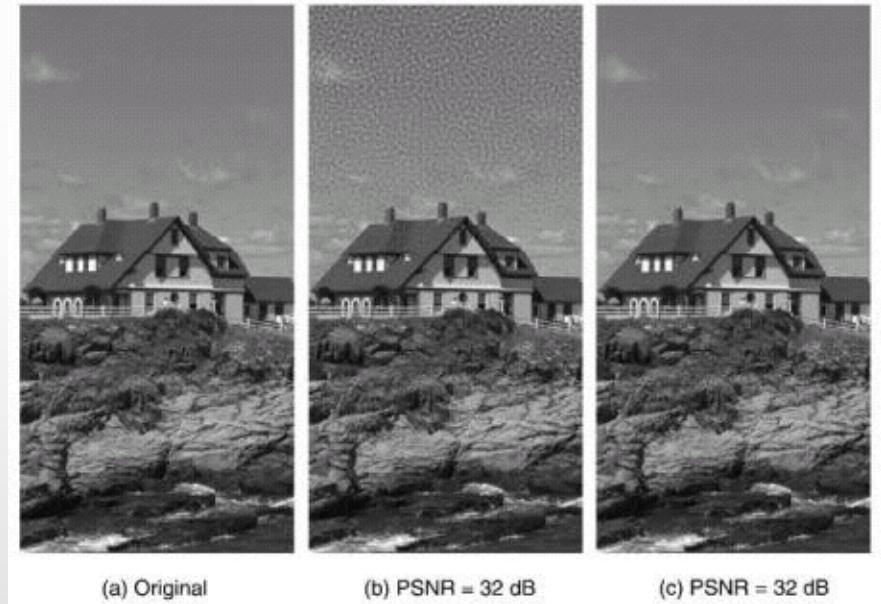


Imagen Comprimida ~20:1

RMSE y PSNR no se co-relacionan con la percepción humana



Izquierda: imagen original. Derecha: imagen degradada
Arriba: “Tiffany”, MSE=165; Medio: “Lago”, MSE=167
Abajo: “Mandrill”, MSE=163