

Redes de sensores inalámbricos (RSI)

Introducción a las RSI

Leonardo Steinfeld

Inst. de Ingeniería Eléctrica, Fac. de Ingeniería
Universidad de la República (Uruguay)



Co-funded by the
Erasmus+ Programme
of the European Union



FACULTAD DE
INGENIERÍA



UNIVERSIDAD
DE LA REPÚBLICA
URUGUAY

Disclaimer: The European Commission support for the production of this website does not constitute an endorsement of the contents which reflects the views only of the authors, and the Commission cannot be held responsible for any use which may be made of the information contained therein.

Objetivos / Agenda

- Objetivos
 - Introducir a los principales conceptos de RSI
- Agenda
 - Conceptos y definiciones de RSI
 - Elementos: nodos (nodo sensor, mote, mota, etc.)
 - Tecnologías de comunicaciones (opciones)

RSI: introducción

- ¿Qué son las redes de sensores inalámbricos?
 - sensores (también actuadores)
 - comunicación inalámbrica
 - redes: forman una red

RSI: otra aproximación...

- Twister (1996)

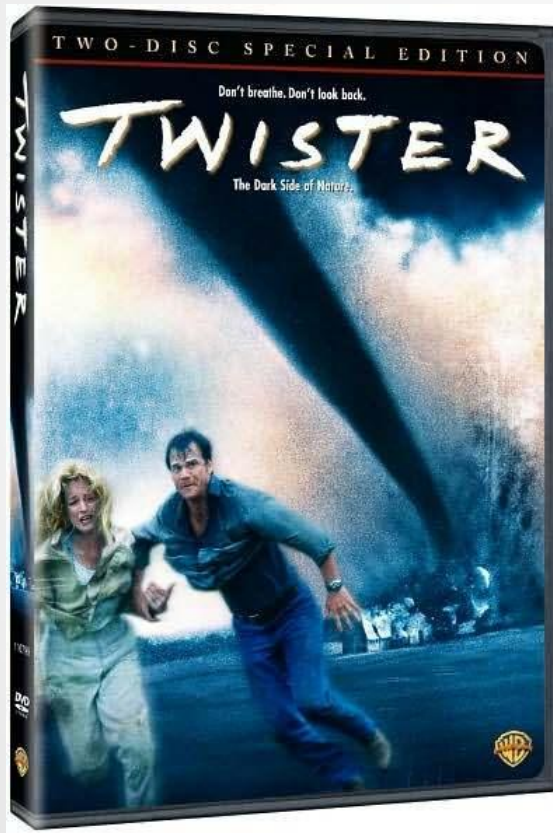

- Black Mirror (S03E06):
Hated in the Nation (2016)



RSI: características & desafíos

- Gran cantidad de sensores (decenas, cientos, ... miles)
 - múltiples consecuencias: costo, mantenimiento, etc.
- Características
 - Sistemas embebidos en red
 - Bajo consumo
 - Tolerante a fallos

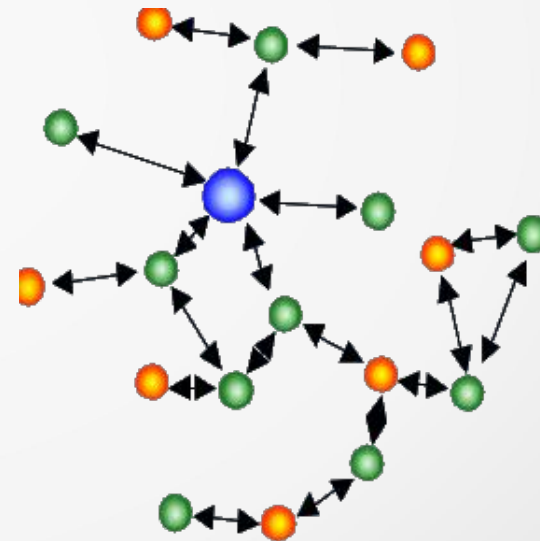

RSI: características & desafíos

- Red de comunicación
 - topología: estrella o malla
 - auto-organizadas
 - autónomas

Mesh Topology

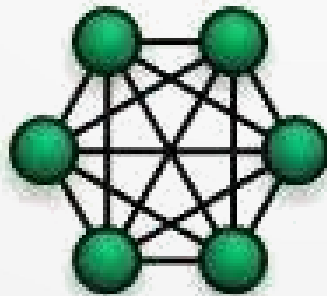

Star Topology

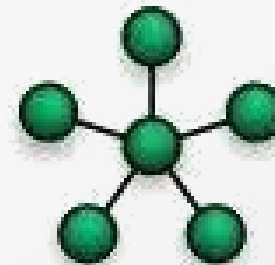

RSI: relación con IoT & LNN

- IoT según ITU-T
 - “A global infrastructure for the information society, enabling advanced services by interconnecting (physical and virtual) things based on existing and evolving interoperable information and communication technologies.” (“Overview of the Internet of things”, ITU-T (Y.4000/Y.2060) , 2012)
- IoT según IETF (LLN: Low power Lossy Network)
 - “Networks [...] composed of many embedded devices with limited power, memory, and processing resources interconnected by a variety of links. “ RFC 7102 (Jan. 2014)

Aplicaciones

- industrial monitoring
- building automation (heating, ventilation, air conditioning, lighting, access control, fire)
- connected home
- health care
- environmental monitoring
- urban sensor networks
- energy management
- assets tracking

RFC 7102 (Jan. 2014)

RSI: origen

“smart dust” (~2000)

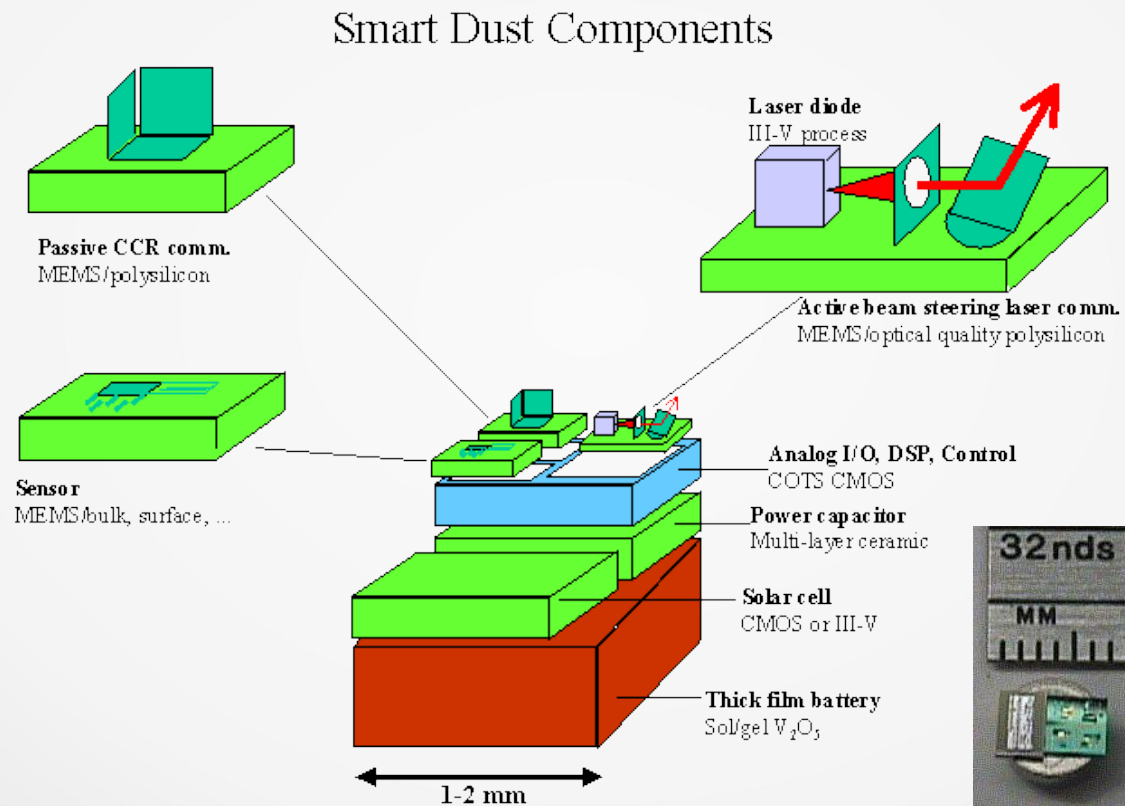

Fuente: <http://robotics.eecs.berkeley.edu/~pister/SmartDust/>

RSI: evolución Ley de Moore

Moore's Law – The number of transistors on integrated circuit chips (1971-2018)

Moore's law describes the empirical regularity that the number of transistors on integrated circuits doubles approximately every two years. This advancement is important as other aspects of technological progress – such as processing speed or the price of electronic products – are linked to Moore's law.

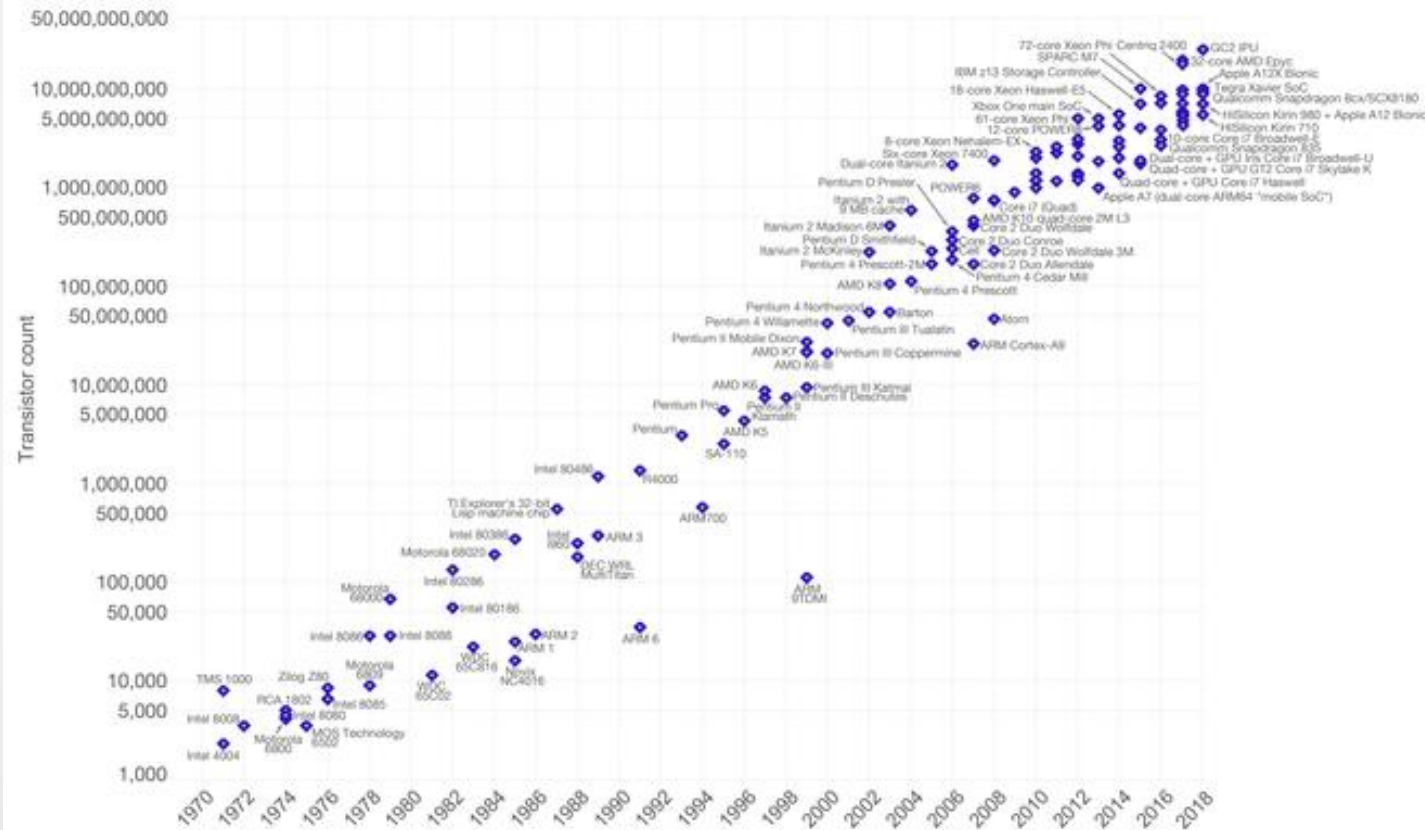

Data source: Wikipedia (https://en.wikipedia.org/wiki/Transistor_count)
 The data visualization is available at OurWorldInData.org. There you find more visualizations and research on this topic.

Licensed under CC-BY-SA by the author Max Roser.

RSI: ¿dónde estamos hoy?

- **TelosB /sky (2005)**
 - MSP430F1611 (8 MHz)
 - 10 KB RAM
 - 48 KB Flash
 - 4mA active / 10 uA sleep
 - CC2420
- **CCC2538 SoC (2013)**
 - Cortex M (32 MHz)
 - 32 KB RAM
 - 256 KB Flash
 - ~10 mA active / ~1uA sleep
 - “CC2520” integrado
- Ley de Moore: ¿en qué?

RSI: elementos / partes

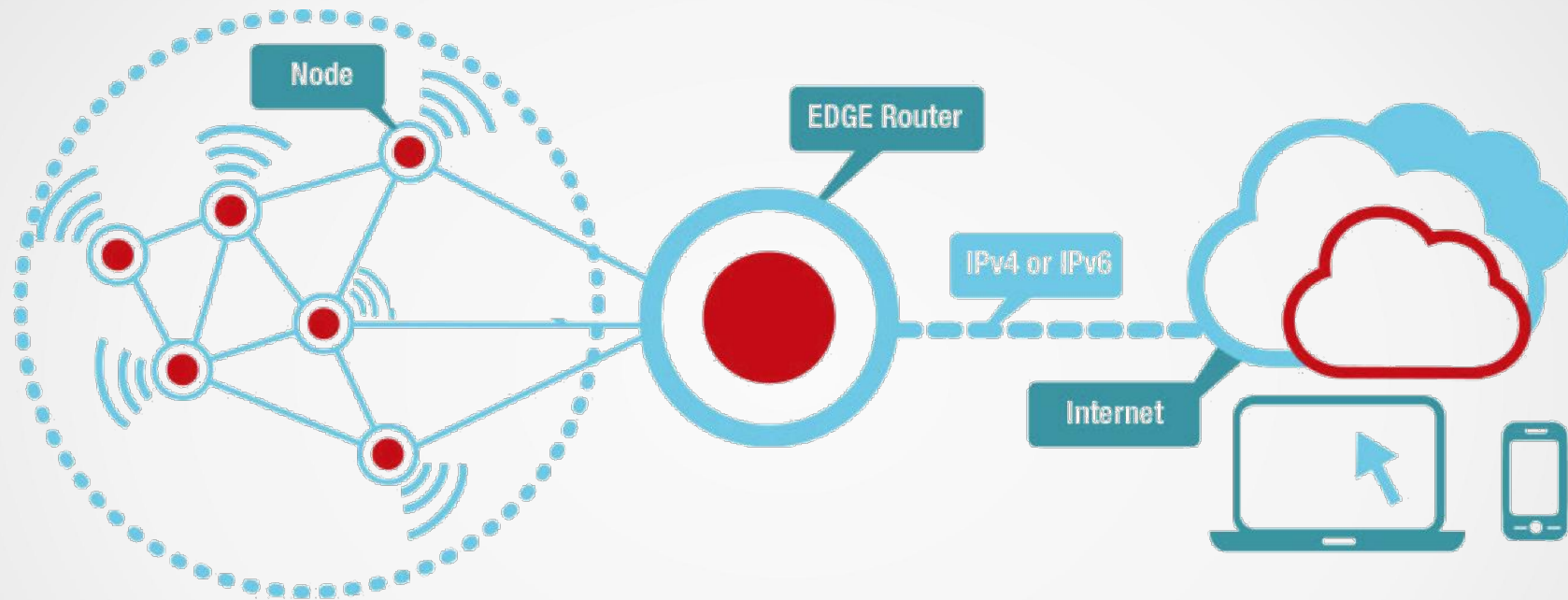

© IIE - Facultad de Ingeniería - UDELAR

RSI: elementos / partes



base



nodo sensor

red de sensores inalámbricos

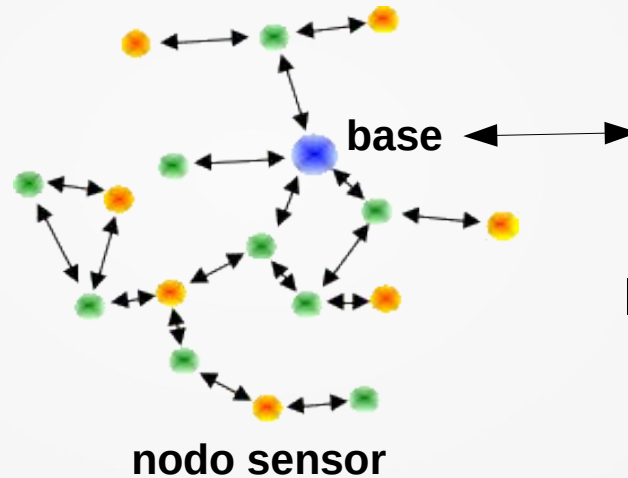

servidor (app/web)

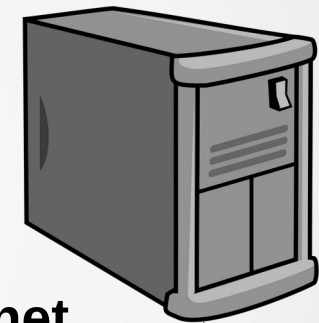

Internet

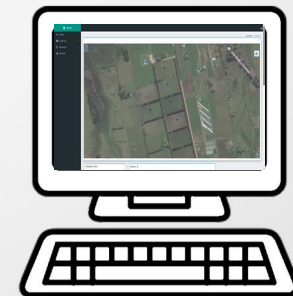

Nodos

- Características
 - bajo *todo*



costo



tamaño



consumo

- Componentes

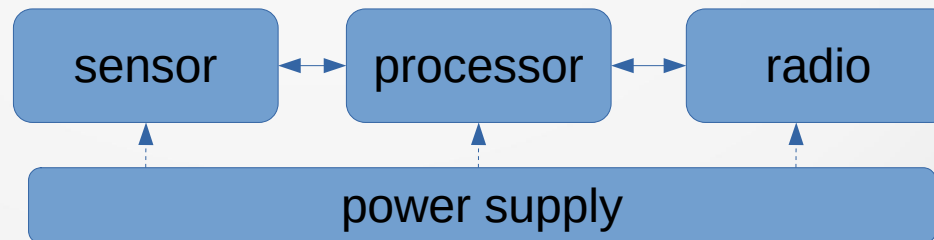

Nodos: sensores/actuadores

- transductor: magnitud física
- interfaz eléctrica
 - analógica: 0-5V, 4-20mA, etc.
 - digital: SPI, I2C, etc.
- calibración
 - parámetros

Nodos: microcontrolador

- Procesador: programable, periféricos y memoria integrada
- Funciones
 - input: señales de sensores / output: actuadores
 - procesamiento local de datos
 - ejecución de pila de comunicación

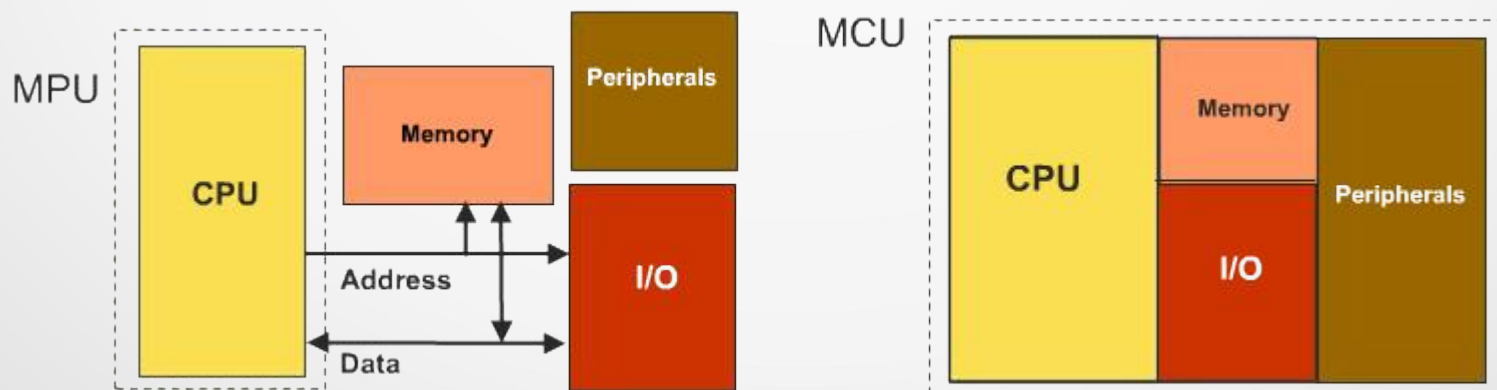

Nodos: transceptor (radio)

- Transmisor/ receptor: transceptor (capa física)
- Funciones cada vez más inteligentes
 - “modem” vs packet radio
 - pines para interrupción
- Interfaz: comunicación con uC
 - digital serie
 - mapeado en memoria (si está integrado)
- Tecnologías
 - **IEEE 802.15.4**, LoRa, Bluetooth, SigFox, NB-IoT, WiFi, etc.

Nodos: alimentación

- baterías
- recolección de energía
 - solar, térmica, vibraciones, radiofrecuencia, química
- híbridos
- Convertidores DC-DC
 - step-down
 - step-up

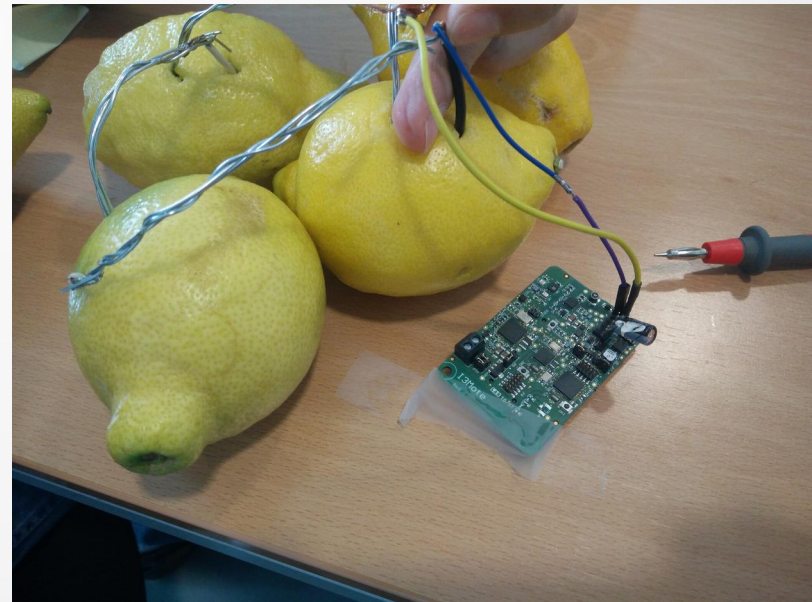

Tecnologías de comunicaciones



Clasificaciones de redes de com.

- LAN (Local)
- WLAN (Wireless Local)
- CAN (Campus)
- MAN (Metropolitana)
- WAN (Wide)
- **PAN** (Personal Area Network)
- **WPAN** (Wireless PAN) ← **RSI**
- **LPWAN** (Low Power WAN) ← **RSI**

Radio: bandas no licenciadas

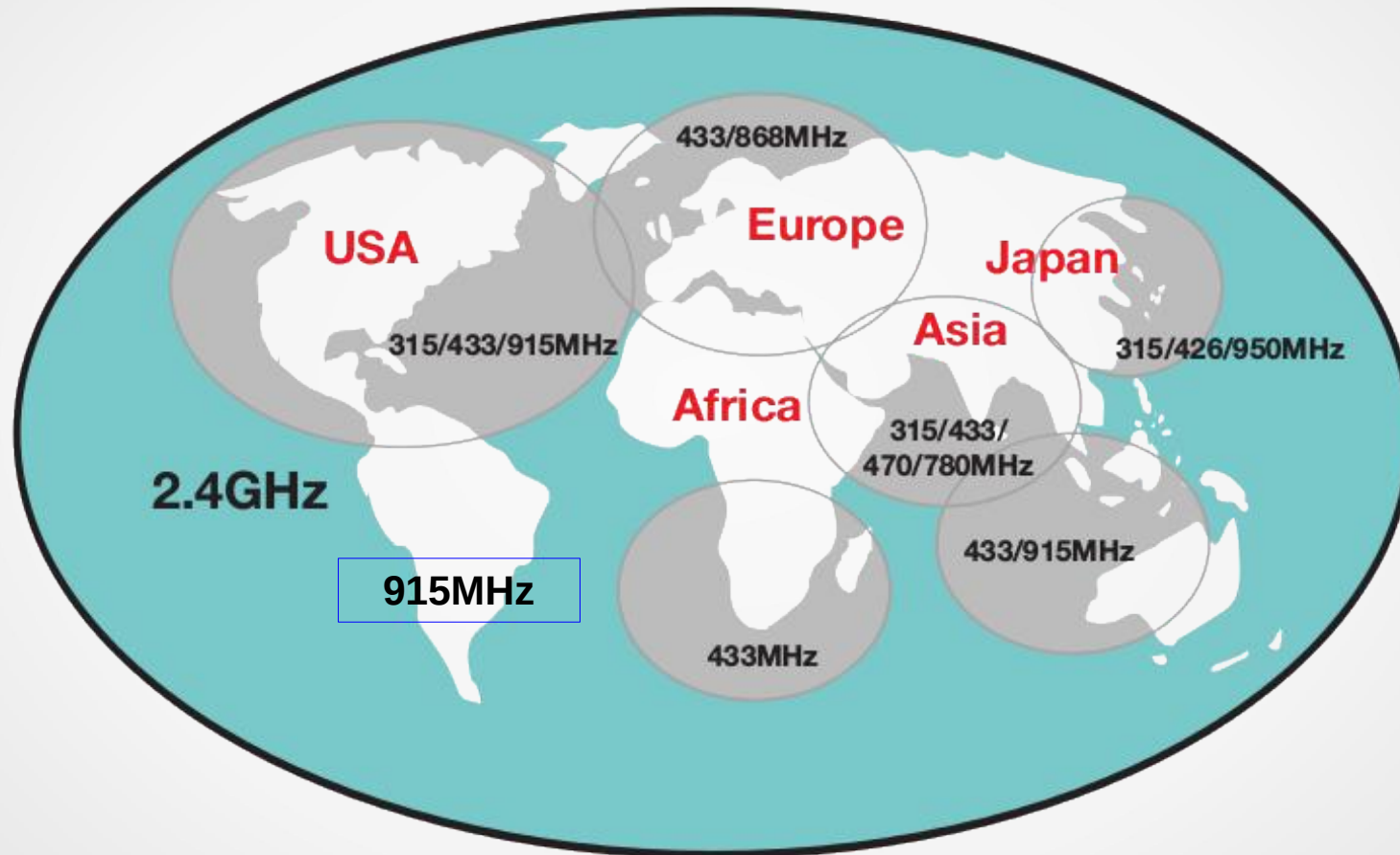

Tecnologías de comunicaciones

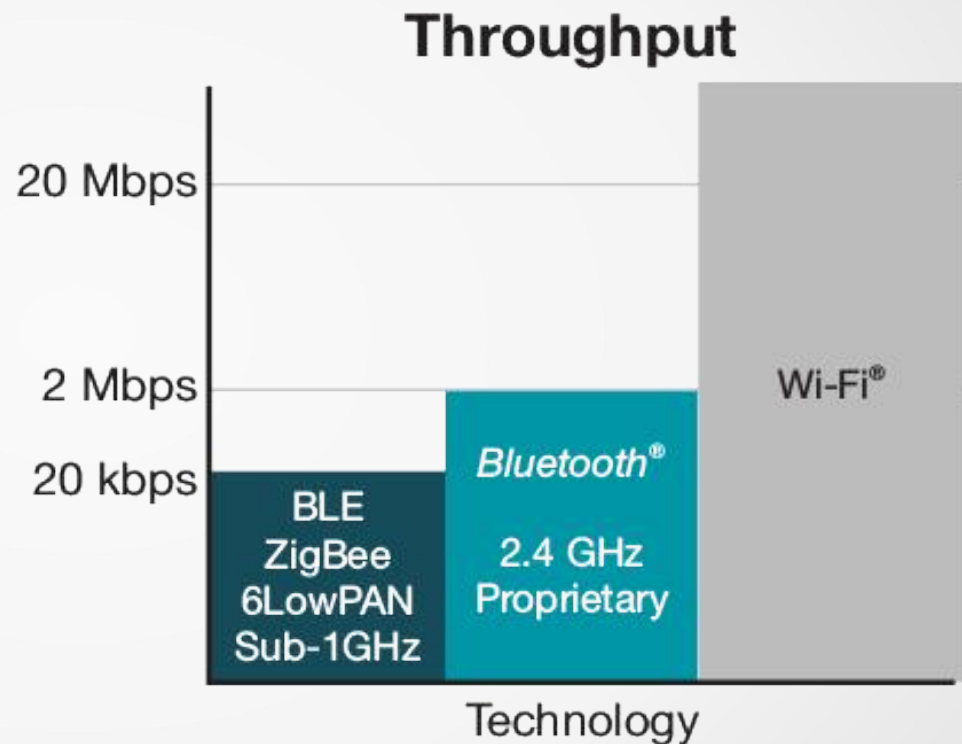
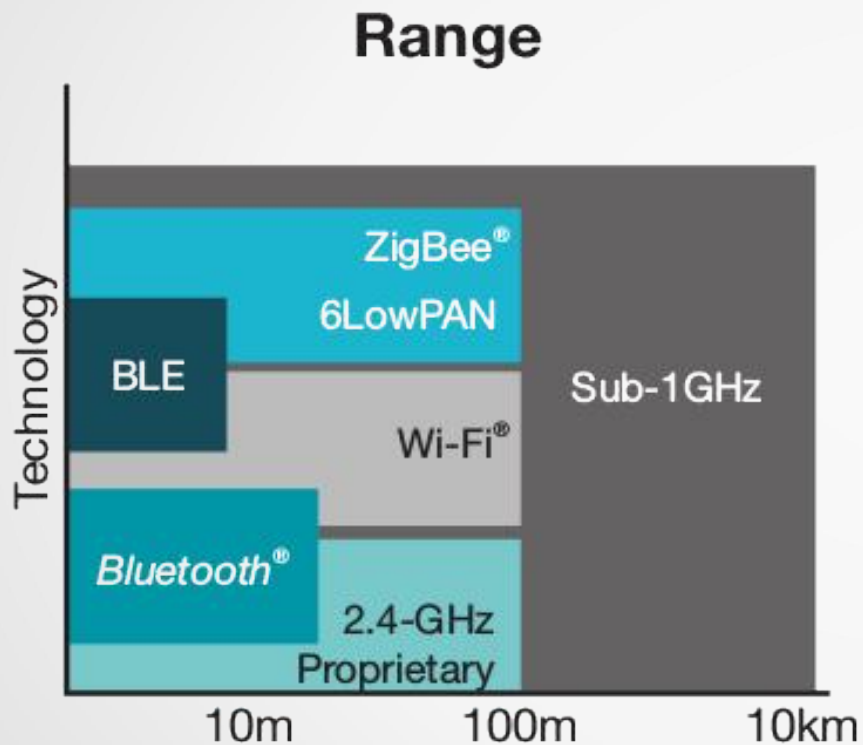

Tecnologías de comunicaciones

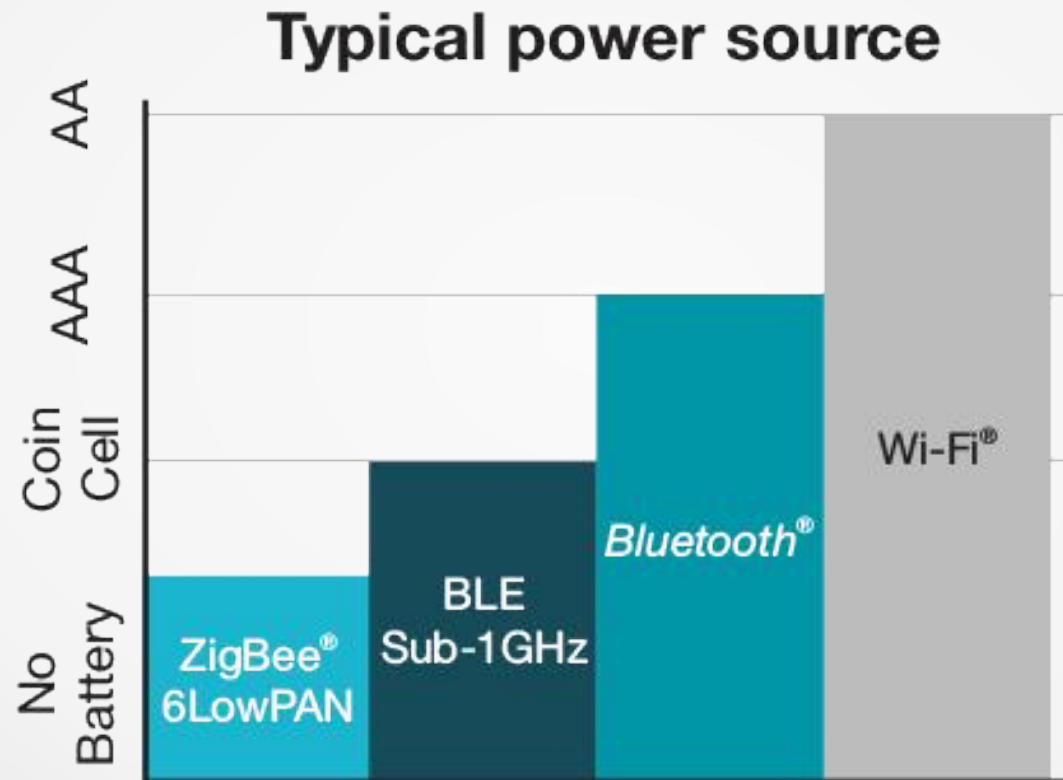

Arquitectura de comunicación

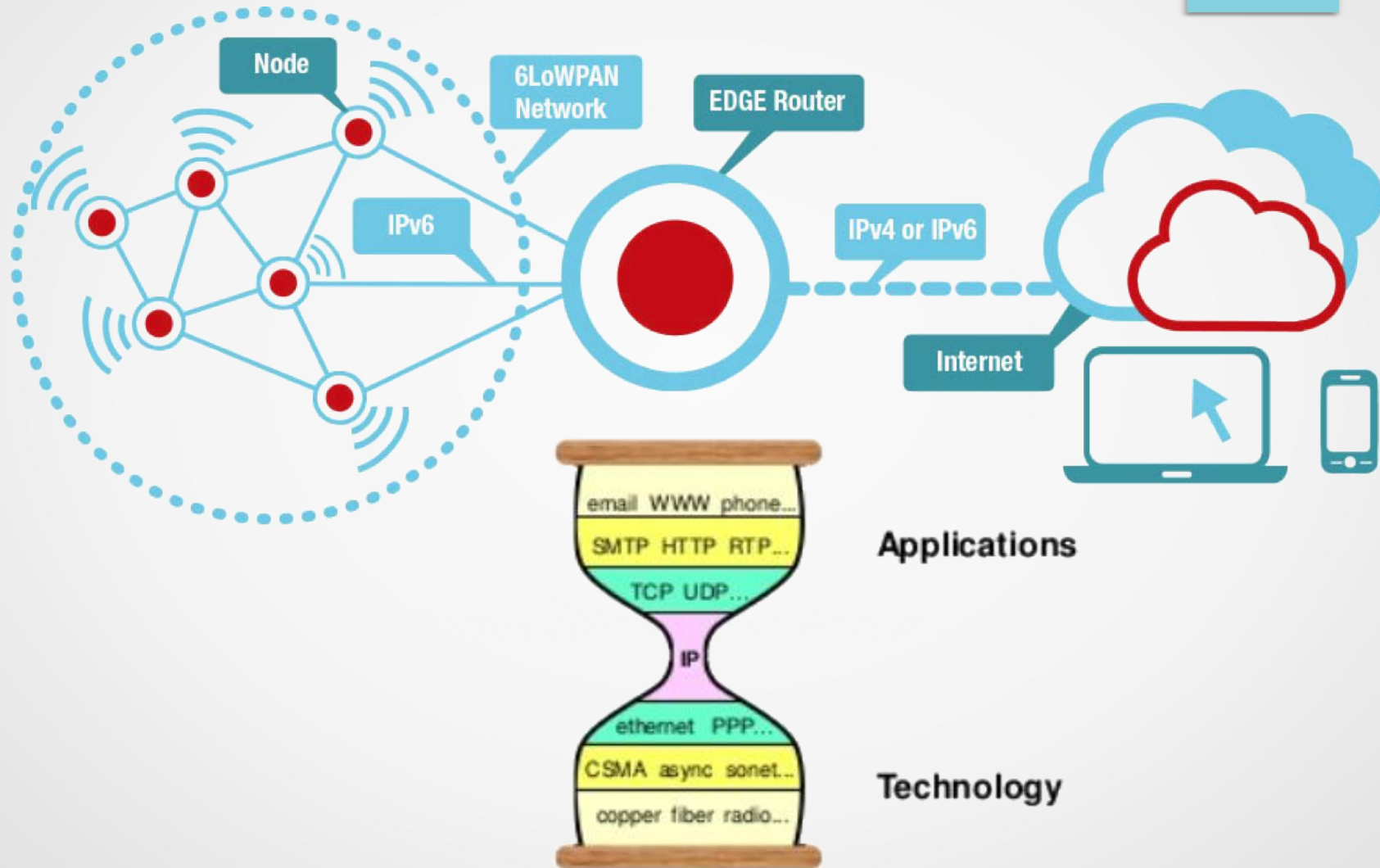

Pila abordada en el curso

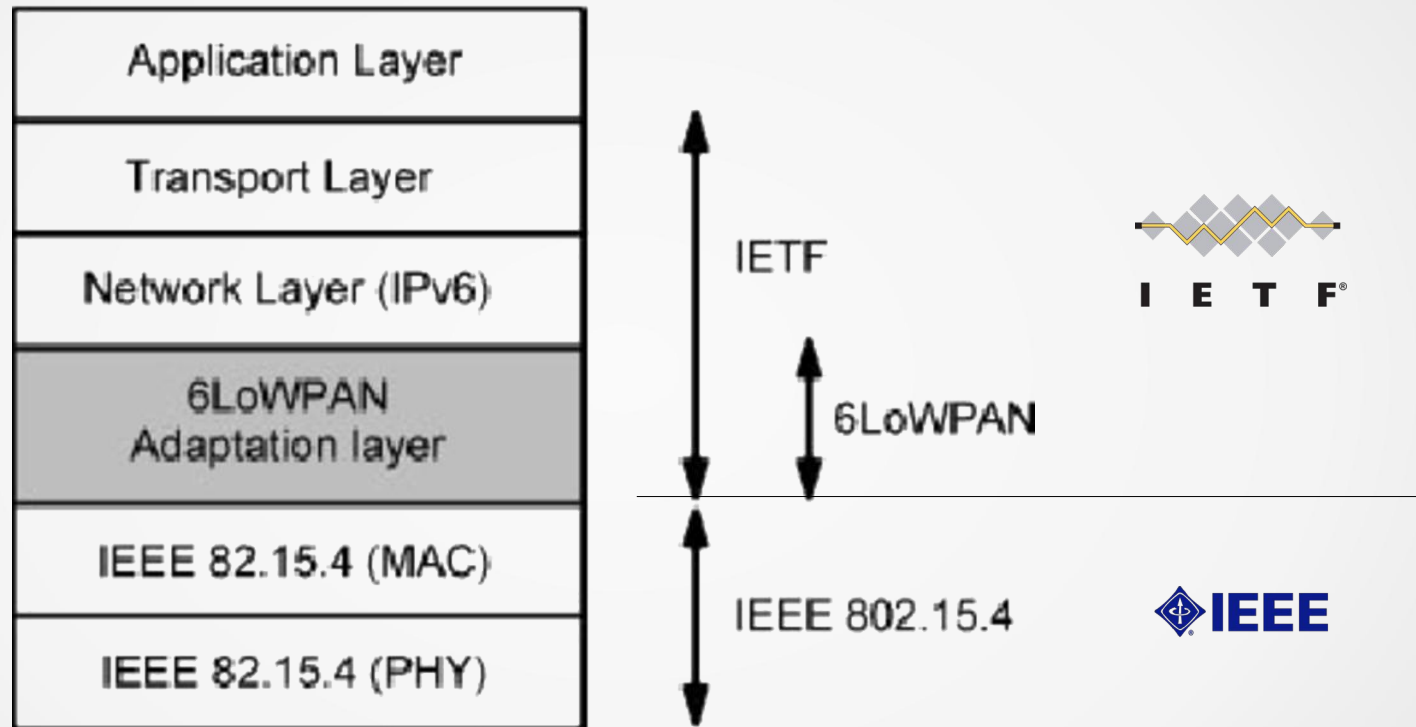

Pilas sobre IEEE 802.15.4

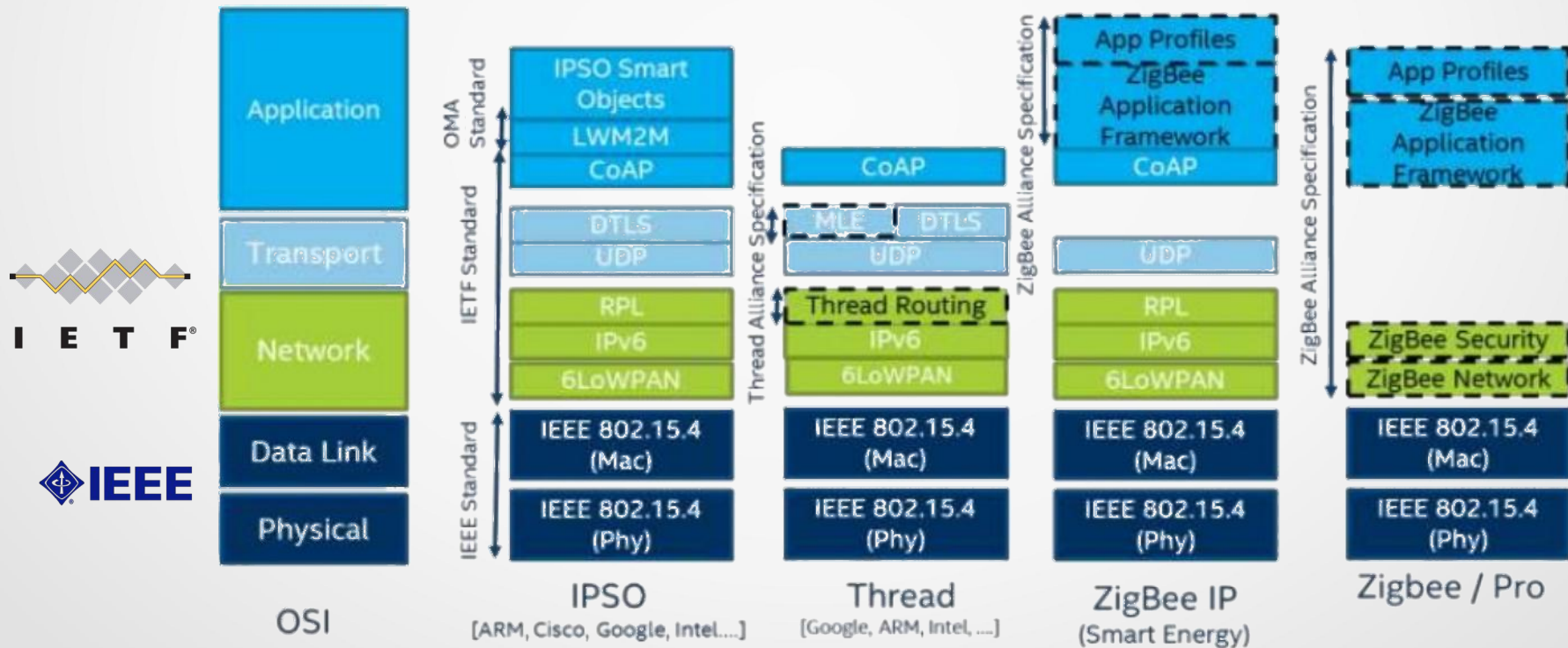
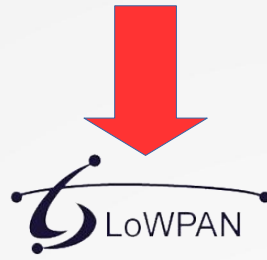

Pila de comunicación del curso

Layer	Protocol	Standard
Application	CoAP	IETF RFC 7252
Transport	UDP	IETF RFC 768
Network	IPv6 / RPL	IETF RFC 6550
Adaptation	6lowpan	IETF RFC 6282
Data link	IEEE 802.15.4 MAC (CSMA)	IEEE 802.15.4
Radio Duty Cycling	ContikiMAC	-
Physical	IEEE 802.15.4 PHY	IEEE 802.15.4

Planificación clases

- 1) **Introducción RSI**
- 2) Plataformas de hardware
- 3) Arquitectura 6LoWPAN (IPv6)
- 4) Plataforma de software: Contiki-NG (parte 1)
- 5) Plataforma de software: Contiki-NG (parte 2)
- 6) Capa de aplicación: CoAP / MQTT
- 7) Capa de red: RPL
- 8) MAC
- 9) IEEE 802.15.4 / 6lowpan
- 10) Capa Física & antenas
- 11) IoT y las RSI



¿más preguntas?