

BS170 / MMBF170 N-Channel Enhancement Mode Field Effect Transistor

General Description

These N-Channel enhancement mode field effect transistors are produced using Fairchild's proprietary, high cell density, DMOS technology. These products have been designed to minimize on-state resistance while provide rugged, reliable, and fast switching performance. They can be used in most applications requiring up to 500mA DC. These products are particularly suited for low voltage, low current applications such as small servo motor control, power MOSFET gate drivers, and other switching applications.

Features

- High density cell design for low $R_{DS(ON)}$.
- Voltage controlled small signal switch.
- Rugged and reliable.
- High saturation current capability.

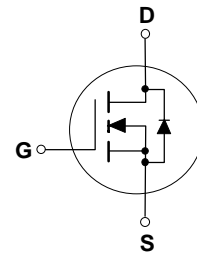
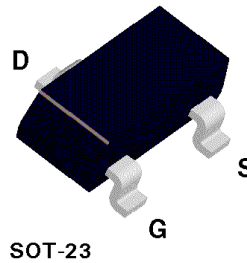
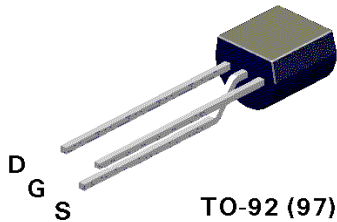

Absolute Maximum Ratings $T_A = 25^\circ\text{C}$ unless otherwise noted

Symbol	Parameter	BS170	MMBF170	Units
V_{DSS}	Drain-Source Voltage	60		V
V_{DGR}	Drain-Gate Voltage ($R_{GS} \leq 1M\Omega$)	60		V
V_{GSS}	Gate-Source Voltage	± 20		V
I_D	Drain Current - Continuous	500	500	mA
	- Pulsed	1200	800	
P_D	Maximum Power Dissipation	830	300	mW
	Derate Above 25°C	6.6	2.4	mW/ $^\circ\text{C}$
T_J, T_{STG}	Operating and Storage Temperature Range	-55 to 150		$^\circ\text{C}$
T_L	Maximum Lead Temperature for Soldering Purposes, 1/16" from Case for 10 Seconds	300		$^\circ\text{C}$

THERMAL CHARACTERISTICS

Symbol	Parameter	BS170	MMBF170	Units
$R_{\theta JA}$	Thermal Resistacne, Junction-to-Ambient	150	417	$^\circ\text{C}/\text{W}$

Electrical Characteristics ($T_A = 25^\circ\text{C}$ unless otherwise noted)

Symbol	Parameter	Conditions	Type	Min	Typ	Max	Units
OFF CHARACTERISTICS							
BV_{DSS}	Drain-Source Breakdown Voltage	$V_{GS} = 0\text{ V}, I_D = 100\ \mu\text{A}$	All	60			V
I_{DSS}	Zero Gate Voltage Drain Current	$V_{DS} = 25\text{ V}, V_{GS} = 0\text{ V}$	All			0.5	μA
I_{GSSF}	Gate - Body Leakage, Forward	$V_{GS} = 15\text{ V}, V_{DS} = 0\text{ V}$	All			10	nA
ON CHARACTERISTICS (Note 1)							
$V_{GS(th)}$	Gate Threshold Voltage	$V_{DS} = V_{GS}, I_D = 1\text{ mA}$	All	0.8	2.1	3	V
$R_{DS(on)}$	Static Drain-Source On-Resistance	$V_{GS} = 10\text{ V}, I_D = 200\text{ mA}$	All		1.2	5	Ω
g_{FS}	Forward Transconductance	$V_{DS} = 10\text{ V}, I_D = 200\text{ mA}$	BS170		320		mS
		$V_{DS} \geq 2 V_{DS(on)}, I_D = 200\text{ mA}$	MMBF170		320		
DYNAMIC CHARACTERISTICS							
C_{iss}	Input Capacitance	$V_{DS} = 10\text{ V}, V_{GS} = 0\text{ V},$ $f = 1.0\text{ MHz}$	All		24	40	pF
C_{oss}	Output Capacitance		All		17	30	pF
C_{rss}	Reverse Transfer Capacitance		All		7	10	pF
SWITCHING CHARACTERISTICS (Note 1)							
t_{on}	Turn-On Time	$V_{DD} = 25\text{ V}, I_D = 200\text{ mA},$ $V_{GS} = 10\text{ V}, R_{GEN} = 25\ \Omega$	BS170			10	ns
		$V_{DD} = 25\text{ V}, I_D = 500\text{ mA},$ $V_{GS} = 10\text{ V}, R_{GEN} = 50\ \Omega$	MMBF170			10	
t_{off}	Turn-Off Time	$V_{DD} = 25\text{ V}, I_D = 200\text{ mA},$ $V_{GS} = 10\text{ V}, R_{GEN} = 25\ \Omega$	BS170			10	ns
		$V_{DD} = 25\text{ V}, I_D = 500\text{ mA},$ $V_{GS} = 10\text{ V}, R_{GEN} = 50\ \Omega$	MMBF170			10	

Note:

 1. Pulse Test: Pulse Width $\leq 300\ \mu\text{s}$, Duty Cycle $\leq 2.0\%$.

Typical Electrical Characteristics

BS170 / MMBF170

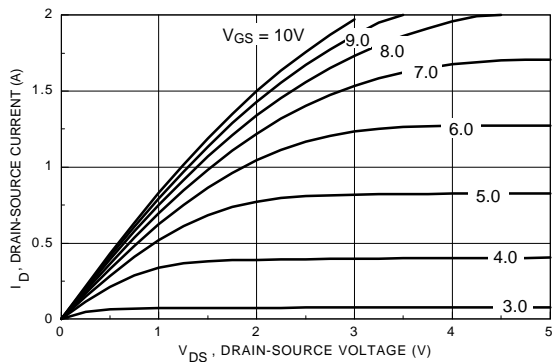

Figure 1. On-Region Characteristics.

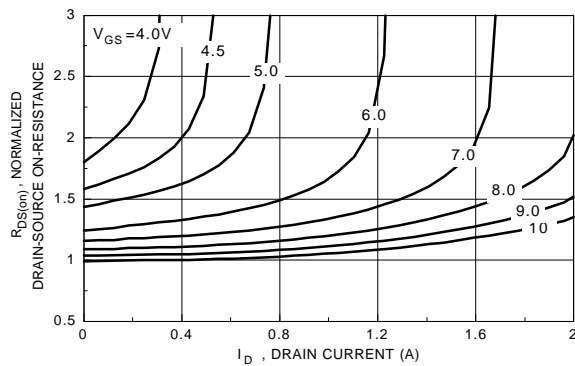

Figure 2. On-Resistance Variation with Gate Voltage and Drain Current.

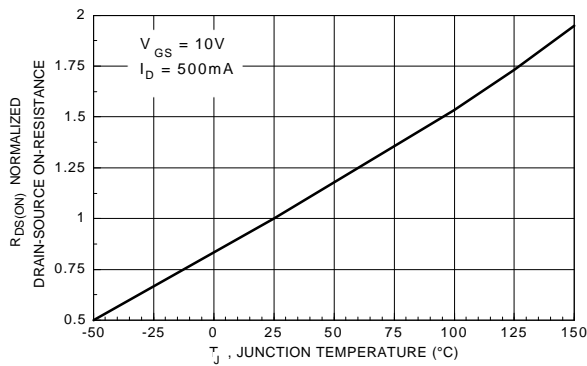

Figure 3. On-Resistance Variation with Temperature.

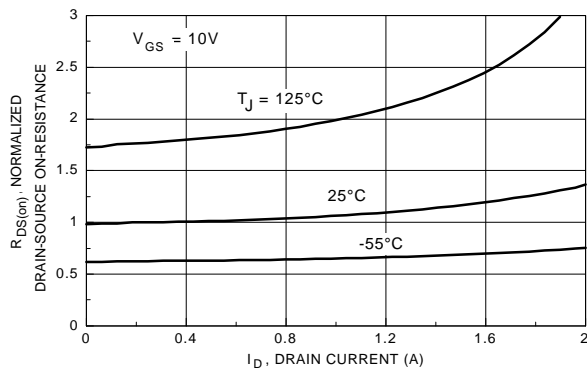

Figure 4. On-Resistance Variation with Drain Current and Temperature.

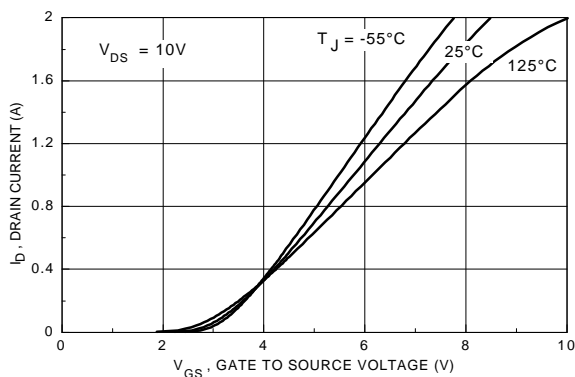

Figure 5. Transfer Characteristics.

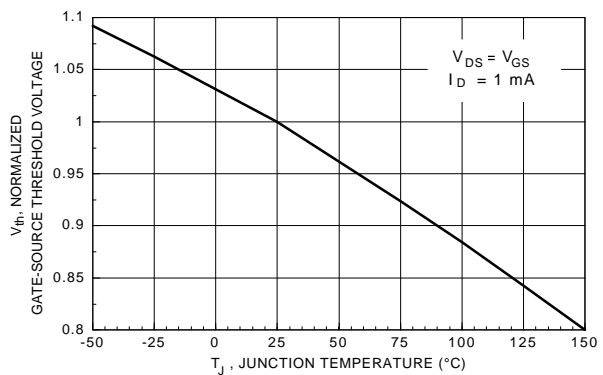

Figure 6. Gate Threshold Variation with Temperature.

Typical Electrical Characteristics (continued)

BS170 / MMBF170

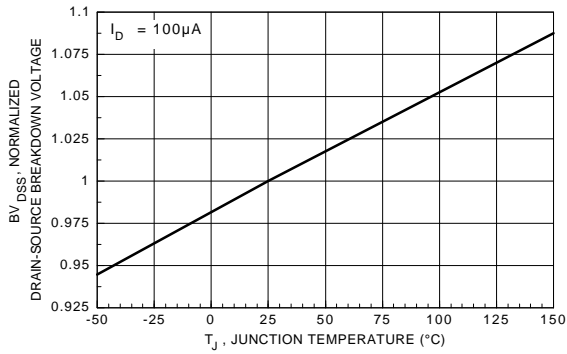

Figure 7. Breakdown Voltage Variation with Temperature.

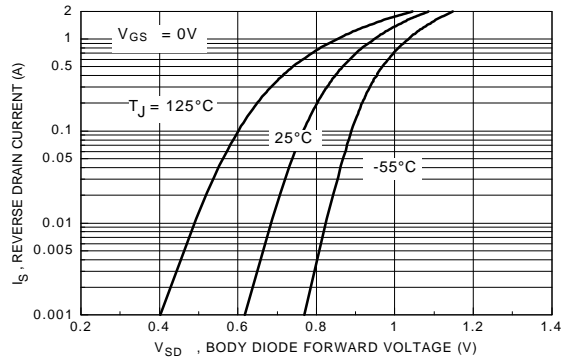

Figure 8. Body Diode Forward Voltage Variation with Current and Temperature.

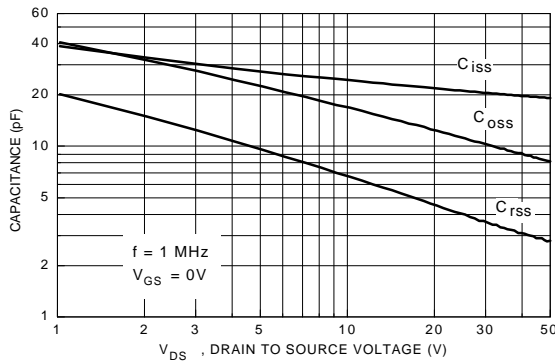

Figure 9. Capacitance Characteristics.

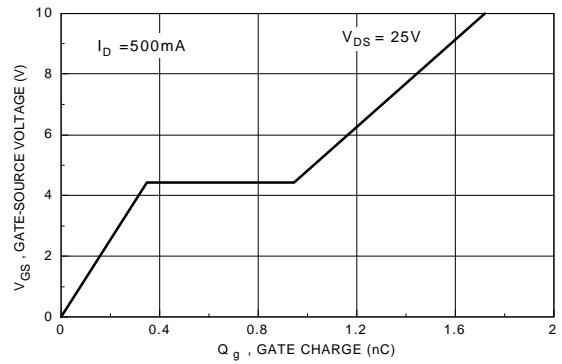

Figure 10. Gate Charge Characteristics.

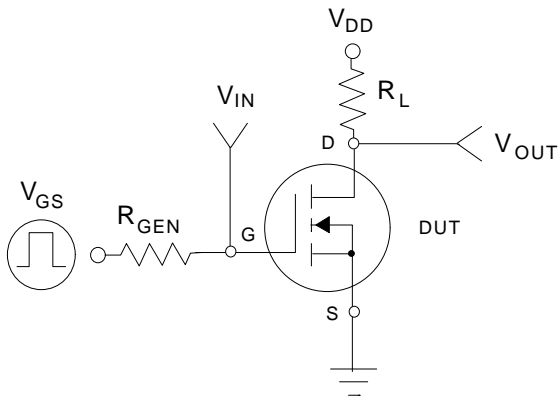

Figure 11. Switching Test Circuit.

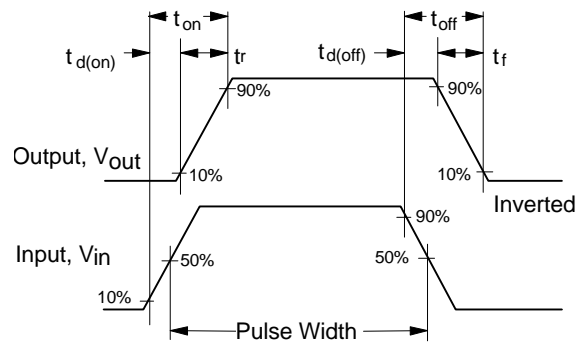

Figure 12. Switching Waveforms.

Typical Electrical Characteristics (continued)

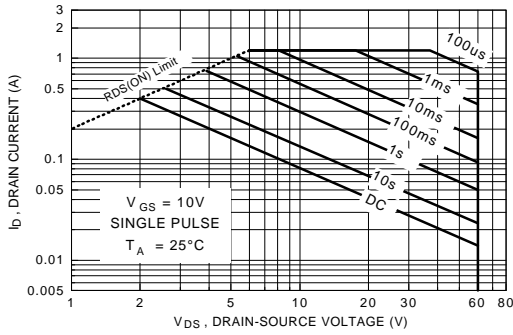

Figure 13. BS170 Maximum Safe Operating Area.

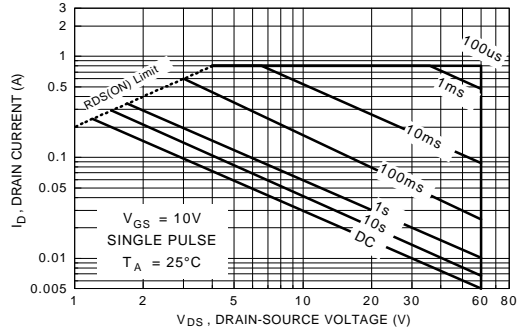

Figure 14. MMBF170 Maximum Safe Operating Area.

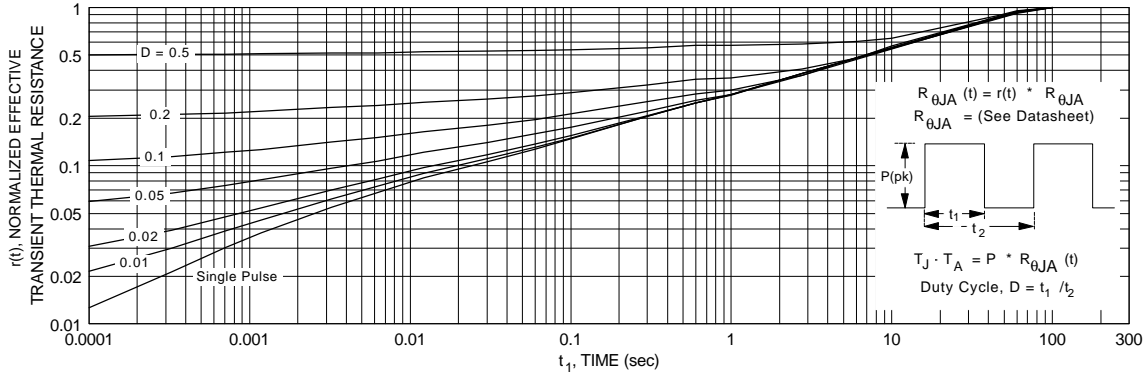

Figure 15. TO-92, BS170 Transient Thermal Response Curve.

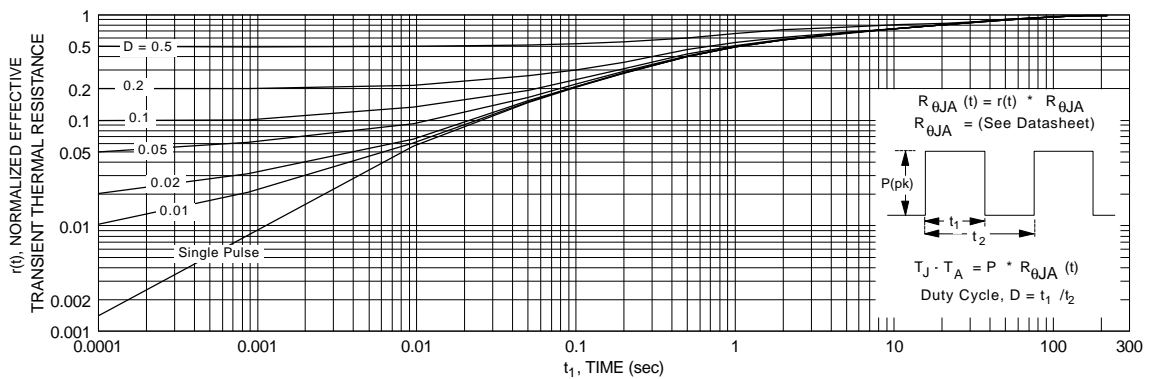

Figure 16. SOT-23, MMBF170 Transient Thermal Response Curve.